

ECMA

Standardizing Information and Communication Systems

**Private Integrated Services Network
(PISN) -
Specification, Functional Model and
Information Flows -
Recall Supplementary Service**

ECMA

Standardizing Information and Communication Systems

**Private Integrated Services Network
(PISN) -
Specification, Functional Model and
Information Flows -
Recall Supplementary Service**

(RESD)

Brief History

This Standard is one of a series of ECMA Standards defining services and signalling protocols applicable to Private Integrated Services Networks (PISNs). The series uses ISDN concepts as developed by ITU-T and conforms to the framework of International Standards for Open Systems Interconnection as defined by ISO/IEC.

This particular Standard specifies the Recall supplementary service.

This Standard is based upon the practical experience of ECMA member companies and the results of their active and continuous participation in the work of ISO/IEC JTC1, ITU-T, ETSI and other international and national standardization bodies. It represents a pragmatic and widely based consensus.

Compared to the 1st Edition of Standard ECMA-213 (published by ECMA in December 1994), the 2nd Edition (published by ECMA in June 1997) incorporated changes in order to achieve complete alignment with International Standard ISO/IEC 15051:1997(E) published by ISO/IEC in May 1997.

Table of contents

1	Scope	1
2	Conformance	1
3	References (normative)	1
4	Definitions	1
4.1	External definitions	1
4.2	Other definitions	2
4.2.1	Busy	2
4.2.2	Call, basic call	2
4.2.3	Recall busy	2
4.2.4	Recall busy timer	3
4.2.5	Recall no answer	3
4.2.6	Recall no answer timer	3
4.2.7	Served user	3
4.2.8	Waiting at busy user	3
5	List of acronyms	3
6	SS-RE stage 1 specification	3
6.1	Description	3
6.1.1	General description	3
6.1.2	Qualifications on applicability to telecommunication services	3
6.2	Procedures	4
6.2.1	Provision/withdrawal	4
6.2.2	Normal procedures	4
6.2.3	Exceptional procedures	4
6.3	Interactions with other supplementary services and ANFs	5
6.3.1	Calling line identification presentation (SS-CLIP)	5
6.3.2	Connected line identification presentation (SS-COLP)	5
6.3.3	Calling/connected line identification restriction (SS-CLIR)	5
6.3.4	Calling name identification presentation (SS-CNIP)	5
6.3.5	Connected name identification presentation (SS-CONP)	5
6.3.6	Calling/connected name identification restriction (SS-CNIR)	5
6.3.7	Call forwarding unconditional (SS-CFU) and Call deflection immediate (SS-CDI)	5
6.3.8	Call forwarding busy (SS-CFB)	5
6.3.9	Call forwarding no reply (SS-CFNR) and Call deflection from alerting (SS-CDA)	5
6.3.10	Do-not-disturb (SS-DND)	5
6.3.11	Do-not-disturb override (SS-DNDO)	5
6.3.12	Call completion to busy subscriber (SS-CCBS)	5
6.3.13	Call completion on no reply (SS-CCNR)	5
6.3.14	Call offer (SS-CO)	6

6.3.15	Call transfer (SS-CT)	6
6.3.16	Path replacement (ANF-PR)	6
6.3.17	Call intrusion (SS-CI)	6
6.3.18	Advice of charge (SS-AOC)	6
6.3.19	Call interception (ANF-CINT)	6
6.4	Interworking considerations	6
6.5	Overall SDL	6
7	SS-RE stage 2 specification	8
7.1	Functional model	8
7.1.1	Functional model description	8
7.1.2	Description of functional entities	8
7.1.3	Relationship of functional model to basic call functional model	8
7.2	Information flows	9
7.2.1	Definition of information flows	9
7.2.2	Relationship of information flows to Basic Call information flows	9
7.2.3	Example of information flow sequences	10
7.3	Functional entity actions	10
7.3.1	Functional entity actions of FE1	10
7.3.2	Functional entity actions of FE2	10
7.3.3	Functional entity actions of FE3	11
7.3.4	Functional entity actions of FE4	11
7.4	Functional entity behaviour	11
7.4.1	Behaviour of FE1	11
7.4.2	Behaviour of FE2	11
7.4.3	Behaviour of FE3	13
7.4.4	Behaviour of FE4	13
7.5	Allocation of functional entities to physical equipment	14

1 Scope

This Standard specifies supplementary service Recall (SS-RE), which is applicable to various basic services supported by Private Integrated Services Networks (PISN). Basic services are specified in ECMA-142.

SS-RE is a supplementary service which provides for the redirection of a call transferred by the served user back to the served user if the call is unanswered. SS-RE is only applicable after transfer by join, not after transfer by rerouting.

Service specifications are produced in three stages, according to the method described in ETS 300 387. This Standard contains the stage 1 and stage 2 specifications of SS-RE. The stage 1 specification (clause 6) specifies the supplementary service as seen by users of PISNs. The stage 2 specification (clause 7) identifies the functional entities involved in the supplementary service and the information flows between them.

2 Conformance

In order to conform to this Standard, a Stage 3 standard shall specify signalling protocols and equipment behaviour that are capable of being used in a PISN which supports the supplementary service specified in this Standard. This means that, to claim conformance, a Stage 3 standard is required to be adequate for the support of those aspects of clause 6 (stage 1) and clause 7 (stage 2) which are relevant to the interface or equipment to which the Stage 3 standard applies.

3 References (normative)

The following standards contain provisions which, through reference in this text, constitute provisions of this Standard. All standards are subject to revision, and parties to agreements based on this Standard are encouraged to investigate the possibility of applying the most recent editions of the standards indicated below.

In the case of references to ECMA Standards that are aligned with ISO/IEC International Standards, the number of the appropriate ISO/IEC International Standard is given in brackets after the ECMA reference.

ECMA-133	Private Integrated Services Network (PISN) - Reference Configuration for PISN Exchanges (PINX) (International Standard ISO/IEC 11579-1)
ECMA-142	Private Integrated Services Network (PISN) - Circuit-mode 64 kbit/s Bearer Services - Service Description, Functional Capabilities and Information Flows (International Standard ISO/IEC 11574)
ECMA-177	Private Integrated Services Network (PISN) - Specification, Functional Model and Information Flows - Call Transfer Supplementary Service (International Standard ISO/IEC 13865)
ETS 300 387	Private Telecommunication Network (PTN); Method for the specification of basic and supplementary services (1994)
ITU-T Rec. I.112	Vocabulary of terms for ISDNs (1993)
ITU-T Rec. I.210	Principles of telecommunication services supported by an ISDN and the means to describe them (1993)
ITU-T Rec. I.221	Common specific characteristics of services (1993)
ITU-T Rec. Z.100	Specification and description language (1999)

4 Definitions

For the purposes of this Standard, the following definitions apply.

4.1 External definitions

This Standard uses the following terms defined in other documents:

- Basic Service (ITU-T Rec. I.210)

- Connection (ITU-T Rec. I.112)
- Network Determined User Busy (ITU-T Rec. I.221)
- Primary Call (ECMA-177)
- Private Integrated Services Network (PISN) (ECMA-133)
- Private Integrated services Network eXchange (PINX) (ECMA-133)
- Secondary Call (ECMA-177)
- Service (ITU-T Rec. I.112)
- Signalling (ITU-T Rec. I.112)
- Supplementary Service (ITU-T Rec. I.210)
- User (ECMA-142)
- User A (ECMA-177)
- User B (ECMA-177)
- User C (ECMA-177)
- User Determined User Busy (ITU-T Rec. I.221)

This Standard refers to the following basic call functional entities (FEs) defined in ECMA-142:

- Call Control (CC)
- Call Control Agent (CCA)

This Standard refers to the following basic call inter-FE relationships defined in ECMA-142:

- r1
- r2
- r3

This Standard refers to the following basic call information flows defined in ECMA-142:

- Report request/indication
- Setup request/indication
- Setup response/confirmation

This Standard refers to the following basic call information flow elements defined in ECMA-142:

- Connected Number (CN)
- Connected Subaddress (CS)

4.2 Other definitions

4.2.1 Busy

A property of a user for whom either a Network Determined User Busy or a User Determined User Busy condition exists.

4.2.2 Call, basic call

An instance of the use of a basic service.

4.2.3 Recall busy

The redirection of a transferred call back to the served user if the call is waiting at a busy user C and user C remains busy.

4.2.4 Recall busy timer

A timer governing the period that a transferred call will wait at a busy user C before Recall busy occurs. The value of this timer is implementation specific.

4.2.5 Recall no answer

The redirection of a transferred call back to the served user if user C is being alerted and does not answer.

4.2.6 Recall no answer timer

A timer governing the period that a transferred call will alert user C before Recall no answer occurs. The value of this timer is implementation specific.

4.2.7 Served user

A User A that is provided with SS-RE.

4.2.8 Waiting at busy user

A call state in which a call is awaiting answer at a user that is busy on another call.

NOTE

This can arise, for example, as a result of the use of supplementary service Call Offer (SS-CO) during call establishment. A call that is waiting on busy can be transferred.

5 List of acronyms

ANF	Additional Network Feature
CC	Call Control (functional entity)
CCA	Call Control Agent (functional entity)
CN	Connected Number
CS	Connected Subaddress
DC	Destination Category
FE	Functional Entity
ISDN	Integrated Services Digital Network
PINX	Private Integrated services Network eXchange
PISN	Private Integrated Services Network
SDL	Specification and Description Language
SS-RE	Supplementary Service Recall
TE	Terminal Equipment

6 SS-RE stage 1 specification

6.1 Description

6.1.1 General description

When the served user has a call established with user B and transfers that call to user C, SS-RE enables user B to be re-connected to the served user either if user C is being alerted and does not reply within a specified period (recall no answer), or if the call is waiting at busy user C and user C remains busy for a specified period (recall busy). An implementation may provide either of these variants or both.

NOTE

If the served user fails to respond to the incoming re-directed call, the call may be cleared or subjected to other action which is beyond the scope of this specification.

6.1.2 Qualifications on applicability to telecommunication services

SS-RE is applicable to all basic services defined in ECMA-142.

6.2 Procedures

6.2.1 Provision/withdrawal

SS-RE may be provided after pre-arrangement with the service provider, or may be available generally to all users. SS-RE may be withdrawn on request of the user or for administrative reasons.

The subscription parameters and values offered by a PISN shall be an implementation matter. A PISN may offer more or less parameters and values than those specified below.

Table 1 - SS-RE Subscription parameters

Subscription option	Value
Recall no answer	select or de-select
Recall busy	select or de-select

6.2.2 Normal procedures

6.2.2.1 Activation/deactivation/registration/interrogation

Not applicable.

6.2.2.2 Invocation and operation

SS-RE may be invoked by the PISN on behalf of the served user in conjunction with a call transfer, if the secondary call is not in the active state.

NOTE

The invocation of SS-RE may be dependent upon call type and/or other factors that are beyond the scope of this Standard.

If the secondary call is waiting at busy user C at the time of call transfer and if Recall busy is applicable, then the recall busy timer shall be started. If user C becomes not busy and starts to be alerted before the recall busy timer expires, Recall busy shall be cancelled.

If user C is being alerted at the time of call transfer, or was busy and subsequently starts to be alerted, and if Recall no answer is applicable, then the recall no answer timer shall be started.

For both Recall busy and Recall no answer, if user C answers within the recall timer limit SS-RE shall be cancelled.

If the recall busy timer expires before user C accepts the call or starts to be alerted, or the recall no answer timer expires before user C accepts the call, then the primary call shall be redirected to the served user, and user B's connection with user C shall be cleared either immediately or when the served user starts to be alerted. The served user shall receive a notification that recall takes place, together with the recall reason plus the identity of user C, if available and presentation is not restricted. If user C's number is not available or its presentation is restricted, the original called number of the secondary call shall be indicated instead.

User B shall be notified when recall takes place and, if the served user is being alerted, also when the served user answers; the notification shall include the served user's identity, unless presentation is restricted and user B has no override capability.

6.2.3 Exceptional procedures

6.2.3.1 Activation/deactivation/registration/interrogation

Not applicable.

6.2.3.2 Invocation and operation

If the redirection of the primary call fails, e.g. because the served user is busy, the transferred call may continue waiting at user C or alerting user C, whichever is applicable. If it does not continue, or if the served user does not answer the incoming redirected call, additional means to complete the call may be provided as an implementation option.

NOTE

These additional means are beyond the scope of this Standard.

6.3 Interactions with other supplementary services and ANFs

Interactions with other supplementary services and ANFs for which PISN standards were available at the time of publication of this Standard are specified below.

6.3.1 Calling line identification presentation (SS-CLIP)

When recall busy or no answer takes place user B's identity shall be presented to the served user by means of SS-CLIP, provided no restriction applies.

6.3.2 Connected line identification presentation (SS-COLP)

No interaction.

6.3.3 Calling/connected line identification restriction (SS-CLIR)

If SS-CLIR applies to any of the involved users' number this number shall not be presented in the context of SS-RE, unless the receiving user has override capability.

6.3.4 Calling name identification presentation (SS-CNIP)

When recall busy or no answer takes place user B's name shall, if available, be presented to the served user by means of SS-CNIP, provided no restriction applies.

6.3.5 Connected name identification presentation (SS-CONP)

No interaction.

6.3.6 Calling/connected name identification restriction (SS-CNIR)

If SS-CNIR applies to user B's name this name shall not be presented in the context of SS-RE, unless the served user has override capability.

6.3.7 Call forwarding unconditional (SS-CFU) and Call deflection immediate (SS-CDI)

No interaction if SS-CFU or SS-CDI is invoked at user C.

SS-RE may override SS-CFU if activated at the served user. If SS-RE does not override SS-CFU then no SS-CFU information shall be indicated to the calling user (user B).

No interaction if SS-CDI is invoked at the served user.

6.3.8 Call forwarding busy (SS-CFB)

No interaction if SS-CFB is activated at user C.

SS-RE may override SS-CFB if activated at the served user. If SS-RE does not override SS-CFB then no SS-CFB information shall be indicated to the calling user (user B).

6.3.9 Call forwarding no reply (SS-CFNR) and Call deflection from alerting (SS-CDA)

If SS-CFNR or SS-CDA is invoked at user C, SS-RE shall be cancelled. SS-RE may be re-invoked against the new user C (i.e. the diverted-to user).

No interaction if SS-CFNR or SS-CDA is invoked at the served user.

6.3.10 Do-not-disturb (SS-DND)

SS-RE may override SS-DND, if active at the served user.

6.3.11 Do-not-disturb override (SS-DNDO)

No interaction.

6.3.12 Call completion to busy subscriber (SS-CCBS)

No interaction.

6.3.13 Call completion on no reply (SS-CCNR)

No interaction.

6.3.14 Call offer (SS-CO)

A call transfer occurring after successful invocation of SS-CO on the secondary call and before completion of SS-CO may lead to the invocation of SS-RE (recall busy).

6.3.15 Call transfer (SS-CT)

This interaction is specified in 6.2.2.2 and 6.2.3.2.

6.3.16 Path replacement (ANF-PR)

No interaction.

6.3.17 Call intrusion (SS-CI)

A call transfer occurring after reaching the Call-Intrusion-Wait-On-Busy state on the secondary call, but before completion of SS-CI, may lead to the invocation of SS-RE (recall busy).

6.3.18 Advice of charge (SS-AOC)

No interaction.

6.3.19 Call interception (ANF-CINT)

A call redirected as a result of SS-RE may be subject to interception.

NOTE

ANF-CINT can be used instead of SS-RE, e.g. in case of transfer by rerouting.

6.4 Interworking considerations

The operation of SS-RE is independent of the location of user C, however, due to interworking the number of user C may not be available when notifying user A of the occurrence of recall. In that case the original called number of the secondary call shall be presented.

SS-RE can be provided to user A also in the case that user B is in another network. The PISN shall send any notifications associated with recall to the other network if that network is capable of receiving them.

If user B is in the PISN and the PISN receives notifications from another network that provides a service similar to SS-RE, the notifications shall be passed on to user B.

6.5 Overall SDL

Figure 1 contains the dynamic description of SS-RE using the Specification and Description Language (SDL) defined in ITU-T Rec. Z.100. The SDL process represents the behaviour of the network in providing SS-RE. The relationship of this process to the basic call process is indicated in the annotations.

Output signals to the left represent primitives to user A.

Input signals from the right represent inputs from the basic call process, or inputs from an internal process.

Output signals to the right represent primitives to user B.

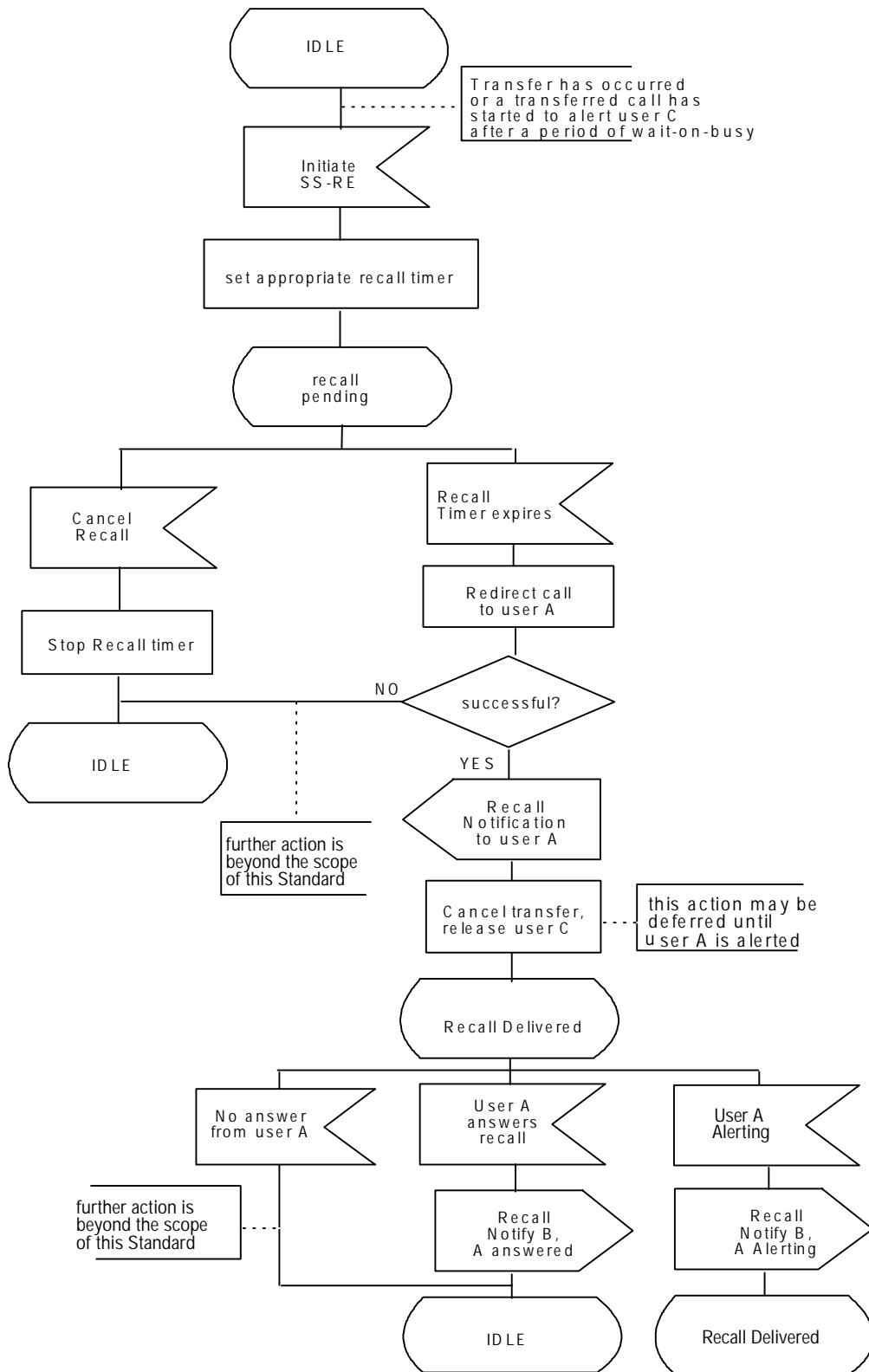

Figure 1 - SS-RE, Overall SDL

7 SS-RE stage 2 specification

7.1 Functional model

7.1.1 Functional model description

The functional model shall comprise the following functional entities (FEs):

- FE1 Served user's service agent
- FE2 Recall Execute entity
- FE3 Recall Status Receive entity
- FE4 Transferred user's service agent

The following functional relationships shall exist between these FEs:

- rw between FE1 and FE2
- rx between FE2 and FE3 and between FE3 and FE4

Figure 2 shows these FEs and relationships.

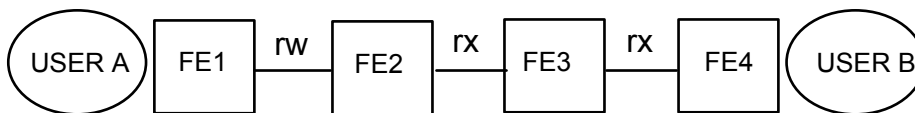

Figure 2 - Functional model for SS-RE

7.1.2 Description of functional entities

7.1.2.1 Served user's service agent functional entity FE1

This functional entity receives on behalf of the served user the indication that an incoming call has been re-directed as a result of recall timer expiry.

7.1.2.2 Recall Execute functional entity FE2

This functional entity is responsible for the recall timing function and for redirection of the transferred call to the served user when the recall timer expires. FE2 informs FE3 that the served user is being alerted and/or has answered after recall has occurred.

7.1.2.3 Recall Status Receive functional entity FE3

This functional entity receives the information flow indicating the alerting/answered state of the served user after recall has occurred and passes this information on to FE4.

7.1.2.4 Transferred user's service agent functional entity FE4

This functional entity informs the transferred user that recall has occurred.

7.1.3 Relationship of functional model to basic call functional model

An example of a relationship between the FEs for SS-RE and FEs for the basic call is shown in figure 3.

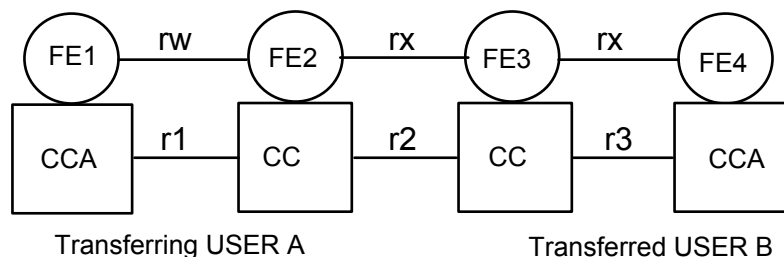

Figure 3 - Example relationship between the model for SS-RE and the Basic Call Model

7.2 Information flows

7.2.1 Definition of information flows

In the tables listing the elements in information flows, the column headed "Request" indicates which of these elements are mandatory (M) and which are optional (O) in a request/indication information flow.

7.2.1.1 rw_Inform

rw_Inform is an unconfirmed information flow across rw from FE2 to FE1 which informs the served user that the incoming call is recalling.

Table 2 lists the elements within the rw_Inform information flow.

Table 2 - Content of rw_Inform

Element	Request
Unanswered Number (Note 1)	M
Recall Reason (Note 2)	M
Note 1 This element contains user C's number if known and not restricted, or the called number otherwise. Note 2 Allowed values are 'busy' and 'no answer'.	

7.2.1.2 rx_Inform1

rx_Inform1 is an unconfirmed information flow from FE2 to FE3 and from FE3 to FE4 which is used to indicate that Recall has occurred and that user A is alerting.

Table 3 lists the elements within the rx_Inform1 information flow.

Table 3 - Content of rx_Inform1

Element	Request
Alerted Number	O
Alerted Name	O

7.2.1.3 rx_Inform2

rx_Inform2 is an unconfirmed information flow from FE2 to FE3 and from FE3 to FE4 which is used to indicate that user A has answered.

Table 4 lists the elements within the rx_Inform2 information flow.

Table 4 - Content of rx_Inform2

Element	Request
Connected Number (CN)	M
Connected Subaddress (CS)	O
Connected Name	O

7.2.2 Relationship of information flows to Basic Call information flows

rw_Inform request/indication shall be sent with r1_SETUP request/indication.

All other information flows shall be sent independently of basic call information flows.

7.2.3 Example of information flow sequences

A stage 3 standard for SS-RE shall provide signalling procedures in support of the information flow sequence specified below. In addition, signalling procedures should be provided to cover other sequences arising from error situations, interactions with basic call, interactions with other supplementary services and ANFs, different topologies, etc..

In the figure, SS-RE information flows are represented by solid arrows and basic call information flows are represented by broken arrows. An ellipse embracing two information flows indicates that the two information flows occur simultaneously. Within a column representing an SS-RE functional entity, the numbers refer to functional entity actions listed in 7.3.

7.2.3.1 Normal operation of SS-RE

Figure 4 shows the information flow sequence for normal operation of SS-RE following a transfer initiated by user A.

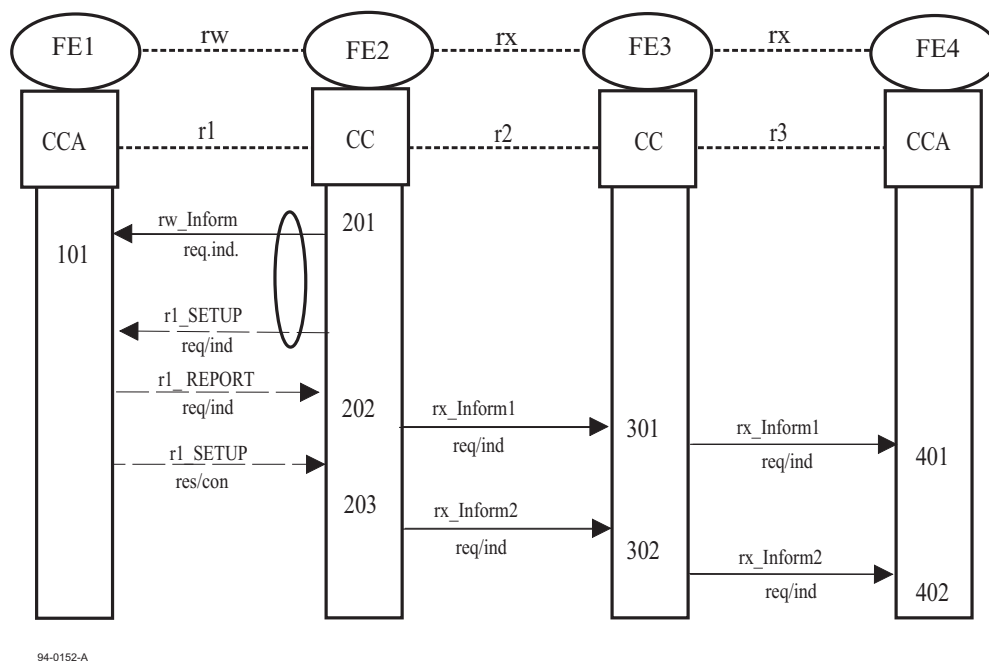

94-0152-A

Figure 4 - Information flow sequence - Normal operation of SS-RE

7.3 Functional entity actions

The following FE actions shall occur at the points indicated in figure 4.

7.3.1 Functional entity actions of FE1

101 Deliver SS-RE notifications to the user as received from FE2 in *rw_Inform*.

7.3.2 Functional entity actions of FE2

201 On receipt of an indication that the transferred call is alerting or waiting at busy user C, start the appropriate SS-RE timer.

As soon as the alerting or wait-on-busy condition ceases for any reason, stop the SS-RE timer and terminate SS-RE.

Following expiry of the recall timer, send the *rw_Inform* request/indication information flow to FE1 with basic call flow *r1_SETUP* request/indication, and optionally cancel the transfer process and disconnect the call to user C.

202 On receipt of *r1_REPORT* request/indication send *rx_Inform1* request/indication to FE3 and disconnect the call to user C, if not already done.

203 On receipt of r1_SETUP response/confirmation send rx_Inform2 request/indication to FE3.

7.3.3 Functional entity actions of FE3

301 Receive rx_Inform1 request/indication from FE2, and send rx_Inform1 request/indication to FE4.

302 Receive rx_Inform2 request/indication from FE2, and send rx_Inform2 request/indication to FE4.

7.3.4 Functional entity actions of FE4

401 Deliver SS-RE notification and alerted party information to user B as received from FE3 in rx_Inform1.

402 Deliver SS-RE notification and connected party information to user B as received from FE3 in rx_Inform2.

7.4 Functional entity behaviour

The FE behaviours shown below are intended to illustrate typical FE behaviour in terms of information flows sent and received.

The behaviour of each FE is shown using the Specification and Description Language (SDL) defined in ITU-T Rec. Z.100.

7.4.1 Behaviour of FE1

Figure 5 shows the normal behaviour of FE1. Output signals to the left represent primitives to user A. Input signals from the right represent information flows from FE2.

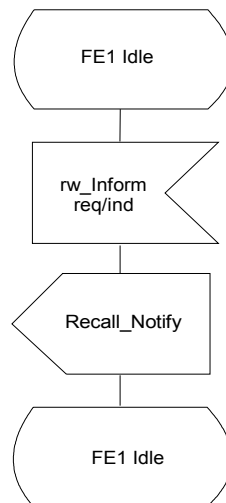

Figure 5 - SS-RE SDL for functional entity FE1

7.4.2 Behaviour of FE2

Figure 6 shows the behaviour of FE2. Output symbols to the left represent information flows to FE1. Input symbols from the right represent internal stimuli or stimuli from basic call. Output signals to the right represent information flows to FE3.

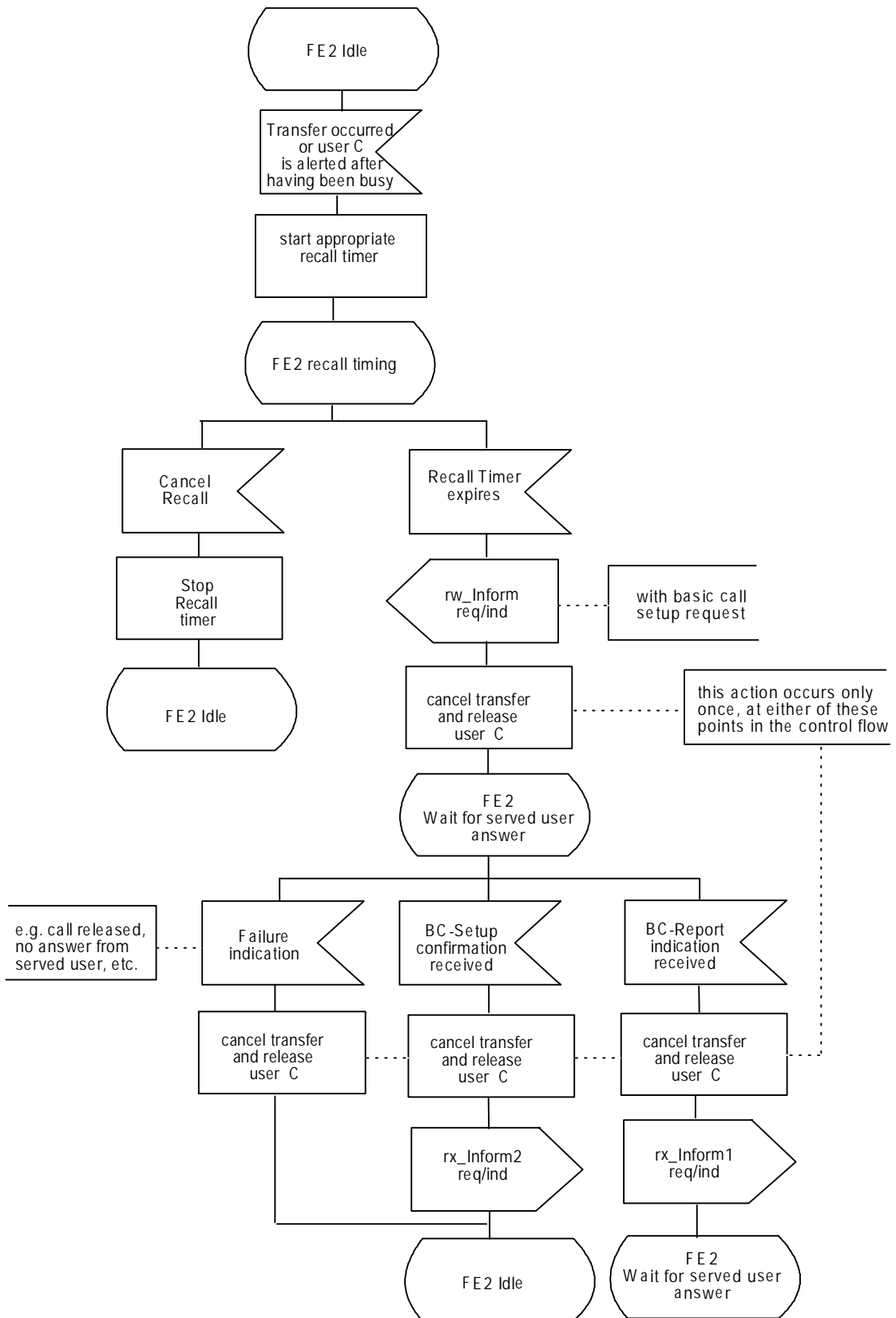

Figure 6 - SS-RE SDL for functional entity FE2

7.4.3 Behaviour of FE3

Figure 7 shows the behaviour of FE3. Input symbols from the left represent information flows from FE2. Output symbols to the right represent information flows to FE4.

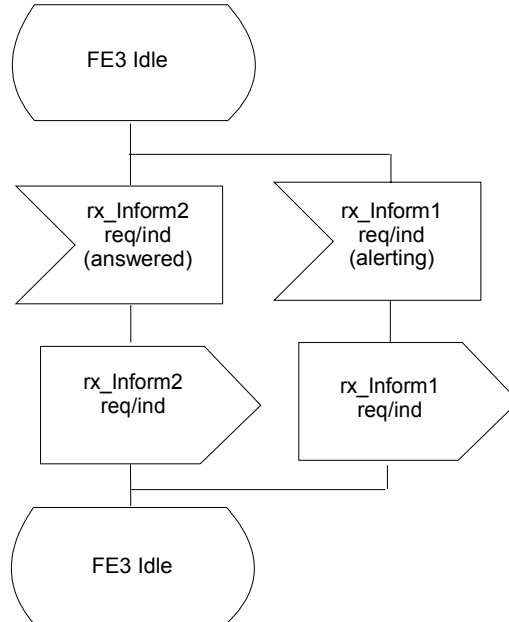

Figure 7 - SS-RE SDL for functional entity FE3

7.4.4 Behaviour of FE4

Figure 8 shows the behaviour of FE4. Input symbols from the left represent information flows from FE3. Output symbols to the right represent primitives to user B.

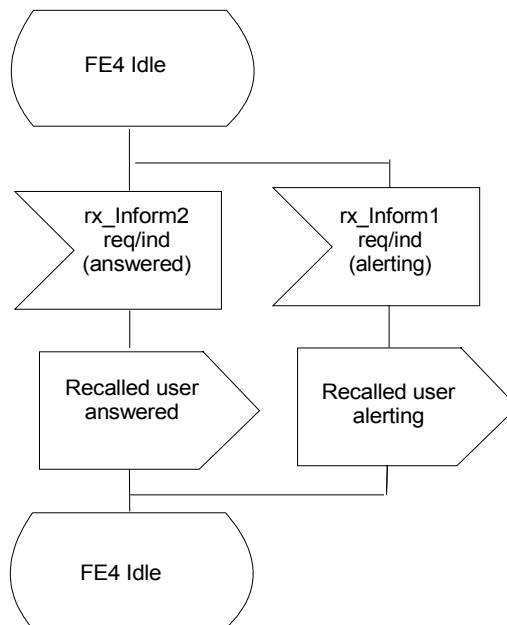

Figure 8 - SS-RE SDL for functional entity FE4

7.5 Allocation of functional entities to physical equipment

The allocations of FEs to physical equipment shown in table 5 shall apply. In the table, "TE" represents a TE attached to a PISN. Where a terminal is stimulus with respect to SS-RE, any FE shown as residing in the TE shall reside instead in that TE's local PINX.

Table 5 - Scenarios for the allocation of FEs to physical equipment

Scenarios	Functional entities			
	User A		User B	
	FE1	FE2	FE3	FE4
1	TE	PINX	PINX	TE
2	TE	PINX	Gateway PINX	other network
3	other network	other network	PINX	TE

Free printed copies can be ordered from:

ECMA

114 Rue du Rhône

CH-1204 Geneva

Switzerland

Fax: +41 22 849.60.01

Email: documents@ecma.ch

Files of this Standard can be freely downloaded from the ECMA web site (www.ecma.ch). This site gives full information on ECMA, ECMA activities, ECMA Standards and Technical Reports.

ECMA
114 Rue du Rhône
CH-1204 Geneva
Switzerland

See inside cover page for obtaining further soft or hard copies.