

ECMA

Standardizing Information and Communication Systems

---

---

---

**Private Integrated Services Network  
(PISN) -  
Cordless Terminal Mobility (CTM) -  
Inter-Exchange Signalling Protocol -  
Cordless Terminal Location  
Registration Supplementary Service**

---

---



ECMA

Standardizing Information and Communication Systems

---

---

---

**Private Integrated Services Network  
(PISN) -  
Cordless Terminal Mobility (CTM) -  
Inter-Exchange Signalling Protocol -  
Cordless Terminal Location  
Registration Supplementary Service**

---

---

**(QSIG-CTRL)**



## **Brief History**

This Standard is one of a series of ECMA Standards defining services and signalling protocols applicable to Private Integrated Services Networks (PISNs). The series uses ISDN concepts as developed by ITU-T and conforms to the framework of International Standards for Open Systems Interconnection as defined by ISO/IEC. It has been produced under ETSI work item DE/ECMA-00112.

This particular Standard specifies the signalling protocol for use at the Q reference point in support of the Cordless Terminal Location Registration supplementary service. The protocol defined in this Standard forms part of the PSS1 protocol (informally known as QSIG).

This Standard is based upon the practical experience of ECMA member companies and the results of their active and continuous participation in the work of ISO/IEC JTC1, ITU-T, ETSI and other international and national standardization bodies. It represents a pragmatic and widely based consensus.

Compared to the 1st Edition of Standard ECMA-216 (published by ECMA in December 1994), various changes have been made in order to achieve alignment with ETS 300 693 (which is based on the 1st Edition of ECMA-216 but modified during Public Enquiry).



## Table of contents

|   |          |
|---|----------|
| <b>1 Scope</b>  | <b>1</b> |
| <b>2 Conformance</b>  | <b>1</b> |
| <b>3 References (normative)</b>   | <b>1</b> |
| <b>4 Definitions</b>  | <b>2</b> |
| 4.1 External definitions  | 2        |
| <b>5 List of acronyms</b>   | <b>3</b> |
| <b>6 Signalling protocol for the support of SS-CTRL</b>                                 | <b>3</b> |
| 6.1 SS-CTRL description   | 3        |
| 6.2 SS-CTRL operational requirements  | 3        |
| 6.2.1 Requirements on the Visitor PINX  | 3        |
| 6.2.2 Requirements on the Home PINX   | 3        |
| 6.2.3 Requirements on a Transit PINX  | 3        |
| 6.2.4 Requirements on the Directory PINX  | 3        |
| 6.3 SS-CTRL coding requirements   | 4        |
| 6.3.1 Operations  | 4        |
| 6.3.2 Information elements  | 5        |
| 6.3.3 Messages  | 6        |
| 6.4 SS-CTRL state definitions   | 6        |
| 6.4.1 States at the Visitor PINX  | 6        |
| 6.4.2 States at the Home PINX   | 6        |
| 6.4.3 States at the Directory PINX  | 6        |
| 6.5 SS-CTRL signalling procedures for location registration                             | 6        |
| 6.5.1 Actions at the Visitor PINX for location registration                             | 6        |
| 6.5.2 Additional actions at the Visitor PINX for enquiry to the previous Visitor PINX   | 7        |
| 6.5.3 Additional actions at the Visitor PINX for enquiry to a Directory PINX            | 8        |
| 6.5.4 Actions at the Home PINX for location registration                                | 8        |
| 6.5.5 Actions at a Transit PINX for location registration                               | 9        |
| 6.5.6 Actions at the previous Visitor PINX for location registration                    | 9        |
| 6.5.7 Additional actions at the previous Visitor PINX for enquiry from the Visitor PINX | 10       |
| 6.5.8 Actions at the Directory PINX for enquiry from the Visitor PINX                   | 10       |
| 6.6 SS-CTRL signalling procedures for location deregistration                           | 10       |
| 6.6.1 Actions at the Visitor PINX for location deregistration                           | 10       |
| 6.6.2 Actions at the Home PINX for location deregistration                              | 11       |
| 6.6.3 Actions at a Transit PINX for location deregistration                             | 11       |
| 6.7 SS-CTRL impact of interworking with public ISDNs                                    | 11       |
| 6.8 SS-CTRL impact of interworking with non-ISDNs                                       | 11       |
| 6.9 Protocol interactions between SS-CTRL and other supplementary services and ANFs     | 11       |
| 6.9.1 Interaction with Calling Name Identification Presentation (SS-CNIP)               | 11       |

|  |           |
|--|-----------|
| 6.9.2 Interaction with Connected Name Identification Presentation (SS-CONP)                | 11        |
| 6.9.3 Interaction with Call Forwarding Unconditional (SS-CFU)                              | 11        |
| 6.9.4 Interaction with Call Forwarding Busy (SS-CFB)                                       | 12        |
| 6.9.5 Interaction with Call Forwarding No Reply (SS-CFNR)                                  | 12        |
| 6.9.6 Interaction with Path Replacement (ANF-PR)   | 12        |
| 6.9.7 Interaction with Call Transfer (SS-CT)   | 12        |
| 6.9.8 Interaction with Call Completion to Busy Subscriber (SS-CCBS)                        | 12        |
| 6.9.9 Interaction with Call Completion on No Reply (SS-CCNR)                               | 12        |
| 6.9.10 Interaction with Call Offer (SS-CO)   | 12        |
| 6.9.11 Interaction with Do Not Disturb (SS-DND)  | 12        |
| 6.9.12 Interaction with Do Not Disturb Override (SS-DNDO)                                  | 12        |
| 6.9.13 Interaction with Call Intrusion (SS-CI)   | 12        |
| 6.9.14 Interaction with Cordless Terminal Incoming Call (SS-CTMI)                          | 12        |
| 6.9.15 Interaction with Call Interception (ANF-CINT)                                       | 12        |
| 6.9.16 Interaction with Recall (SS-RE)   | 12        |
| 6.9.17 Interaction with Advice Of Charge (SS-AOC)  | 12        |
| 6.10 SS-CTLR parameter values (timers)   | 12        |
| 6.10.1 Timer T1  | 12        |
| 6.10.2 Timer T2  | 13        |
| 6.10.3 Timer T3  | 13        |
| 6.10.4 Timer T4  | 13        |
| <b>Annex A - Protocol Implementation Conformance Statement (PICS) proforma</b>             | <b>15</b> |
| <b>Annex B - Examples of Message Sequences</b>   | <b>21</b> |
| <b>Annex C - Specification and Description Language (SDL) Representation of Procedures</b> | <b>27</b> |
| <b>Annex D - Bibliography</b>  | <b>33</b> |
| <b>Annex E - Imported ASN.1 definitions</b>  | <b>35</b> |



## 1 Scope

This Standard specifies the signalling protocol for the support of the Cordless Terminal Location Registration supplementary service (SS-CTLR) at the Q reference point between Private Integrated Services Network Exchanges (PINXs) connected together within a Private Integrated Services Network (PISN).

SS-CTLR is a supplementary service which enables a CTM user to register at, or deregister from, the current location within the PISN. The ability to register at different locations in the PISN at different times enables the CTM user to maintain the provided services (including the ability to make and receive calls) at different access points. Deregistration is used to inform the PISN that the CTM user is temporarily unable to make use of the provided services (including the receipt of calls). Roaming outside the PISN is outside the scope of this edition of this Standard.

The Q reference point is defined in ISO/IEC 11579-1.

Service specifications are produced in three stages and according to the method specified in ETS 300 387. This Standard contains the stage 3 specification for the Q reference point and satisfies the requirements (concerning SS-CTLR) identified by the stage 1 and stage 2 specifications in ETS 300 691 and ETS 300 692.

The signalling protocol for SS-CTLR uses certain aspects of the generic procedures for the control of supplementary services specified in ECMA-165.

This Standard also specifies additional signalling protocol requirements for the support of interactions at the Q reference point between SS-CTLR and other supplementary services and ANFs.

### NOTE 1

*Additional interactions that have no impact on the signalling protocol at the Q reference point can be found in the relevant stage 1 specifications.*

This Standard is applicable to PINXs which can interconnect to form a PISN.

## 2 Conformance

In order to conform to this Standard, a PINX shall satisfy the requirements identified in the Protocol Implementation Conformance Statement (PICS) proforma in annex A.

Conformance to this Standard includes conforming to those clauses that specify protocol interactions between SS-CTLR and other supplementary services and ANFs for which signalling protocols at the Q reference point are supported in accordance with the stage 3 standards concerned.

## 3 References (normative)

The following standards contain provisions which, through reference in this text, constitute provisions of this Standard. All standards are subject to revision, and parties to agreements based on this Standard are encouraged to investigate the possibility of applying the most recent editions of the standards indicated below.

In the case of references to ECMA Standards that are aligned with ISO/IEC International Standards, the number of the appropriate ISO/IEC International Standard is given in brackets after the ECMA reference.

|          |  |
|----------|--|
| ECMA-142 | Private Integrated Services Network - Circuit-mode 64 kbit/s Bearer Services - Service Description, Functional Capabilities and Information Flows (International Standard ISO/IEC 11574)               |
| ECMA-143 | Private Integrated Services Network - Circuit-mode Bearer Services - Inter-Exchange Signalling Procedures and Protocol (International Standard ISO/IEC 11572)  |
| ECMA-165 | Private Integrated Services Network - Generic Functional Protocol for the Support of Supplementary Services - Inter-Exchange Signalling Procedures and Protocol (International Standard ISO/IEC 11582) |
| ECMA-174 | Private Integrated Services Network - Inter-Exchange Signalling Protocol - Call Diversion Supplementary Services (International Standard ISO/IEC 13873)  |

|                  |  |
|------------------|--|
| ISO/IEC 11571    | Information technology - Telecommunications and information exchange between systems - Numbering and sub-addressing in private integrated services networks                            |
| ISO/IEC 11579-1  | Information technology - Telecommunications and information exchange between systems - Private Integrated Services Network - Part 1: Reference configuration for PISN Exchanges (PINX) |
| ETS 300 387      | Private Telecommunication Network (PTN); Method for the specification of basic and supplementary services (1994)   |
| ETS 300 415      | Private Telecommunication Network (PTN); Terms and definitions (1995)  |
| ETS 300 692      | Private Integrated Services Network (PISN); Cordless Terminal Mobility (CTM); Location handling services; Functional capabilities and information flows (1995)                         |
| ITU-T Rec. I.112 | Vocabulary of terms for ISDNs (1993)   |
| ITU-T Rec. I.210 | Principles of telecommunication services supported by an ISDN and the means to describe them (1993)  |
| ITU-T Rec. Q.950 | Digital Subscriber Signalling System No. 1 (DSS 1) - Supplementary services protocols, structure and general principles (1993)   |
| ITU-T Rec. Z.100 | Specification and description language (1993)  |

## 4 Definitions

For the purposes of this Standard, the following definitions apply.

### 4.1 External definitions

This Standard uses the following terms defined in other documents:

|   |                    |
|---|--------------------|
| - Application Protocol Data Unit (APDU)               | (ECMA-165)         |
| - Basic Service                                       | (ITU-T Rec. I.210) |
| - Complete Number                                     | (ISO/IEC 11571)    |
| - Co-ordination Function                              | (ECMA-165)         |
| - CTM user  | (ETS 300 692)      |
| - Directory PINX                                      | (ETS 300 692)      |
| - End PINX  | (ECMA-165)         |
| - Gateway PINX  | (ECMA-143)         |
| - Home data base (HDB)                                | (ETS 300 415)      |
| - Home PINX   | (ETS 300 692)      |
| - Location Area                                       | (ETS 300 692)      |
| - Network Facility Extension (NFE)                    | (ECMA-165)         |
| - Originating PINX                                    | (ECMA-165)         |
| - Private Integrated Services Network (PISN)          | (ISO/IEC 11579-1)  |
| - Private Integrated Services Network Exchange (PINX) | (ISO/IEC 11579-1)  |
| - PISN Number   | (ISO/IEC 11571)    |
| - Signalling  | (ITU-T Rec. I.112) |
| - Supplementary Service                               | (ITU-T Rec. I.210) |
| - Supplementary Services Control Entity               | (ECMA-165)         |

- Terminating PINX (ECMA-165)
- Transit PINX (ECMA-165)
- User (ECMA-142)
- Visitor area (ETS 300 415)
- Visitor data base (VDB) (ETS 300 415)
- Visitor PINX (ETS 300 692)

## 5 List of acronyms

|         |   |
|---------|---|
| ANF     | Additional Network Feature                                    |
| APDU    | Application Protocol Data Unit                                |
| ASN.1   | Abstract Syntax Notation no. 1                                |
| CTM     | Cordless Terminal Mobility                                    |
| HDB     | Home Data Base  |
| ISDN    | Integrated Services Digital Network                           |
| NFE     | Network Facility Extension                                    |
| PICS    | Protocol Implementation Conformance Statement                 |
| PISN    | Private Integrated Services Network                           |
| PINX    | Private Integrated Services Network Exchange                  |
| SDL     | Specification and Description Language                        |
| SS-CTLR | Cordless Terminal Location Registration supplementary service |
| VDB     | Visitor Data Base   |

## 6 Signalling protocol for the support of SS-CTLR

### 6.1 SS-CTLR description

SS-CTLR is a supplementary service which makes the location of a CTM user known to the PISN. By updating location information in the PISN, incoming calls can be routed to a CTM user, and the CTM user can access the PISN services from the current location area. SS-CTLR also enables a CTM user to inform the PISN that the current location area is no longer to be used to make and receive calls.

### 6.2 SS-CTLR operational requirements

#### 6.2.1 Requirements on the Visitor PINX

Generic procedures for the call independent control (connection oriented) of supplementary services, as specified in ECMA-165 for an Originating and Terminating PINX, shall apply.

#### 6.2.2 Requirements on the Home PINX

Generic procedures for the call independent control (connection oriented) of supplementary services, as specified in ECMA-165 for a Terminating and an Originating PINX, shall apply.

#### 6.2.3 Requirements on a Transit PINX

Generic procedures for the call independent control (connection oriented) of supplementary services, as specified in ECMA-165 for a Transit PINX, shall apply.

#### 6.2.4 Requirements on the Directory PINX

Generic procedures for the call independent control (connection oriented) of supplementary services, as specified in ECMA-165 for a Terminating PINX, shall apply.

## 6.3 SS-CTLR coding requirements

### 6.3.1 Operations

The operations defined in Abstract Syntax Notation number 1 (ASN.1) in table 1 shall apply.

**Table 1 - Operations in Support of SS-CTLR**

|  |  |
|--|--|
| CTM-Location-Registration-Operations{ iso identified-organization icd-ecma (0012) standard (0)<br>qsig-location-registration (216) ctrl-operations (0) } |  |
| DEFINITIONS EXPLICIT TAGS ::=  |  |
| BEGIN  |  |
| IMPORTS  | OPERATION, ERROR FROM Remote-Operation-Notation<br>{ joint-iso-ccitt (2) remote-operations (4) notation (0) }  |
|  | Extension FROM Manufacturer-specific-service-extension-definition<br>{ iso (1) standard (0)<br>pss1-generic-procedures (11582) msi-definition (0) }  |
|  | notAvailable, invalidServedUserNumber, supplementaryServiceInteractionNotAllowed<br>FROM General-Error-List<br>{ ccitt (0) recommendation (0) q(17) 950 general-error-list (1) }   |
|  | PartyNumber FROM Addressing-Data-Elements<br>{ iso (1) standard (0) pss1-generic-procedures (11582) addressing-data-elements<br>(9) }  |
|  | BasicService FROM Call-Diversion-Operations<br>{ iso (1) standard (0) pss1-call-diversion (13873) call-diversion-operations (0) };<br>-- Note. The definition of BasicService is reproduced in annex E   |
| LocUpdate ::=  | OPERATION<br>-- Sent from the Visitor PINX to the Home PINX.<br>ARGUMENT    LocUpdArg<br>RESULT      DummyRes<br>ERRORS      { invalidServedUserNumber, notAuthorized, unspecified,<br>supplementaryServiceInteractionNotAllowed }                     |
| LocDelete ::=  | OPERATION<br>-- Sent from the Home PINX to the previous Visitor PINX.<br>ARGUMENT    LocDelArg<br>RESULT      DummyRes<br>ERRORS      { temporarilyUnavailable, unspecified,<br>supplementaryServiceInteractionNotAllowed }                            |
| LocDeReg ::=   | OPERATION<br>-- Sent from the Visitor PINX to the Home PINX.<br>ARGUMENT    LocDeRegArg<br>RESULT      DummyRes<br>ERRORS      { notAvailable, unspecified,<br>supplementaryServiceInteractionNotAllowed }   |
| PisnEnquiry ::=  | OPERATION<br>-- Sent from the Visitor PINX to the previous Visitor PINX or a Directory PINX.<br>ARGUMENT    PisnEnqArg<br>RESULT      PisnEnqRes<br>ERRORS      { invalidServedUserNumber, unspecified,<br>supplementaryServiceInteractionNotAllowed } |

**Table 1 - Operations in Support of SS-CTLR (concluded)**

|                        |  |   |
|------------------------|--|---|
| LocUpdArg ::=          | SEQUENCE                                   | { pisinNumber PartyNumber,<br>-- The PISN number of the CTM user,<br>-- always a Complete Number.<br>basicService BasicService,<br>visitPINX PartyNumber,<br>-- The PISN number of the Visitor PINX,<br>-- always a Complete Number.<br>argExtension LrExtension OPTIONAL } |
| DummyRes ::=           | CHOICE                                     | { null NULL,<br>extension [ 1 ] IMPLICIT Extension,<br>sequOfExtn [ 2 ] IMPLICIT SEQUENCE OF Extension }  |
| LocDelArg ::=          | SEQUENCE                                   | { pisinNumber PartyNumber,<br>-- The PISN number of the CTM user,<br>-- always a Complete Number.<br>basicService BasicService,<br>argExtension LrExtension OPTIONAL }  |
| LocDeRegArg ::=        | SEQUENCE                                   | { pisinNumber PartyNumber,<br>-- The PISN number of the CTM user,<br>-- always a Complete Number.<br>basicService BasicService,<br>argExtension LrExtension OPTIONAL }  |
| PisnEnqArg ::=         | SEQUENCE                                   | { alternativeld Alternativeld,<br>-- Can be a temporary identifier, e.g. Network Assigned<br>-- Identity structure, or a fixed handset identifier.<br>argExtension LrExtension OPTIONAL }   |
| PisnEnqRes ::=         | SEQUENCE                                   | { pisinNumber PartyNumber,<br>-- The PISN number of the CTM user,<br>-- always a Complete Number.<br>dummyRes DummyRes OPTIONAL }   |
| Alternativeld ::=      | OCTET STRING (SIZE(1..20))                 |   |
| LrExtension ::=        | CHOICE                                     | { none NULL,<br>extension [ 1 ] IMPLICIT Extension,<br>sequOfExtn [ 2 ] IMPLICIT SEQUENCE OF Extension }  |
| locUpdate              | LocUpdate                                  | ::= 50  |
| locDelete              | LocDelete                                  | ::= 51  |
| locDeReg               | LocDeReg                                   | ::= 52  |
| pisnEnquiry            | PisnEnquiry                                | ::= 53  |
| notAuthorized          | ERROR                                      | ::= 1007  |
| temporarilyUnavailable | ERROR                                      | ::= 1000  |
| unspecified            | Unspecified                                | ::= 1008  |
| Unspecified ::=        | ERROR                                      | PARAMETER Extension   |
| END                    | -- of CTM-Location-Registration-Operations |   |

### 6.3.2 Information elements

#### 6.3.2.1 Facility information element

The operations defined in 6.3.1 shall be coded in the Facility information element in accordance with ECMA-165.

When conveying the invoke APDU of operations defined in 6.3.1, the destinationEntity data element of the NFE shall contain value endPINX.

When conveying the invoke APDU of operations defined in 6.3.1, the Interpretation APDU shall either be omitted or be included with value rejectAnyUnrecognisedInvokePdu.

#### **6.3.2.2 Other information elements**

Any other information elements (e.g. Calling party number, Called party number) shall be coded in accordance with the rules of ECMA-165.

#### **6.3.3 Messages**

The Facility information element shall be conveyed in the messages as specified in clause 10 of ECMA-165.

### **6.4 SS-CTLR state definitions**

#### **6.4.1 States at the Visitor PINX**

The procedures for the Visitor PINX are written in terms of the following conceptual states existing within the SS-CTLR Supplementary Service Control entity in that PINX in association with a particular location handling request.

##### **6.4.1.1 State VisitIdle**

SS-CTLR is not operating.

##### **6.4.1.2 State VisitUpdate**

A locUpdate invoke APDU has been sent.

##### **6.4.1.3 State VisitEnquiry**

A pismEnquiry invoke APDU has been sent.

##### **6.4.1.4 State VisitDeReg**

A locDeReg invoke APDU has been sent.

#### **6.4.2 States at the Home PINX**

The procedures for the Home PINX are written in terms of the following conceptual states existing within the SS-CTLR Supplementary Service Control entity in that PINX in association with a particular location handling request.

##### **6.4.2.1 State HomeIdle**

Ready for receipt of a locUpdate or locDeReg APDU.

##### **6.4.2.2 State HomeDelete**

A locDelete invoke APDU has been sent.

#### **6.4.3 States at the Directory PINX**

The procedures for the Directory PINX are written in terms of the following conceptual states existing within the SS-CTLR Supplementary Service Control entity in that PINX in association with a particular location handling request.

##### **6.4.3.1 State DirectoryIdle**

Ready for receipt of a pismEnquiry APDU.

### **6.5 SS-CTLR signalling procedures for location registration**

Examples of message sequences are shown in annex B.

#### **6.5.1 Actions at the Visitor PINX for location registration**

The SDL representation of procedures at the Visitor PINX is shown in C.1 of annex C.

##### **6.5.1.1 Normal procedures**

On receipt of a valid location registration request from a CTM user that is not already registered in the Visitor area, and if the Visitor PINX possesses sufficient addressing information to make a location registration request to the Home PINX, the Visitor PINX shall send a locUpdate invoke APDU to the Home PINX using

the call reference of a call independent signalling connection. The call independent signalling connection shall be established (or used, if an appropriate connection is already available) in accordance with the procedures specified in 7.3 of ECMA-165. Within the argument of the invoke APDU, the PISN number of the CTM user shall be included in element pismNumber, the basic service for which the CTM user is to be registered shall be included in element basicService, and a PISN number identifying the Visitor PINX shall be included in element visitPINX. This PISN number shall be suitable for use in the Called party number information element of a call or call independent signalling connection that is to be routed to the Visitor PINX. The Visitor PINX shall enter state VisitUpdate and start timer T1.

**NOTE 2**

*Validation of the registration request can involve authentication of the CTM user.*

**NOTE 3**

*In the absence of sufficient addressing information, the Visitor PINX can, before sending a locUpdate invoke APDU, use the procedures of 6.5.2 to make an enquiry to the previous Visitor PINX or the procedures of 6.5.3 to make an enquiry to a Directory PINX in order to translate an identifier provided by the CTM user in the registration request into a PISN number.*

**NOTE 4**

*The number to be used in the Called party number information element when establishing the call independent signalling connection to the Home PINX is outside the scope of this Standard. It can, for example, be a PISN number provided by the CTM user in the location registration request or optionally the PISN number provided by the previous Visitor PINX or Directory PINX.*

On receipt of the locUpdate return result APDU, the Visitor PINX shall stop timer T1, update the information in the VDB for the requested basic service, revert to state VisitIdle and indicate acceptance to the CTM user.

The Visitor PINX is responsible for clearing the call independent signalling connection towards the Home PINX. This may occur on receipt of a return result APDU. Alternatively, the signalling connection may be retained for other applications, if appropriate.

**6.5.1.2 Exceptional procedures**

On receipt of a locUpdate return error or reject APDU from the Home PINX, the Visitor PINX shall stop timer T1, revert to state VisitIdle and indicate rejection to the CTM user.

If timer T1 expires (i.e. the locUpdate invoke APDU is not answered by the Home PINX), the Visitor PINX shall indicate rejection to the CTM user and enter state VisitIdle.

The Visitor PINX is responsible for clearing the call independent signalling connection towards the Home PINX. This may occur on receipt of a return error or reject APDU or on expiry of timer T1. Alternatively, the signalling connection may be retained for other applications, if appropriate.

**6.5.2 Additional actions at the Visitor PINX for enquiry to the previous Visitor PINX**

The SDL representation of procedures at the Visitor PINX is shown in C.1 of annex C.

**6.5.2.1 Normal procedures**

In order to make an enquiry to the previous Visitor PINX to translate an identifier provided by the CTM user in the location registration request into a PISN number, the Visitor PINX may send a pismEnquiry invoke APDU to the previous Visitor PINX using the call reference of a call independent signalling connection. The call independent signalling connection shall be established (or used, if an appropriate connection is already available) in accordance with the procedures specified in 7.3 of ECMA-165. Within the argument of the invoke APDU, element alternativeld shall contain the identifier provided by the CTM user. The Visitor PINX shall enter state VisitEnquiry and start timer T2.

**NOTE 5**

*The number to be used in the Called party number information element when establishing the call independent signalling connection to the previous Visitor PINX is outside the scope of this Standard. It can, for example, be derived from the identifier provided by the CTM user.*

On receipt of the pismEnquiry return result APDU, the Visitor PINX shall stop timer T2. The PISN number received in the pismEnquiry return result APDU can be used for location registration.

The Visitor PINX is responsible for clearing the call independent signalling connection towards the previous Visitor PINX. This may occur on receipt of a return result APDU. Alternatively, the signalling connection may be retained for other applications, if appropriate.

#### **6.5.2.2 Exceptional procedures**

On receipt of a pismEnquiry return error or reject APDU from the previous Visitor PINX, the Visitor PINX shall stop timer T2 and enter state VisitIdle. If timer T2 expires, the Visitor PINX shall enter state VisitIdle.

##### *NOTE 6*

*In any of these situations the Visitor PINX will be unable to proceed with location registration and should indicate rejection to the CTM user, unless there is another means available for obtaining the PISN number of the CTM user.*

The Visitor PINX is responsible for clearing the call independent signalling connection towards the previous Visitor PINX. This may occur on receipt of a return error or reject APDU or on expiry of timer T2. Alternatively, the signalling connection may be retained for other applications, if appropriate.

#### **6.5.3 Additional actions at the Visitor PINX for enquiry to a Directory PINX**

The SDL representation of procedures at the Visitor PINX is shown in C.1 of annex C.

##### **6.5.3.1 Normal procedures**

In order to make an enquiry to a Directory PINX to translate an identifier provided by the CTM user in the location registration request into a PISN number, the Visitor PINX may send a pismEnquiry invoke APDU to the Directory PINX using the call reference of a call independent signalling connection. The call independent signalling connection shall be established (or used, if an appropriate connection is already available) in accordance with the procedures specified in 7.3 of ECMA-165. Within the argument of the invoke APDU, element alternativeId shall contain the identifier provided by the CTM user. The Visitor PINX shall enter state VisitEnquiry and start timer T2.

##### *NOTE 7*

*The number to be used in the Called party number information element when establishing the call independent signalling connection to the Directory PINX is outside the scope of this Standard.*

On receipt of the pismEnquiry return result APDU, the Visitor PINX shall stop timer T2. The PISN number received in the pismEnquiry return result APDU can be used for location registration.

The Visitor PINX is responsible for clearing the call independent signalling connection towards the Directory PINX. This may occur on receipt of a return result APDU. Alternatively, the signalling connection may be retained for other applications, if appropriate.

##### **6.5.3.2 Exceptional procedures**

On receipt of a pismEnquiry return error or reject APDU from the Directory PINX, the Visitor PINX shall stop timer T2 and enter state VisitIdle. If timer T2 expires, the Visitor PINX shall enter state VisitIdle.

##### *NOTE 8*

*In any of these situations the Visitor PINX will be unable to proceed with location registration and should indicate rejection to the CTM user, unless there is another means available for obtaining the PISN number of the CTM user.*

The Visitor PINX is responsible for clearing the call independent signalling connection towards the Directory PINX. This may occur on receipt of a return error or reject APDU or on expiry of timer T2. Alternatively, the signalling connection may be retained for other applications, if appropriate.

#### **6.5.4 Actions at the Home PINX for location registration**

The SDL representation of procedures at the Home PINX is shown in C.2 of annex C.



#### **6.5.4.1 Normal procedures**

On receipt of a locUpdate invoke APDU using the call reference of a call independent signalling connection (as specified in 7.3 of ECMA-165), the Home PINX shall check the received basic service (element basicService), and the CTM user's PISN number (element pisinNumber), and verify that the CTM user may update the location information.

If the CTM user may update the location information, the Home PINX shall update the location information in the HDB using the Visitor PINX number received in element visitPINX and answer the locUpdate invoke APDU with a return result APDU. If the Visitor area for the basic service has changed (i.e. the PISN number of the Visitor PINX has changed), the Home PINX shall send a locDelete invoke APDU to the previous Visitor PINX using the call reference of a call independent signalling connection. The call independent signalling connection shall be established (or used, if an appropriate connection is already available) in accordance with the procedures specified in 7.3 of ECMA-165. Within the argument of the invoke APDU, the PISN number of the CTM user shall be included in element pisinNumber and the basic service for which the CTM user has registered shall be included in element basicService. The Home PINX shall enter state HomeDelete and start timer T4.

On receipt of the locDelete return result APDU, the Home PINX shall stop timer T4 and enter state HomeIdle.

The Home PINX is responsible for clearing the call independent signalling connection towards the previous Visitor PINX. This may occur on receipt of a return result APDU. Alternatively, the signalling connection may be retained for other applications, if appropriate.

#### **6.5.4.2 Exceptional procedures**

If the Visitor area for the basic service is unchanged, the Home PINX shall revert to state HomeIdle.

If the CTM user is not found in the HDB, the Home PINX shall answer the locUpdate invoke APDU with a return error APDU containing the error invalidServedUserNumber.

If the CTM user is not allowed to update the location information, the Home PINX shall answer the locUpdate invoke APDU with a return error APDU containing the error notAuthorized.

On receipt of a locDelete return error or reject APDU from the previous Visitor PINX, the Home PINX shall stop timer T4 and enter state HomeIdle.

If timer T4 expires (i.e. the locDelete invoke APDU is not answered by the previous Visitor PINX), the Home PINX shall enter state HomeIdle.

##### *NOTE 9*

*Expiry of timer T4 or receipt of a locDelete return error or reject APDU may invoke management actions to correct the VDB data in the previous Visitor PINX.*

#### **6.5.5 Actions at a Transit PINX for location registration**

No special actions are required in support of location registration.

#### **6.5.6 Actions at the previous Visitor PINX for location registration**

The SDL representation of procedures at the previous Visitor PINX is shown in C.3 of annex C.

##### **6.5.6.1 Normal procedures**

On receipt of a locDelete invoke APDU using the call reference of a call independent signalling connection (as specified in 7.3 of ECMA-165), the previous Visitor PINX shall check the received basic service (element basicService) and the CTM user's PISN number (element pisinNumber), delete the VDB entry for the CTM user, and answer the locDelete invoke APDU with a return result APDU.

##### **6.5.6.2 Exceptional procedures**

If the CTM user is not found in the VDB, the previous Visitor PINX shall answer the locDelete invoke APDU with a return result APDU.

If the VDB is temporarily unavailable, the previous Visitor PINX shall answer the locDelete invoke APDU with a return error APDU containing the error temporarilyUnavailable.

## **6.5.7 Additional actions at the previous Visitor PINX for enquiry from the Visitor PINX**

The SDL representation of procedures at the previous Visitor PINX is shown in C.3 of annex C.

### **6.5.7.1 Normal procedures**

On receipt of a `pisnEnquiry` invoke APDU using the call reference of a call independent signalling connection (as specified in 7.3 of ECMA-165), the previous Visitor PINX shall check if the VDB contains an entry for the CTM user. If there is an entry, the CTM user's PISN number shall be returned in a `pisnEnquiry` return result APDU.

### **6.5.7.2 Exceptional procedures**

If the CTM user is not found in the VDB, the previous Visitor PINX shall answer the `pisnEnquiry` invoke APDU with a return error APDU containing the error `invalidServedUserNumber`.

*NOTE 10*

*If a PINX that receives a `pisnEnquiry` invoke APDU is capable of behaving as a Visitor PINX and as a Directory PINX, it should respond with a return error APDU only if the CTM user is present in neither the VDB nor the directory.*

## **6.5.8 Actions at the Directory PINX for enquiry from the Visitor PINX**

The SDL representation of procedures at the Directory PINX is shown in C.4 of annex C.

### **6.5.8.1 Normal procedures**

On receipt of a `pisnEnquiry` invoke APDU using the call reference of a call independent signalling connection (as specified in 7.3 of ECMA-165), the Directory PINX shall attempt to translate the CTM user's identity received in the `pisnEnquiry` invoke APDU to a PISN number. The CTM user's PISN number shall be returned in a `pisnEnquiry` return result APDU.

### **6.5.8.2 Exceptional procedures**

If the Directory PINX is unable to translate the identity received in the `pisnEnquiry` invoke APDU, a `pisnEnquiry` return error APDU containing the error `invalidServedUserNumber` shall be returned.

*NOTE 11*

*If a PINX that receives a `pisnEnquiry` invoke APDU is capable of behaving as a Visitor PINX and as a Directory PINX, it should respond with a return error APDU only if the CTM user is present in neither the VDB nor the directory.*

## **6.6 SS-CTLR signalling procedures for location deregistration**

Examples of message sequences are shown in annex B.

### **6.6.1 Actions at the Visitor PINX for location deregistration**

The SDL representation of procedures at the Visitor PINX is shown in C.1 of annex C.

#### **6.6.1.1 Normal procedures**

When a Visitor PINX determines that a CTM user is deregistered or on receipt of a valid location deregistration request from a CTM user, the Visitor PINX shall send a `locDeReg` invoke APDU to the Home PINX using the call reference of a call independent signalling connection. The call independent signalling connection shall be established (or used, if an appropriate connection is already available) in accordance with the procedures specified in 7.3 of ECMA-165. Within the argument of the invoke APDU, the PISN number of the CTM user shall be included in element `pisnNumber` and the basic service for which the CTM user has deregistered shall be included in element `basicService`. The Visitor PINX shall enter state `VisitDeReg` and start timer T3.

*NOTE 12*

*Validation of the deregistration request can involve authentication of the CTM user.*

On receipt of the `locDeReg` return result APDU, the Visitor PINX shall stop timer T3, delete the information in the VDB for the requested CTM user and basic service, revert to state `VisitIdle` and, if applicable, indicate acceptance to the CTM user.

The Visitor PINX is responsible for clearing the call independent signalling connection towards the Home PINX. This may occur on receipt of a return result APDU. Alternatively, the signalling connection may be retained for other applications, if appropriate.

#### **6.6.1.2 Exceptional procedures**

On receipt of a locDeReg return error or reject APDU from the Home PINX, the Visitor PINX shall stop timer T3, revert to state VisitIdle and, if applicable, indicate rejection to the CTM user.

If timer T3 expires (i.e. the locDeReg invoke APDU is not answered by the Home PINX), the Visitor PINX shall enter state VisitIdle and, if applicable, indicate rejection to the CTM user.

The Visitor PINX is responsible for clearing the call independent signalling connection towards the Home PINX. This may occur on receipt of a return error or reject APDU or on expiry of timer T3. Alternatively, the signalling connection may be retained for other applications, if appropriate.

### **6.6.2 Actions at the Home PINX for location deregistration**

The SDL representation of procedures at the Home PINX is shown in C.2 of annex C.

#### **6.6.2.1 Normal procedures**

On receipt of a locDeReg invoke APDU using the call reference of a call independent signalling connection (as specified in 7.3 of ECMA-165), the Home PINX shall check the received basic service (element basicService) and the CTM user's PISN number (element pisinNumber) and verify that the CTM user may deregister.

If the CTM user may deregister, the Home PINX shall update the location information in the HDB and answer the locDeReg invoke APDU with a return result APDU.

#### **6.6.2.2 Exceptional procedures**

If the CTM user may not deregister, the Home PINX shall answer the locDeReg invoke APDU with a return error APDU containing the error notAvailable.

### **6.6.3 Actions at a Transit PINX for location deregistration**

No special actions are required in support of SS-CTLR.

## **6.7 SS-CTLR impact of interworking with public ISDNs**

Not applicable.

## **6.8 SS-CTLR impact of interworking with non-ISDNs**

Not applicable.

## **6.9 Protocol interactions between SS-CTLR and other supplementary services and ANFs**

This clause specifies protocol interactions with other supplementary services and ANFs for which stage 3 standards had been published at the time of publication of this Standard. For interactions with supplementary services and ANFs for which stage 3 standards are published subsequent to the publication of this Standard, see those other stage 3 standards.

### *NOTE 13*

*Simultaneous conveyance of APDUs for SS-CTLR and other supplementary services or ANFs in the same message, each in accordance with the requirements of its respective stage 3 standard, does not, on its own, constitute a protocol interaction.*

#### **6.9.1 Interaction with Calling Name Identification Presentation (SS-CNIP)**

No interaction.

#### **6.9.2 Interaction with Connected Name Identification Presentation (SS-CONP)**

No interaction.

#### **6.9.3 Interaction with Call Forwarding Unconditional (SS-CFU)**

No interaction.

**6.9.4 Interaction with Call Forwarding Busy (SS-CFB)**

No interaction.

**6.9.5 Interaction with Call Forwarding No Reply (SS-CFNR)**

No interaction.

**6.9.6 Interaction with Path Replacement (ANF-PR)**

No interaction.

**6.9.7 Interaction with Call Transfer (SS-CT)**

No interaction.

**6.9.8 Interaction with Call Completion to Busy Subscriber (SS-CCBS)**

No interaction.

*NOTE 14*

*SS-CCBS may need to be cancelled if the CTM user (as either the calling user or called user) changes location or deregisters.*

**6.9.9 Interaction with Call Completion on No Reply (SS-CCNR)**

No interaction.

*NOTE 15*

*SS-CCNR may need to be cancelled if the CTM user (as either the calling user or called user) changes location or deregisters.*

**6.9.10 Interaction with Call Offer (SS-CO)**

No interaction.

**6.9.11 Interaction with Do Not Disturb (SS-DND)**

No interaction.

**6.9.12 Interaction with Do Not Disturb Override (SS-DNDO)**

No interaction.

**6.9.13 Interaction with Call Intrusion (SS-CI)**

No interaction.

**6.9.14 Interaction with Cordless Terminal Incoming Call (SS-CTMI)**

No interaction.

**6.9.15 Interaction with Call Interception (ANF-CINT)**

No interaction.

**6.9.16 Interaction with Recall (SS-RE)**

No interaction.

**6.9.17 Interaction with Advice Of Charge (SS-AOC)**

No interaction.

**6.10 SS-CTLR parameter values (timers)**

The following timers apply:

**6.10.1 Timer T1**

Timer T1 operates at the Visitor PINX during state VisitUpdate. Its purpose is to protect against the absence of a response to the locUpdate invoke APDU.

Timer T1 shall have a value not less than 15 s.

**6.10.2 Timer T2**

Timer T2 operates at the Visitor PINX during state VisitEnquiry. Its purpose is to protect against the absence of a response to the pIsnEnquiry invoke APDU.

Timer T2 shall have a value not less than 15 s.

**6.10.3 Timer T3**

Timer T3 operates at the Visitor PINX during state VisitDeReg. Its purpose is to protect against the absence of a response to the locDeReg invoke APDU.

Timer T3 shall have a value not less than 15 s.

**6.10.4 Timer T4**

Timer T4 operates at the Home PINX during state HomeDelete. Its purpose is to protect against the absence of a response to the locDelete invoke APDU.

Timer T4 shall have a value not less than 15 s.



## Annex A

(normative)

### Protocol Implementation Conformance Statement (PICS) proforma

#### A.1 Introduction

The supplier of a protocol implementation which is claimed to conform to this Standard shall complete the following Protocol Implementation Conformance Statement (PICS) proforma.

A completed PICS proforma is the PICS for the implementation in question. The PICS is a statement of which capabilities and options of the protocol have been implemented. The PICS can have a number of uses, including use:

- by the protocol implementor, as a check list to reduce the risk of failure to conform to the Standard through oversight;
- by the supplier and acquirer, or potential acquirer, of the implementation, as a detailed indication of the capabilities of the implementation, stated relative to the common basis for understanding provided by the Standard's PICS proforma;
- by the user or potential user of the implementation, as a basis for initially checking the possibility of interworking with another implementation; while interworking can never be guaranteed, failure to interwork can often be predicted from incompatible PICSs;
- by a protocol tester, as the basis for selecting appropriate tests against which to assess the claim for conformance of the implementation.

#### A.2 Instructions for completing the PICS proforma

##### A.2.1 General structure of the PICS proforma

The PICS proforma is a fixed format questionnaire divided into sub-clauses each containing a group of individual items. Each item is identified by an item number, the name of the item (question to be answered), and the reference(s) to the clause(s) that specifies (specify) the item in the main body of this Standard.

The "Status" column indicates whether an item is applicable and if so whether support is mandatory or optional.

The following terms are used:

|          |   |
|----------|---|
| m        | mandatory (the capability is required for conformance to the protocol);   |
| o        | optional (the capability is not required for conformance to the protocol, but if the capability is implemented it is required to conform to the protocol specifications); |
| o.<n>    | optional, but support of at least one of the group of options labelled by the same numeral <n> is required;   |
| x        | prohibited;   |
| c.<cond> | conditional requirement, depending on support for the item or items listed in condition <cond>;   |
| <item>;m | simple conditional requirement, the capability being mandatory if item number <item> is supported, otherwise not applicable;  |
| <item>;o | simple conditional requirement, the capability being optional if item number <item> is supported, otherwise not applicable.   |

Answers to the questionnaire items are to be provided either in the "Support" column, by simply marking an answer to indicate a restricted choice (Yes or No), or in the "Not Applicable" column (N/A).

### **A.2.2 Additional information**

Items of Additional Information allow a supplier to provide further information intended to assist the interpretation of the PICS. It is not intended or expected that a large quantity will be supplied, and a PICS can be considered complete without any such information. Examples might be an outline of the ways in which a (single) implementation can be set up to operate in a variety of environments and configurations. References to items of Additional Information may be entered next to any answer in the questionnaire, and may be included in items of Exception information.

### **A.2.3 Exception information**

It may occasionally happen that a supplier will wish to answer an item with mandatory or prohibited status (after any conditions have been applied) in a way that conflicts with the indicated requirement. No pre-printed answer will be found in the “Support” column for this. Instead, the supplier is required to write into the “Support” column an x.<i> reference to an item of Exception Information, and to provide the appropriate rationale in the Exception item itself.

An implementation for which an Exception item is required in this way does not conform to this Standard. A possible reason for the situation described above is that a defect in the Standard has been reported, a correction for which is expected to change the requirement not met by the implementation.



### A.3 PICS proforma for ECMA-216

#### A.3.1 Implementation identification

|  |  |
|--|--|
| Supplier   |  |
| Contact point for queries about the PICS   |  |
| Implementation Name(s) and Version(s)  |  |
| Other information necessary for full identification, e.g. Name(s) and Version(s) for machines and/or operating systems; system name(s) |  |

Only the first three items are required for all implementations; other information may be completed as appropriate in meeting the requirement for full identification.

The terms Name and Version should be interpreted appropriately to correspond with a supplier's terminology (e.g. Type, Series, Model).

#### A.3.2 Protocol summary

|   |  |
|---|--|
| Protocol version                                    | 1.0  |
| Addenda implemented (if applicable)                 |  |
| Amendments implemented                              |  |
| Have any exception items been required (see A.2.3)? | No <input type="checkbox"/> Yes <input type="checkbox"/><br>(The answer Yes means that the implementation does not conform to this Standard) |

|                   |  |
|-------------------|--|
| Date of Statement |  |
|-------------------|--|

### A.3.3 General

| Item | Question/feature  | References | Status | N/A                      | Support  |
|------|---|------------|--------|--------------------------|--|
| A1   | Behaviour as Visitor PINX and previous Visitor PINX for SS-CTRL |            | o.1    |                          | Yes <input type="checkbox"/> No <input type="checkbox"/> |
| A2   | Behaviour as Home PINX for SS-CTRL                              |            | o.1    |                          | Yes <input type="checkbox"/> No <input type="checkbox"/> |
| A3   | Behaviour as Directory PINX for SS-CTRL                         |            | o.1    |                          | Yes <input type="checkbox"/> No <input type="checkbox"/> |
| A4   | Support as a Visitor PINX of enquiry to previous Visitor PINX   |            | A1:o   | <input type="checkbox"/> | Yes <input type="checkbox"/> No <input type="checkbox"/> |
| A5   | Support as a Visitor PINX of enquiry to Directory PINX          |            | A1:o   | <input type="checkbox"/> | Yes <input type="checkbox"/> No <input type="checkbox"/> |

### A.3.4 Procedures

| Item | Question/feature  | References              | Status | N/A                      | Support                         |
|------|---|-------------------------|--------|--------------------------|---------------------------------|
| B1   | Support of ECMA-165 procedures at a Visitor and previous Visitor PINX   | 6.2.1                   | A1:m   | <input type="checkbox"/> | m: Yes <input type="checkbox"/> |
| B2   | Support of ECMA-165 procedures at a Home PINX   | 6.2.2                   | A2:m   | <input type="checkbox"/> | m: Yes <input type="checkbox"/> |
| B3   | Support of ECMA-165 procedures at a Directory PINX  | 6.2.4                   | A3:m   | <input type="checkbox"/> | m: Yes <input type="checkbox"/> |
| B4   | Signalling procedures at a Visitor and previous Visitor PINX  | 6.5.1<br>6.5.6<br>6.6.1 | A1:m   | <input type="checkbox"/> | m: Yes <input type="checkbox"/> |
| B5   | Additional signalling procedures at a Visitor PINX and previous Visitor PINX for enquiry from Visitor PINX to the previous Visitor PINX | 6.5.2<br>6.5.7          | A4:m   | <input type="checkbox"/> | m: Yes <input type="checkbox"/> |
| B6   | Additional signalling procedures at a Visitor PINX for enquiry from Visitor PINX to a Directory PINX                                    | 6.5.3                   | A5:m   | <input type="checkbox"/> | m: Yes <input type="checkbox"/> |
| B7   | Signalling procedures at a Home PINX  | 6.5.4<br>6.6.2          | A2:m   | <input type="checkbox"/> | m: Yes <input type="checkbox"/> |
| B8   | Signalling procedures at a Directory PINX   | 6.5.8                   | A3:m   | <input type="checkbox"/> | m: Yes <input type="checkbox"/> |

### A.3.5 Coding

| Item | Question/feature  | References | Status | N/A | Support    |
|------|---|------------|--------|-----|------------|
| C1   | Sending of locUpdate invoke APDU and receipt of return result and return error APDUs    | 6.3        | A1:m   | [ ] | m: Yes [ ] |
| C2   | Sending of locDelete invoke APDU and receipt of return result and return error APDUs    | 6.3        | A2:m   | [ ] | m: Yes [ ] |
| C3   | Sending of locDeReg invoke APDU and receipt of return result and return error APDUs     | 6.3        | A1:m   | [ ] | m: Yes [ ] |
| C4   | Sending of pisinEnquiry invoke APDU and receipt of return result and return error APDUs | 6.3        | c.1    | [ ] | m: Yes [ ] |
| C5   | Receipt of locUpdate invoke APDU and sending of return result and return error APDUs    | 6.3        | A2:m   | [ ] | m: Yes [ ] |
| C6   | Receipt of locDelete invoke APDU and sending of return result and return error APDUs    | 6.3        | A1:m   | [ ] | m: Yes [ ] |
| C7   | Receipt of locDeReg invoke APDU and sending of return result and return error APDUs     | 6.3        | A2:m   | [ ] | m: Yes [ ] |
| C8   | Receipt of pisinEnquiry invoke APDU and sending of return result and return error APDUs | 6.3        | c.2    | [ ] | m: Yes [ ] |

c.1: if A4 or A5 then m else N/A

c.2: if A3 or A4 then m else N/A

### A.3.6 Timers

| Item | Question/feature    | References | Status | N/A | Support                         |
|------|---------------------|------------|--------|-----|---------------------------------|
| D1   | Support of Timer T1 | 6.10.1     | A1:m   | [ ] | m: Yes [ ]<br>Value [ . . . . ] |
| D2   | Support of Timer T2 | 6.10.2     | c.3    | [ ] | m: Yes [ ]<br>Value [ . . . . ] |
| D3   | Support of Timer T3 | 6.10.3     | A1:m   | [ ] | m: Yes [ ]<br>Value [ . . . . ] |
| D4   | Support of Timer T4 | 6.10.4     | A2:m   | [ ] | m: Yes [ ]<br>Value [ . . . . ] |

c.3: if A4 or A5 then m else N/A



## Annex B

(informative)

### Examples of Message Sequences

This annex describes some typical message flows for SS-CTLR. The following conventions are used in the figures of this annex.

1. The following notation is used:

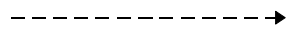
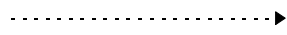
-  Call independent signalling connection message containing SS-CTLR information
-  Call independent signalling connection message without SS-CTLR information
-  Symbolic primitive carrying SS-CTLR information

|         |                                      |
|---------|--------------------------------------|
| xxx.inv | Invoke APDU for operation xxx        |
| xxx.res | Return result APDU for operation xxx |
| xxx.err | Return error APDU for operation xxx  |

2. The figures show messages exchanged via Protocol Control between PINXs involved in SS-CTLR. Only messages relevant to SS-CTLR are shown.
3. Only the relevant information content (e.g. remote operation APDUs, notifications, information elements) is listed below each message name. The Facility and Notification indicator information elements containing remote operation APDUs and notifications are not explicitly shown. Information with no impact on SS-CTLR is not shown.
4. Some interactions with users are included in the form of symbolic primitives. The actual protocol at the terminal interface is outside the scope of this Standard.

### B.1 Successful location registration

Figure B.1 shows an example message flow of successful location registration.

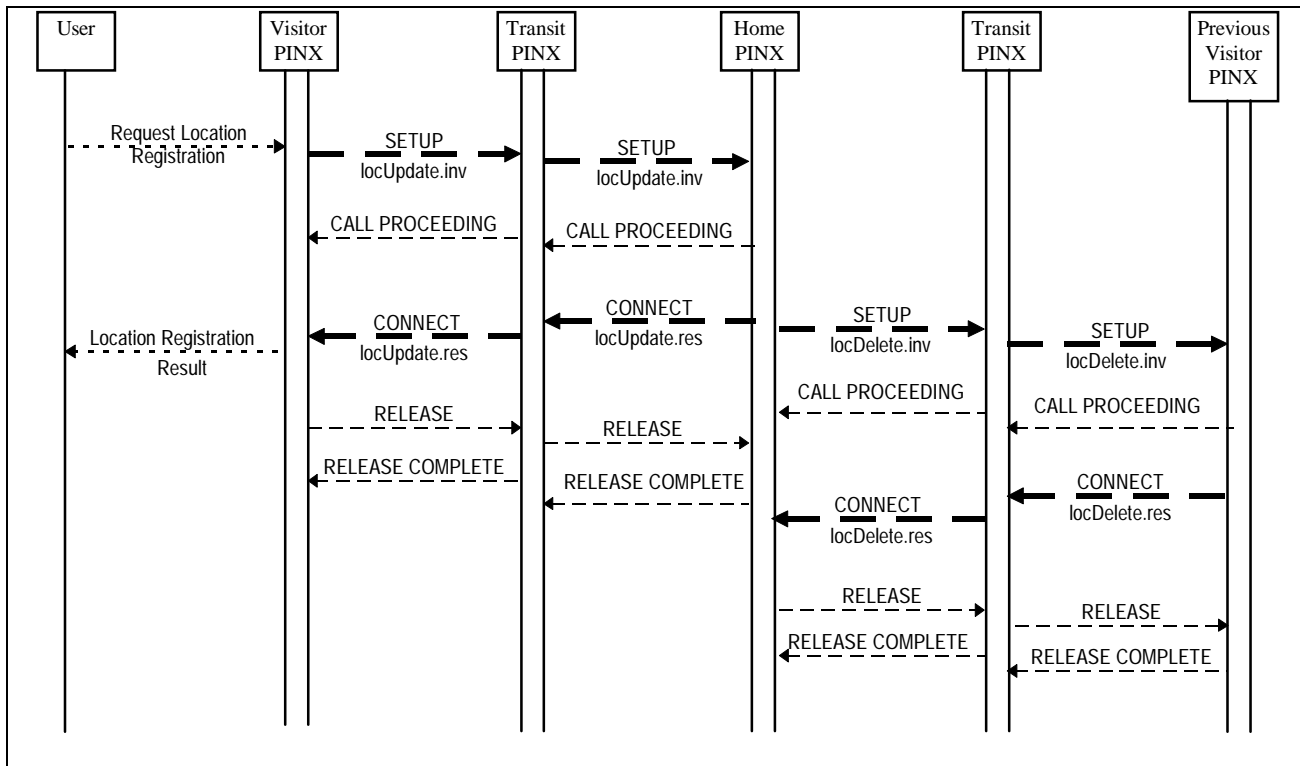

Figure B.1 - Example message flow for location registration

### B.1.1 Location registration with additional enquiry to the previous Visitor PINX

Figure B.2 shows an example message flow of successful location registration using the additional procedure with enquiry to the previous Visitor PINX to obtain the CTM user's PISN number.

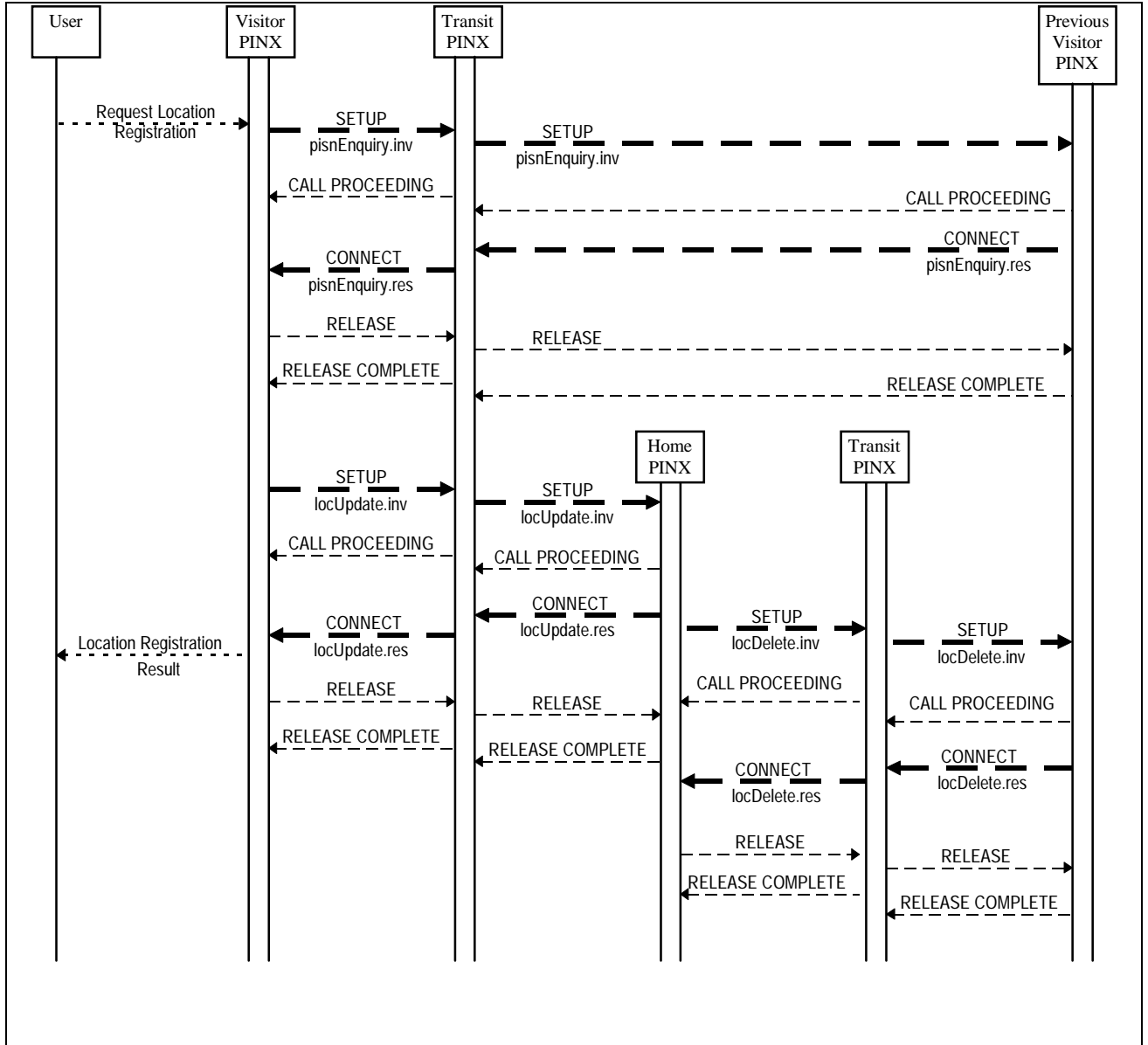

Figure B.2 - Example message flow for location registration with enquiry to the previous Visitor PINX

### B.1.2 Location registration with additional enquiry to a Directory PINX

Figure B.3 shows an example message flow of successful location registration using the additional procedure with enquiry to a Directory PINX to obtain the CTM user's PISN number.

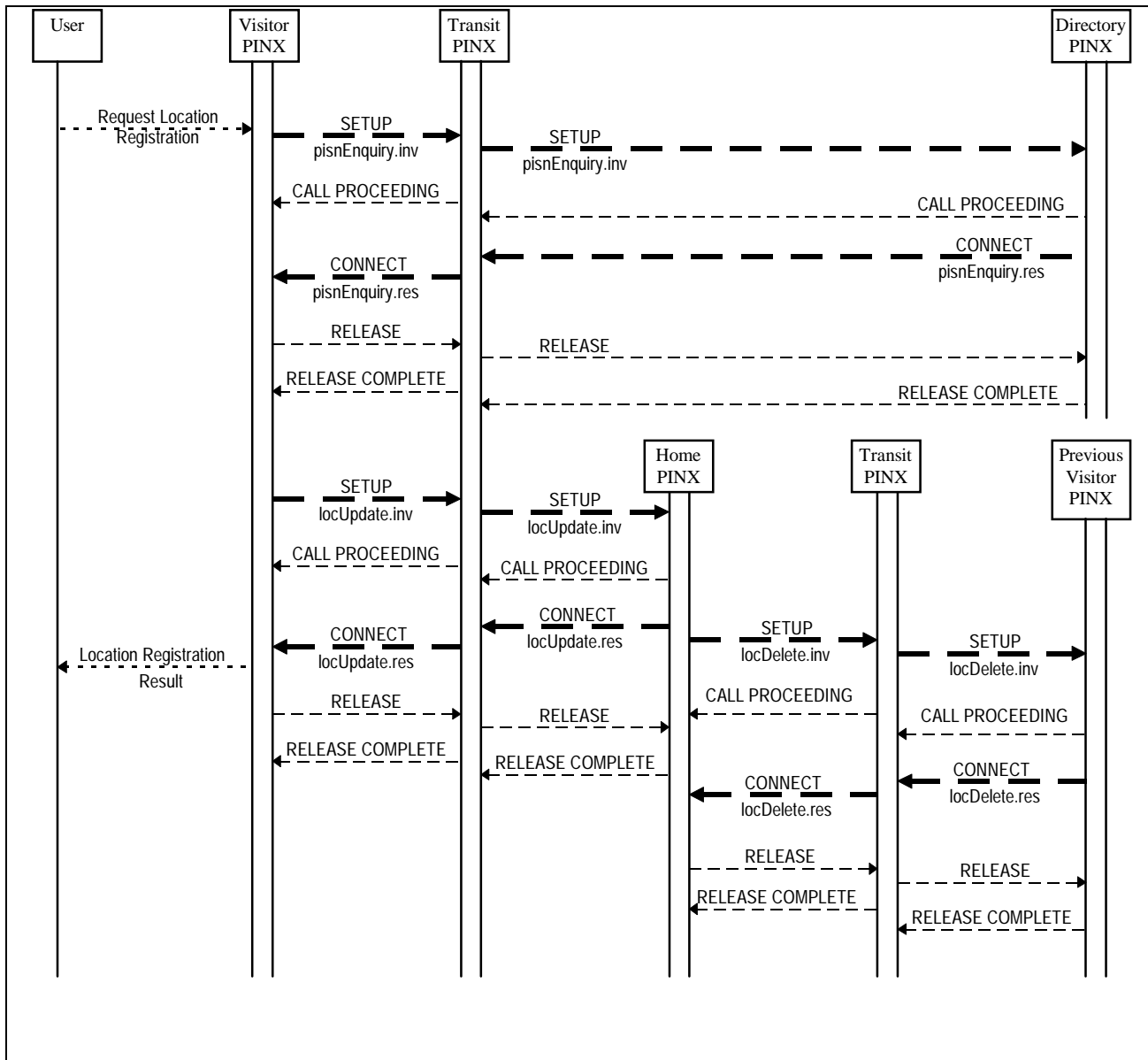

Figure B.3 - Example message flow for location registration with enquiry to a Directory PINX



## B.2 Successful location deregistration

Figure B.4 shows an example message flow of successful location deregistration.

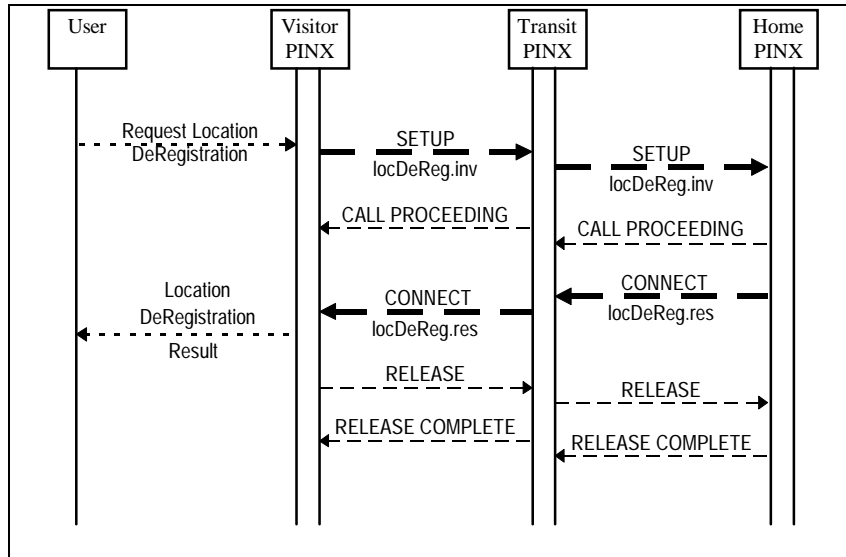

Figure B.4 - Example message flow for location deregistration



## **Annex C**

(informative)

### **Specification and Description Language (SDL) Representation of Procedures**

The diagrams in this annex use the Specification and Description Language defined in ITU-T Rec. Z.100 (1993).

Each diagram represents the behaviour of an SS-CTRL Supplementary Service Control entity at a particular type of PINX. In accordance with the protocol model described in ECMA-165, the Supplementary Service Control entity uses, via the Co-ordination Function, the services of Generic Functional Procedures Control.

Where an output symbol represents a primitive to the Co-ordination Function, and that primitive results in a message being sent, the output symbol bears the name of the message and any remote operation APDU(s) or notification(s) contained in that message.

Where an input symbol represents a primitive from the Co-ordination Function, and that primitive is the result of a message being received, the input symbol bears the name of the message and any remote operation APDU(s) or notification(s) contained in that message.

The following abbreviations are used:

- inv.     invoke APDU
- res.     return result APDU
- err.     return error APDU
- rej.     reject APDU

### C.1 SDL representation of SS-CTRL at the Visitor PINX

Figure C.1 shows the behaviour of an SS-CTRL Supplementary Service Control entity within the Visitor PINX.

Input signals from the left and output signals to the left represent primitives to and from the user.

Input signals from the right and output signals to the right represent primitives to and from the Co-ordination Function. Also protocol timer expiry is indicated by an input signal from the right.

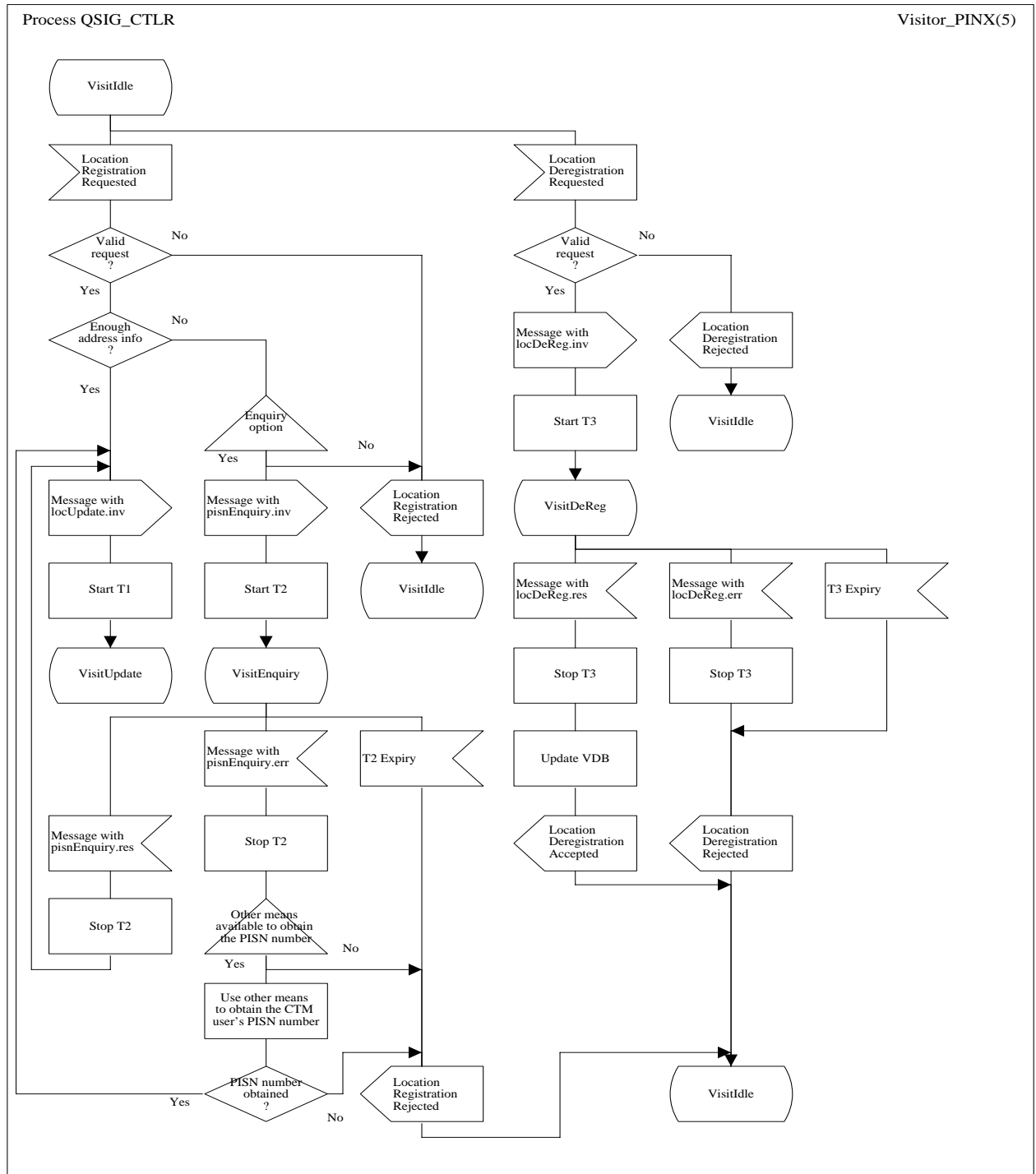

Figure C.1 - Visitor PINX behaviour (sheet 1 of 2)

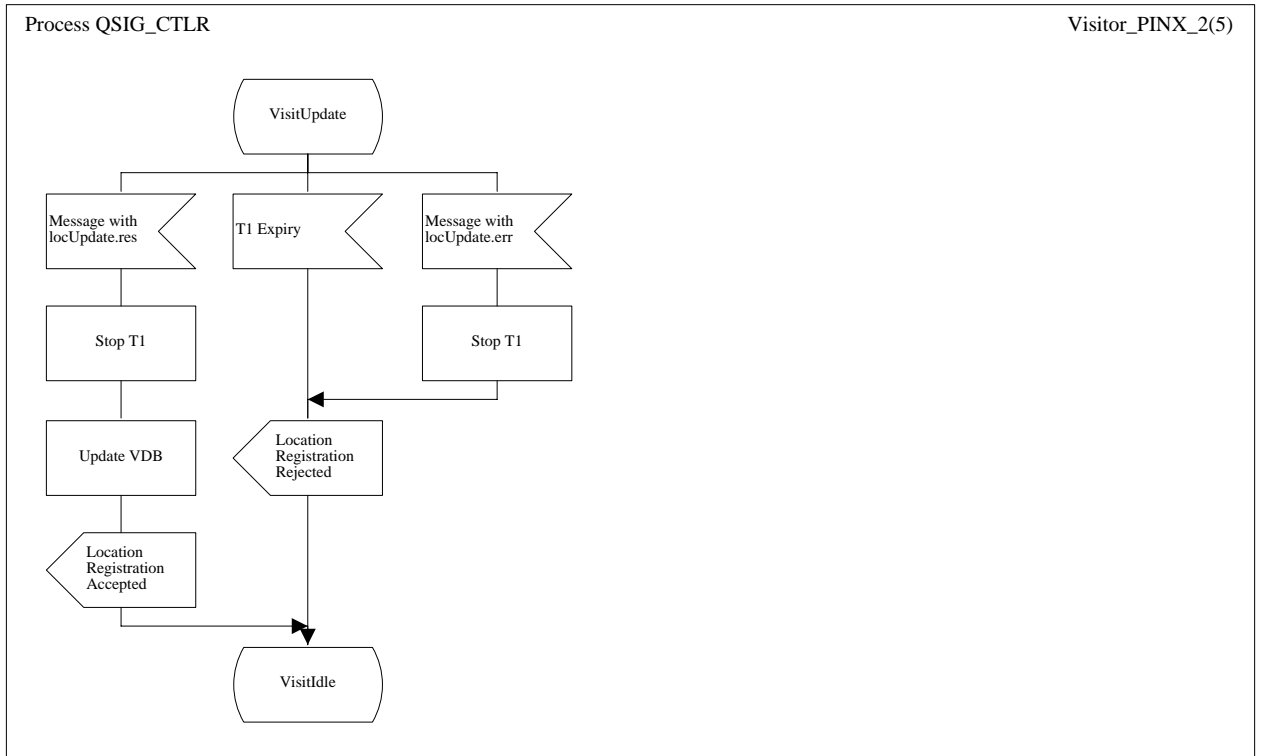

Figure C.1 - Visitor PINX behaviour (sheet 2 of 2)

## C.2 SDL representation of SS-CTRL at the Home PINX

Figure C.2 shows the behaviour of an SS-CTRL Supplementary Service Control entity within the Home PINX.

Input signals from the right and output signals to the right represent primitives to and from the Co-ordination Function. Also protocol timer expiry is indicated by an input signal from the right.

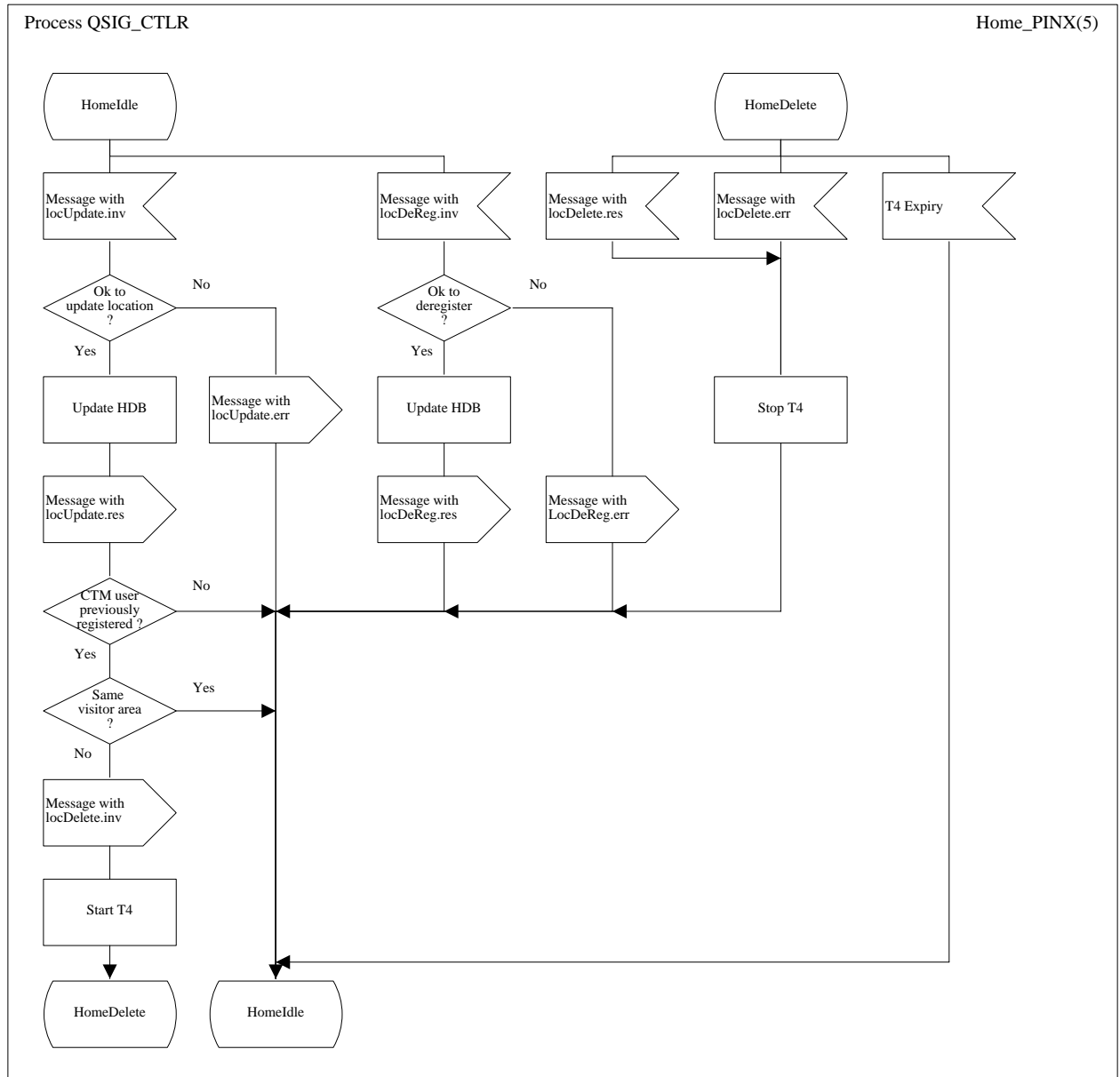

Figure C.2 - Home PINX behaviour

### C.3 SDL representation of SS-CTRL at the previous Visitor PINX

Figure C.3 shows the behaviour of an SS-CTRL Supplementary Service Control entity within the previous Visitor PINX.

Input signals from the right and output signals to the right represent primitives to and from the Co-ordination Function.

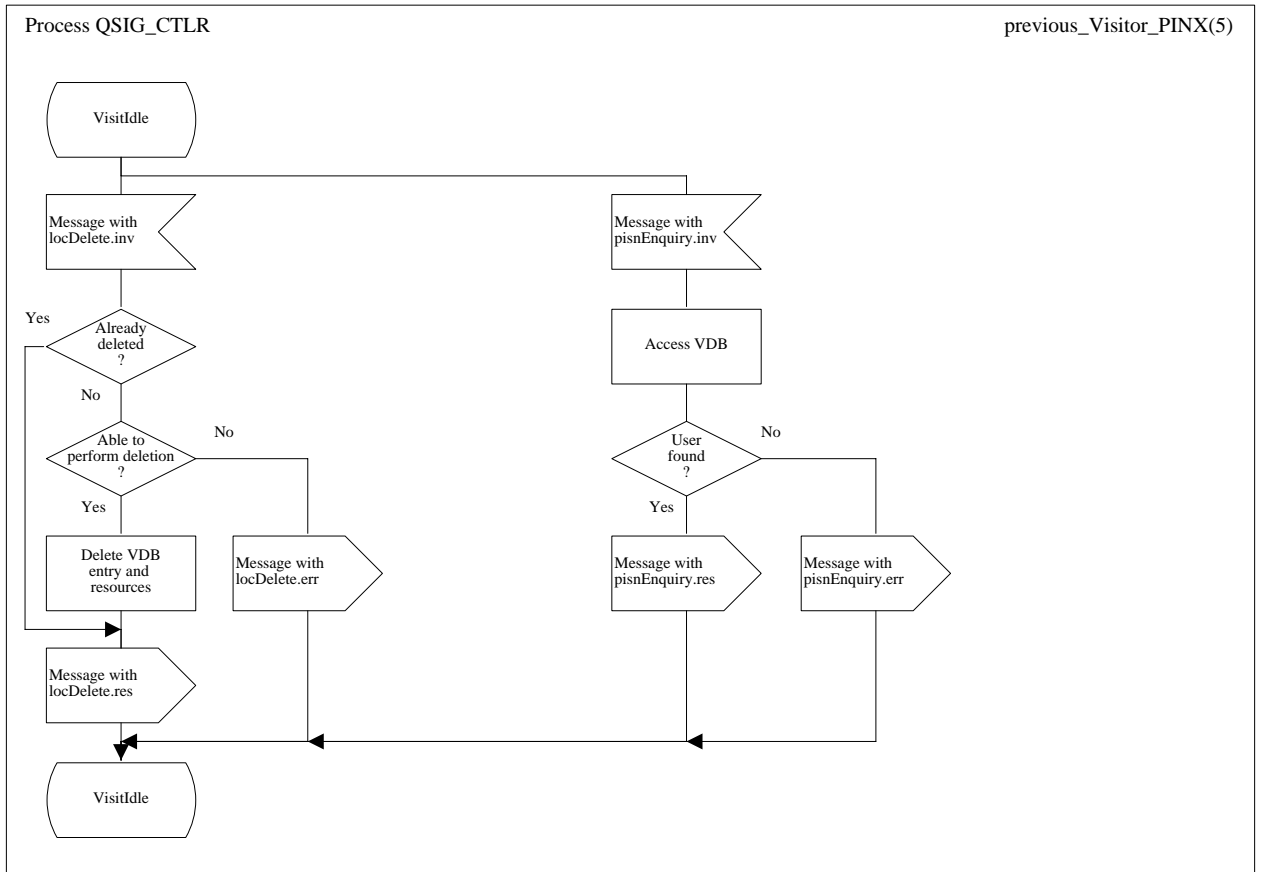

Figure C.3 - Previous Visitor PINX behaviour

### C.4 SDL representation of SS-CTRL at the Directory PINX

Figure C.4 shows the behaviour of an SS-CTRL Supplementary Service Control entity within the Directory PINX.

Input signals from the right and output signals to the right represent primitives to and from the Co-ordination Function.



Figure C.4 - Directory PINX behaviour



## **Annex D**

(informative)

## **Bibliography**

ETS 300 691      Private Integrated Services Network (PISN);  
Cordless Terminal Mobility (CTM);  
Location handling services;  
Service description (1996)



## Annex E

(informative)

### Imported ASN.1 definitions

Table E.1 is an extract from module General-Error-List in ITU-T recommendation Q.950.

**Table E.1 - Imported ASN.1 definitions General-Error-List**

|   |              |
|---|--------------|
| notAvailable  | ERROR ::= 3  |
| -- is an indication that the user has subscribed to this service but the requested service is not available combined with the basic service or the other services (e.g. operation). |              |
| InvalidServedUserNumber   | ERROR ::= 6  |
| -- is an indication that the requested service cannot be performed because of the usage of an invalid served user number.   |              |
| supplementaryServiceInteractionNotAllowed   | ERROR ::= 10 |
| -- is an indication that the Service request is not permitted in combination with either a further requested or active supplementary service.                                       |              |

Table E.2 is an extract from module Basic-Service-Elements in ISO/IEC 13873.

**Table E.2 - Imported ASN.1 definitions Basic-Service-Elements**

|                                     |     |            |
|-------------------------------------|-----|------------|
| BasicService                        | ::= | ENUMERATED |
| {allServices (0),                   |     |            |
| speech (1),                         |     |            |
| unrestrictedDigitalInformation (2), |     |            |
| audio3100Hz (3),                    |     |            |
| telephony (32),                     |     |            |
| teletex (33),                       |     |            |
| telefaxGroup4Class1 (34),           |     |            |
| videotexSyntaxBased (35),           |     |            |
| videotelephony (36)}                |     |            |

Table E.3 is an extract from module Addressing-Data-Elements in ISO/IEC 11582.

**Table E.3 - Imported ASN.1 definitions Addressing-Data-Elements**

|   |                                  |
|---|----------------------------------|
| PartyNumber   | ::= CHOICE {                     |
| unknownPartyNumber  | [0] IMPLICIT NumberDigits,       |
| -- the numbering plan is the default numbering plan of the network. |                                  |
| -- It is recommended that this value is used.                       |                                  |
| publicPartyNumber   | [1] IMPLICIT PublicPartyNumber,  |
| -- the numbering plan is according to Recs. E.163 and E.164.        |                                  |
| dataPartyNumber   | [3] IMPLICIT NumberDigits,       |
| -- not used, value reserved.  |                                  |
| telexPartyNumber  | [4] IMPLICIT NumberDigits,       |
| -- not used, value reserved.  |                                  |
| privatePartyNumber  | [5] IMPLICIT PrivatePartyNumber, |
| nationalStandardPartyNumber   | [8] IMPLICIT NumberDigits}       |
| -- not used, value reserved.  |                                  |
| PublicPartyNumber   | ::= SEQUENCE {                   |
| publicTypeOfNumber  | PublicTypeOfNumber,              |
| publicNumberDigits  | NumberDigits}                    |
| PrivatePartyNumber  | ::= SEQUENCE {                   |
| privateTypeOfNumber   | PrivateTypeOfNumber,             |
| privateNumberDigits   | NumberDigits}                    |
| NumberDigits  | ::= NumericString (SIZE(1..20))  |
| PublicTypeOfNumber  | ::= ENUMERATED {                 |
| unknown   | (0),                             |
| -- if used number digits carry prefix indicating type of number     |                                  |
| -- according to national recommendations                            |                                  |
| internationalNumber   | (1),                             |
| nationalNumber  | (2),                             |
| networkSpecificNumber   | (3),                             |
| -- not used, value reserved.  |                                  |
| subscriberNumber  | (4),                             |
| abbreviatedNumber   | (6)}                             |
| -- valid only for called party number at the outgoing access,       |                                  |
| -- network substitutes appropriate number                           |                                  |
| PrivateTypeOfNumber   | ::= ENUMERATED {                 |
| unknown   | (0),                             |
| level2RegionalNumber  | (1),                             |
| level1RegionalNumber  | (2),                             |
| pISNSpecificNumber  | (3),                             |
| localNumber   | (4),                             |
| abbreviatedNumber   | (6)}                             |





Printed copies can be ordered from:

**ECMA**

114 Rue du Rhône  
CH-1204 Geneva  
Switzerland

Fax: +41 22 849.60.01

Internet: [documents@ecma.ch](mailto:documents@ecma.ch)

Files can be downloaded from our FTP site, [ftp.ecma.ch](ftp://ftp.ecma.ch), logging in as **anonymous** and giving your E-mail address as **password**. This Standard is available from library **ECMA-ST** as a compacted, self-expanding file in MSWord 6.0 format (file E216-DOC.EXE) and as an Acrobat PDF file (file E216-PDF.PDF). File E216-EXP.TXT gives a short presentation of the Standard.

Our web site, <http://www.ecma.ch>, gives full information on ECMA, ECMA activities, ECMA Standards and Technical Reports.

**ECMA**

**114 Rue du Rhône  
CH-1204 Geneva  
Switzerland**

**This Standard ECMA-216 is available free of charge in printed form and as a file.**

**See inside cover page for instructions**