

ECMA

Standardizing Information and Communication Systems

**Private Integrated Services Network
(PISN) -
Inter-Exchange Signalling Protocol -
Private User Mobility (PUM) -
Call Handling Additional Network
Features**

ECMA

Standardizing Information and Communication Systems

**Private Integrated Services Network
(PISN) -
Inter-Exchange Signalling Protocol -
Private User Mobility (PUM) -
Call Handling Additional Network
Features**

(QSIG-PUMCH)

Brief History

This Standard is one of a series of standards defining services and signalling protocols applicable to Private Integrated Services Networks (PISNs). The series uses ISDN concepts as developed by ITU-T and conforms to the framework of standards for Open Systems Interconnection as defined by ISO/IEC.

This Standard specifies the signalling protocol for use at the Q reference point for Private User Mobility call handling additional network features ANF-PUMI and ANF-PUMO.

This Standard is based upon the practical experience of ECMA member companies and the results of their active and continuous participation in the work of ISO/IEC JTC1, ITU-T, ETSI and other international and national standardization bodies. It represents a pragmatic and widely based consensus.

Compared to the 1st Edition of Standard ECMA-284 (published by ECMA in December 1998), the 2nd Edition incorporates changes to achieve complete alignment with International Standard ISO/IEC 17878:2000(E) published by ISO/IEC in April 2000.

Compared to the 2nd edition of Standard ECMA-284 (published by ECMA in June 2000), this 3rd Edition incorporates migration to ASN.1 version 1997.

Adopted as 3rd Edition of Standard ECMA-284 by the General Assembly of December 2001.

Table of contents

1	Scope	1
2	Conformance	1
3	References (normative)	1
4	Definitions	3
4.1	External definitions	3
4.2	Alternative identifier	4
4.3	Home data base (HDB)	4
4.4	Rerouteing PINX	4
4.5	PUMI-detect PINX	4
4.6	Terminal equipment (TE)	4
4.7	Visitor data base (VDB)	4
5	List of acronyms	4
6	Signalling protocol for the support of ANF-PUMI	5
6.1	ANF-PUMI description	5
6.2	ANF-PUMI operational requirements	5
6.2.1	Requirements on the Rerouteing PINX	5
6.2.2	Requirements on the PUMI-detect PINX	5
6.2.3	Requirements on the Home PINX	5
6.2.4	Requirements on the Visitor PINX	5
6.2.5	Requirements on a Transit PINX	6
6.3	ANF-PUMI coding requirements	7
6.3.1	Operations	7
6.3.2	Information elements	9
6.3.3	Messages	10
6.4	ANF-PUMI state definitions	10
6.4.1	States at the Rerouteing PINX	10
6.4.2	States at the PUMI-detect PINX	10
6.4.3	States at the Home PINX	10
6.4.4	States at the Visitor PINX	10
6.5	ANF-PUMI signalling procedures for invocation and operation	10
6.5.1	Actions at the Rerouteing PINX	10
6.5.2	Actions at the PUMI-detect PINX	11
6.5.3	Actions at the Home PINX	13
6.5.4	Actions at the Visitor PINX	13
6.5.5	Actions at a Transit PINX	14
6.5.6	Actions at an Originating PINX	14
6.6	ANF-PUMI impact of interworking with public ISDNs	14
6.7	ANF-PUMI impact of interworking with non-ISDNs	14

6.8	Protocol interactions between ANF-PUMI and other supplementary services and ANFs	14
6.8.1	Interaction with Calling Name Identification Presentation (SS-CNIP)	14
6.8.2	Interaction with Connected Name Identification Presentation (SS-CONP)	14
6.8.3	Interaction with Call Completion to Busy Subscriber (SS-CCBS)	14
6.8.4	Interaction with Call Completion on No Reply (SS-CCNR)	15
6.8.5	Interaction with Call Transfer (SS-CT)	15
6.8.6	Interaction with Call Forwarding Unconditional (SS-CFU)	15
6.8.7	Interaction with Call Forwarding Busy (SS-CFB)	15
6.8.8	Interaction with Call Forwarding No Reply (SS-CFNR)	15
6.8.9	Interaction with Call Deflection (SS-CD)	15
6.8.10	Interaction with Path Replacement (ANF-PR)	15
6.8.11	Interaction with Call Offer (SS-CO)	15
6.8.12	Interaction with Call Intrusion (SS-CI)	15
6.8.13	Interaction with Do Not Disturb (SS-DND)	15
6.8.14	Interaction with Do Not Disturb Override (SS-DNDO)	15
6.8.15	Interaction with Advice Of Charge (SS-AOC)	16
6.8.16	Interaction with Recall (SS-RE)	16
6.8.17	Interaction with Call Interception (ANF-CINT)	16
6.8.18	Interaction with Transit Counter (ANF-TC)	16
6.8.19	Interaction with Route Restriction Class (ANF-RRC)	16
6.8.20	Interaction with Message Waiting Indication (SS-MWI)	17
6.8.21	Interaction with Wireless Terminal Location Registration (SS-WTLR)	17
6.8.22	Interaction with Wireless Terminal Incoming Call (ANF-WTMI)	17
6.8.23	Interaction with Wireless Terminal Outgoing Call (ANF-WTMO)	18
6.8.24	Interaction with Wireless Terminal Authentication of the Terminal (SS-WTAT)	18
6.8.25	Interaction with Wireless Terminal Authentication of the Network (SS-WTAN)	18
6.8.26	Interaction with Private User Mobility Registration (ANF-PUMR)	18
6.8.27	Interaction with Private User Mobility Outgoing Call (ANF-PUMO)	18
6.8.28	Interactions with Common Information (ANF-CMN)	18
6.8.29	Interaction with Call Priority Interruption (Protection) (SS-CPI(P))	18
6.9	ANF-PUMI parameter values (timers)	18
6.9.1	Timer T1	18
6.9.2	Timer T2	18
7	Signalling protocol for the support of ANF-PUMO	19
7.1	ANF-PUMO description	19
7.2	ANF-PUMO operational requirements	19
7.2.1	Requirements on the Originating PINX	19
7.2.2	Requirements on the Home PINX	19
7.2.3	Requirements on a Transit PINX	19
7.3	ANF-PUMO coding requirements	19
7.3.1	Operations	19
7.3.2	Information elements	19
7.3.3	Messages	19
7.4	ANF-PUMO State definitions	20
7.4.1	States at the Originating PINX	20

7.4.2	States at the Home PINX	20
7.5	ANF-PUMO signalling procedures	20
7.5.1	Actions at the Originating PINX	20
7.5.2	Actions at the Home PINX	20
7.5.3	Actions at the Transit PINX	21
7.6	ANF-PUMO impact of interworking with public ISDNs	21
7.7	ANF-PUMO impact of interworking with non-ISDNs	21
7.8	Protocol interactions between ANF-PUMO and other supplementary services and ANFs	21
7.8.1	Interaction with Calling Name Identification Presentation (SS-CNIP)	22
7.8.2	Interaction with Connected Name Identification Presentation (SS-CONP)	22
7.8.3	Interaction with Call Completion to Busy Subscriber (SS-CCBS)	22
7.8.4	Interaction with Call Completion on No Reply (SS-CCNR)	22
7.8.5	Interaction with Call Transfer (SS-WT)	22
7.8.6	Interaction with Call Diversion (SS-CFU, SS-CFB, SS-CFNR, SS-CD)	22
7.8.7	Interaction with Path Replacement (ANF-PR)	22
7.8.8	Interaction with Call Offer (SS-CO)	22
7.8.9	Interaction with Call Intrusion (SS-CI)	22
7.8.10	Interaction with Do Not Disturb (SS-DND)	22
7.8.11	Interaction with Do Not Disturb Override (SS-DNDO)	22
7.8.12	Interaction with Advice of Charge (SS-AOC)	22
7.8.13	Interaction with Recall (SS-RE)	22
7.8.14	Interaction with Call Interception (ANF-CINT)	22
7.8.15	Interaction with Transit Counter (ANF-TC)	22
7.8.16	Interaction with Route Restriction Class (ANF-RRC)	23
7.8.17	Interaction with Message Waiting Indication (SS-MWI)	23
7.8.18	Interaction with Wireless Terminal Location Registration (SS-WTLR)	23
7.8.19	Interaction with Wireless Terminal Incoming Call (ANF-WTMI)	23
7.8.20	Interaction with Wireless Terminal Outgoing Call (ANF-WTMO)	23
7.8.21	Interaction with Wireless Terminal Authentication of the Terminal (SS-WTAT)	23
7.8.22	Interaction with Wireless Terminal Authentication of the Network (SS-WTAN)	23
7.8.23	Interaction with Private User Mobility Registration (ANF-PUMR)	23
7.8.24	Interaction with Private User Mobility Incoming Call (ANF-PUMI)	23
7.8.25	Interaction with Common Information (ANF-CMN)	23
7.8.26	Interaction with Call Priority Interruption (Protection) (SS-CPI(P))	23
7.9	Parameter values (timers)	23
7.9.1	Timers at the Originating PINX	23
7.9.2	Timers at the Home PINX	23
Annex A - Protocol Implementation Conformance Statement (PICS) proforma		25
Annex B - Imported ASN.1 definitions		37
Annex C - Examples of Message Sequences		39
Annex D - Specification and Description Language (SDL) representation of procedures		45

Annex E - Additional feature identifier in module Common-Information-Operations	53
Annex F - ASN.1 definitions according to ITU-T Recs. X.208 / X.209	55

1 Scope

This Standard specifies the signalling protocol for the support of the Private User Mobility call handling additional network features (ANF-PUMI and ANF-PUMO) at the Q reference point between Private Integrated services Network eXchanges (PINX) connected together within a Private Integrated Services Network (PISN).

ANF-PUMI is a feature that directs incoming calls to a PUM user within the PISN regardless of the PUM user's geographical location within the PISN, provided that the PUM user's location is known.

ANF-PUMO permits the PISN to process call requests from a PUM user at the home location, if required.

The Q reference point is defined in ECMA-133.

Service specifications are produced in three stages and according to the method specified in ITU-T Rec. I.130. This Standard contains the stage 3 specification for the Q reference point and satisfies the requirements identified by the stage 1 and stage 2 specifications in ECMA-283.

The signalling protocol for ANF-PUMI and ANF-PUMO operates on top of the signalling protocol for basic circuit switched call control, as specified in ECMA-143, and uses certain aspects of the generic procedures for the control of supplementary services specified in ECMA-165.

This Standard also specifies additional signalling protocol requirements for the support of interactions at the Q reference point between ANF-PUMI / ANF-PUMO and other supplementary services and ANFs.

This Standard is applicable to PINXs which can interconnect to form a PISN.

2 Conformance

In order to conform to this Standard, a PINX shall satisfy the requirements identified in the Protocol Implementation Conformance Statement (PICS) proforma in annex A.

3 References (normative)

The following standards contain provisions which, through reference in this text, constitute provision of this Standard. All standards are subject to revision, and parties to agreements based on this Standard are encouraged to investigate the possibility of applying the most recent editions of the standards indicated below.

In the case of references to ECMA Standards that are aligned with ISO/IEC International Standards, the number of the appropriate ISO/IEC International Standard is given in brackets after the ECMA reference.

ECMA-133	Private Integrated Services Network (PISN) - Reference Configuration for PISN Exchanges (PINX) (International Standard ISO/IEC 11579-1)
ECMA-142	Private Integrated Services Network (PISN) - Circuit Mode 64kbit/s Bearer Services - Service Description, Functional Capabilities and Information Flows (International Standard ISO/IEC 11574)
ECMA-143	Private Integrated Services Network (PISN) - Circuit Mode Bearer Services - Inter-Exchange Signalling Procedures and Protocol (International Standard ISO/IEC 11572)
ECMA-155	Private Integrated Services Networks - Addressing (International Standard ISO/IEC 11571)
ECMA-164	Private Integrated Services Network (PISN) - Inter-Exchange Signalling Protocol - Name Identification Supplementary Services (International Standard ISO/IEC 13868)
ECMA-165	Private Integrated Services Network (PISN) - Generic Functional Protocol for the Support of Supplementary Services - Inter-Exchange Signalling Procedures and Protocol (International Standard ISO/IEC 11582)
ECMA-174	Private Integrated Services Network (PISN) - Inter-Exchange Signalling Protocol - Call Diversion Supplementary Services (International Standard ISO/IEC 13873)

ECMA-176	Private Integrated Services Network (PISN) - Inter-Exchange Signalling Protocol - Path Replacement Additional Network Feature (International Standard ISO/IEC 13874)
ECMA-192	Private Integrated Services Network (PISN) - Inter-Exchange Signalling Protocol - Call Offer Supplementary Service (International Standard ISO/IEC 14843)
ECMA-194	Private Integrated Services Network (PISN) - Inter-Exchange Signalling Protocol - Do Not Disturb and Do Not Disturb Override Supplementary Services (International Standard ISO/IEC 14844)
ECMA-203	Private Integrated Services Network (PISN) - Inter-Exchange Signalling Protocol - Call Intrusion Supplementary Service (International Standard ISO/IEC 14846)
ECMA-212	Private Integrated Services Network (PISN) - Inter-Exchange Signalling Protocol - Advice of Charge Supplementary Services (International Standard ISO/IEC 15050)
ECMA-221	Private integrated services network (PISN) - Inter-Exchange Signalling Protocol - Call Interception Additional Network Feature (International Standard ISO/IEC 15054)
ECMA-225	Private Integrated Services Network (PISN) - Inter-Exchange Signalling Protocol - Transit Counter Additional Network Feature (International Standard ISO/IEC 15056)
ECMA-242	Private Integrated Services Network (PISN) - Inter-Exchange Signalling Protocol - Message Waiting Indication Supplementary Service (International Standard ISO/IEC 15506)
ECMA-251	Private Integrated Services Network (PISN) - Inter-Exchange Signalling Protocol - Common Information Additional Network Feature (International Standard ISO/IEC 15772)
ECMA-264	Private Integrated Services Network (PISN) - Inter-Exchange Signalling Protocol - Call Priority Interruption and Call Priority Interruption Protection Supplementary Services (International Standard ISO/IEC 15992)
ECMA-281	Private Integrated Services Network (PISN) - Specification, Functional Model and Information Flows - Private User Mobility (PUM) - Registration Supplementary Service (International Standard ISO/IEC 17875)
ECMA-282	Private Integrated Services Network (PISN) - Inter-Exchange Signalling Protocol - Private User Mobility (PUM) - Registration Supplementary Service (International Standard ISO/IEC 17876)
ECMA-283	Private Integrated Services Network (PISN) - Specification, Functional Model and Information Flows - Private User Mobility (PUM) - Call Handling Additional Network Features (International Standard ISO/IEC 17877)
ECMA-304	Private Integrated Services Network (PISN) - Inter-Exchange Signalling Protocol - Wireless Terminal Call Handling Additional Network Features (International Standard ISO/IEC 15431)
ISO/IEC 13241	Information technology - Telecommunications and information exchange between systems - Private Integrated Services Network - Inter-exchange signalling protocol - Route restriction class additional network feature (1997)
ETS 300 415	Private Integrated Services Network (PISN); Terms and definitions (1996)
ITU-T Rec. I.112	Vocabulary of terms for ISDN (1993)
ITU-T Rec. I.130	Method for the characterization of telecommunication services supported by an ISDN and network capabilities of an ISDN (Blue Book) (1988)
ITU-T Rec. I.210	Principles of telecommunication services supported by an ISDN and the means to describe them (1993)
ITU-T Rec. Q.850	Usage of cause and location in the digital subscriber Signalling System No. 1 and the Signalling System No. 7 ISDN user part (1998)

- ITU-T Rec. Q.950 Supplementary services protocols, structure and general principles (2000)
ITU-T Rec. Z.100 Specification and description language (1999)

4 Definitions

For the purpose of this Standard the following definitions apply.

4.1 External definitions

This Standard uses the following terms defined in other documents:

- Additional Network Feature (ANF) (ECMA-165)
- AllCall registration (ECMA-281)
- Application Protocol Data Unit (APDU) (ECMA-165)
- Basic service (ITU-T Rec. I.210)
- Call, Basic call (ECMA-165)
- Call independent (ECMA-165)
- Call independent signalling connection (ECMA-165)
- Call related (ECMA-165)
- Complete number (ECMA-155)
- Co-ordination function (ECMA-165)
- End PINX (ECMA-165)
- InCall registration (ECMA-281)
- Incoming Gateway PINX (ECMA-143)
- Incoming PUM call (ECMA-283)
- Interpretation APDU (ECMA-165)
- Home PINX (ECMA-283)
- Hosting address (ECMA-283)
- Network Facility Extension (NFE) (ECMA-165)
- Originating PINX (ECMA-143)
- Private Integrated Services Network (PISN) (ECMA-133)
- Private Integrated services Network eXchange (PINX) (ECMA-133)
- PISN number (ECMA-155)
- Signalling (ITU-T Rec. I.112)
- Supplementary service (ITU-T Rec. I.210)
- Supplementary Service Control Entity (ECMA-165)
- Subsequent PINX (ECMA-143)
- Terminating PINX (ECMA-143)
- Transit PINX (ECMA-143)
- User (ECMA-142)
- PUM user (ECMA-283)
- Visitor PINX (ECMA-283)

4.2 **Alternative identifier**

An identifier, other than the PISN number, which identifies the PUM user uniquely.

4.3 **Home data base (HDB)**

The database in which the data on the current location and associated parameters of a wireless terminal or a mobile user are stored.

4.4 **Rerouteing PINX**

The PINX which executes the rerouteing of the incoming PUM call to the current Visitor PINX.

NOTE 1

In case of rerouteing, the Rerouteing PINX is either the Originating PINX or the Incoming Gateway PINX.

In case of forward switching, the Rerouteing PINX is the PUMI-detect PINX.

4.5 **PUMI-detect PINX**

The PINX which detects that an incoming call is to a PUM user.

NOTE 2

The PUMI-detect PINX is either the Home PINX, a Transit PINX, the Incoming Gateway PINX or the Originating PINX.

4.6 **Terminal equipment (TE)**

An item of equipment attached to a telecommunication network to provide access for a user to one or more services.

4.7 **Visitor data base (VDB)**

The database in which location information concerning a wireless terminal or a mobile user is stored, as long as the wireless terminal or the mobile user are localized in the corresponding visitor area.

5 **List of acronyms**

ANF	Additional Network Feature
ANF-CINT	Call Interception additional network feature
ANF-CMN	Common Information additional network feature
ANF-WTMI	Wireless Terminal Incoming call additional network feature
ANF-PR	Path Replacement additional network feature
(ANF-)PUMI	Private User Mobility Incoming Call (additional network feature)
(ANF-)PUMO	Private User Mobility Outgoing Call (additional network feature)
ANF-RRC	Route Restriction Class additional network feature
ANF-TC	Transit counter additional network feature
APDU	Application Protocol Data Unit
ASN.1	Abstract Syntax Notation no. 1
HDB	Home Data Base
ISDN	Integrated Services Digital Network
NFE	Network Facility Extension
PICS	Protocol Implementation Conformance Statement
PINX	Private Integrated services Network eXchange
PISN	Private Integrated Services Network
PUM	Private User Mobility
SDL	Specification and Description Language

SS-AOC	Advice Of Charge supplementary services
SS-CD	Call Deflection supplementary service
SS-CFB	Call Forwarding Busy supplementary service
SS-CFNR	Call Forwarding No Reply supplementary service
SS-CFU	Call Forwarding Unconditional supplementary service
SS-CI	Call Intrusion supplementary service
SS-CNIP	Calling Name Identification Presentation supplementary service
SS-CO	Call Offer supplementary service
SS-CPI(P)	Call Priority Interruption (Protection) supplementary service
SS-DNDO	Do Not Disturb Override supplementary service
SS-MWI	Message Waiting Indication supplementary service
TE	Terminal Equipment
VDB	Visitor Data Base

6 Signalling protocol for the support of ANF-PUMI

6.1 ANF-PUMI description

ANF-PUMI enables calls to be directed to a PUM user within the PISN. As there is no predetermined PINX for the connection of a PUM user to the PISN, the directing of such calls requires that information regarding the location of the user is available.

6.2 ANF-PUMI operational requirements

6.2.1 Requirements on the Rerouteing PINX

ECMA-143 protocol control procedures for call establishment at the outgoing side of an inter-PINX link shall apply to the establishment of the connection to the Visitor PINX. ECMA-143 protocol control procedures for call clearing shall apply to the release of the connection to the PUMI-detect PINX.

Generic procedures for the call related control of supplementary services, as specified in ECMA-165 for an End PINX, shall apply.

6.2.2 Requirements on the PUMI-detect PINX

ECMA-143 protocol control procedures for call establishment at the incoming side of an inter-PINX link shall apply to the establishment of the connection from the Originating or Incoming Gateway PINX. ECMA-143 protocol control procedures for call clearing shall apply to the release of the connection to the Rerouteing PINX.

Generic procedures for the call related control of supplementary services, as specified in ECMA-165 for an End PINX, shall apply.

Generic procedures for the call independent control (connection oriented) of supplementary services, as specified in ECMA-165 for an Originating PINX, shall apply.

6.2.3 Requirements on the Home PINX

Generic procedures for the call independent control (connection oriented) of supplementary services, as specified in ECMA-165 for a Terminating PINX, shall apply.

6.2.4 Requirements on the Visitor PINX

ECMA-143 protocol control procedures for call establishment at the incoming side of an inter-PINX link shall apply to the establishment of the connection from the Rerouteing PINX.

Generic procedures for the call related control of supplementary services, as specified in ECMA-165 for an End PINX, shall apply.

6.2.5 Requirements on a Transit PINX

Basic call procedures for call establishment and call clearing at a Transit PINX, as specified in ECMA-143, shall apply.

Generic procedures for the call related control and call independent control (connection oriented) of supplementary services, as specified in ECMA-165 for a Transit PINX, shall apply.

6.3 ANF-PUMI coding requirements

6.3.1 Operations

The operations defined in Abstract Syntax Notation number 1 (ASN.1) in table 1 shall apply. The notation is in accordance with ITU-T Rec. X.680 and X.690. The ITU-T Rec. X.208 and X.209 superseded version is in annex F.

Table 1 - Operations in support of call handling additional network features

Private-User-Mobility-Call-Handling-Operations-asn1-97	
{ iso (1) standard (0) pss1-pum-call-handling (17878) pum-call-handling-operations-asn1-97 (1)}	
DEFINITIONS EXPLICIT TAGS ::=	
BEGIN	
IMPORTS	OPERATION, ERROR FROM Remote-Operations-Information-Objects { joint-iso-itu-t remote-operations (4) informationObjects (5) version1 (0) }
	EXTENSION, Extension{} FROM Manufacturer-specific-service-extension-class-asn1-97 { iso (1) standard (0) pss1-generic-procedures (11582) msi-class-asn1-97(11) }
	PSS1InformationElement FROM PSS1-Generic-parameters-definition-asn1-97 { iso (1) standard (0) pss1-generic-procedures (11582) pss1-generic-parameters-asn1-97 (17) }
	Name FROM Name-Operations-asn1-97 { iso (1) standard (0) pss1-name (13868) name-operations-asn1-97 (1) }
	basicServiceNotProvided, invalidServedUserNr, notAvailable FROM General-Error-List { ccitt recommendation q 950 general-error-list (1) }
	Address, PartyNumber, PartySubaddress, PresentedNumberScreened FROM Addressing-Data-Elements-asn1-97 { iso (1) standard (0) pss1-generic-procedures (11582) addressing-data-elements-asn1-97 (20) };
Private-User-Mobility-Call-Handling--Operations OPERATION ::= { pumiEnquiry pumiDivert pumiInform pumoCall }	
<i>-- Operations for ANF-PUMI: --</i>	
pumiEnquiry	OPERATION ::= { <i>-- Sent from the PUMI-detect PINX to the Home PINX.</i> ARGUMENT EnquiryArg RESULT EnquiryRes ERRORS { invalidServedUserNr locationNotKnown notAvailable basicServiceNotProvided unspecified } CODE local: 93}
pumiDivert	OPERATION ::= { <i>-- Sent from the PUMI-detect PINX to the Rerouteing PINX.</i> ARGUMENT DivertArg RESULT DummyRes ERRORS { notAvailable unspecified } CODE local: 94}

Table 1 - Operations in support of call handling additional network features (continued)

pumiInform	OPERATION ::= { -- Sent from the Rerouting PINX to the Visitor PINX. ARGUMENT InformArg RETURN RESULT FALSE ALWAYS RESPONDS FALSE CODE local: 95}
EnquiryArg ::=	SEQUENCE { pisinNumber PartyNumber, -- The PISN number of the PUM user qSIGInfoElement PSS1InformationElement, -- The basic call information elements Bearer capability, High layer compatibility, -- Low layer compatibility can be embedded in the qSIGInfoElement -- in accordance with clause 6.5.2.1. argExtension PumiExtension OPTIONAL }
DivertArg ::=	SEQUENCE { hostingAddr PartyNumber, -- The PISN number of the hosting user, -- always a Complete Number. callingNumber PresentedNumberScreened, pumiIdentity PumiIdentity, -- The PISN number (always a Complete Number) -- and/or an alternative identifier of the PUM user. qSIGInfoElement PSS1InformationElement, -- The basic call information elements Bearer capability, High layer compatibility, -- Low layer compatibility, and Progress indicator -- can be embedded in the qSIGInfoElement in accordance with clause 6.5.2.1. callingUserSub [1] PartySubaddress OPTIONAL, callingUserName [2] Name OPTIONAL, pumiUserSub [3] PartySubaddress OPTIONAL, argExtension PumiExtension OPTIONAL }
InformArg ::=	SEQUENCE { pumiIdentity PumiIdentity, -- The PISN number (always a Complete Number) -- and/or an alternative identifier of the PUM user. argExtension PumiExtension OPTIONAL }
EnquiryRes ::=	CHOICE { currLocation [1] IMPLICIT CurrLocation, cfuActivated [2] IMPLICIT CfuActivated }
CurrLocation ::=	SEQUENCE { hostingAddr PartyNumber, -- The PISN number of the hosting user, -- always a Complete Number. pumiIdentity PumiIdentity, -- The PISN number (always a Complete Number) -- and/or an alternative identifier of the PUM user. argExtension PumiExtension OPTIONAL }
CfuActivated ::=	SEQUENCE { divToAddress Address, divOptions SubscriptionOption, pumiName [1] Name OPTIONAL, argExtension PumiExtension OPTIONAL }
SubscriptionOption ::=	ENUMERATED { noNotification (0), notificationWithoutDivertedToNr (1), notificationWithDivertedToNr (2) }

Table 1 - Operations in support of call handling additional network features (concluded)

DummyRes ::=	CHOICE	{ null extension sequOfExtn	NULL, [1] IMPLICIT Extension{{PUMCHExtSet}}, [2] IMPLICIT SEQUENCE OF Extension{{PUMCHExtSet}} }
PumiExtension ::=	CHOICE	{ extension sequOfExtn	[4] IMPLICIT Extension{{PUMCHExtSet}}, [5] IMPLICIT SEQUENCE OF Extension{{PUMCHExtSet}} }
PumIdentity ::=	CHOICE	{ pisinNumber alternativeld both	PartyNumber, [10] IMPLICIT Alternativeld, [11] IMPLICIT SEQUENCE { pisinNumber PartyNumber, alternativeld Alternativeld }
Alternativeld ::=	OCTET STRING(SIZE(1..20))		
-- Operation for ANF-PUMO --			
pumoCall	OPERATION ::= { ARGUMENT ALWAYS RESPONDS RETURN RESULT CODE	PumoArg FALSE FALSE local: 96}	
PumoArg ::=	SEQUENCE	{ destinationNumber pumidentity -- The PISN number (always a Complete Number) -- and/or an alternative identifier of the PUM user. sendingComplete extension {single multiple	[0] PartyNumber OPTIONAL, [1] PumIdentity OPTIONAL, [2] IMPLICIT NULL OPTIONAL, CHOICE [3] IMPLICIT Extension{{PUMCHExtSet}}, [4] IMPLICIT SEQUENCE OF Extension{{PUMCHExtSet}} } OPTIONAL }
PUMCHExtSet EXTENSION ::=	{...}		
locationNotKnown	ERROR	::= {	CODE local: 1015}
unspecified	ERROR	::= {	PARAMETER Extension{{PUMCHExtSet}} CODE local: 1008}
END	-- of Private-User-Mobility-Call-Handling-Operations-asn1-97		

6.3.2 Information elements

6.3.2.1 Facility information element

The operations defined in 6.3.1 shall be coded in the Facility information element in accordance with ECMA-165.

When conveying the invoke APDU of operations defined in 6.3.1 the destinationEntity data element of the NFE shall contain value endPINX.

When conveying the invoke APDU of operations defined in 6.3.1, the Interpretation APDU shall either be omitted or be included with value rejectAnyUnrecognisedInvokePdu.

6.3.2.2 Other information elements

Any other information elements (e.g. Calling party number, Called party number) shall be coded in accordance with the rules of ECMA-143 and ECMA-165.

6.3.3 Messages

The Facility information element shall be conveyed in the messages as specified in clause 10 of ECMA-165.

Messages used for call establishment shall be as specified in ECMA-143.

6.4 ANF-PUMI state definitions

6.4.1 States at the Rerouteing PINX

The procedures for the Rerouteing PINX are written in terms of the following conceptual states existing within the ANF-PUMI Supplementary Service Control entity in that PINX in association with a particular call.

6.4.1.1 State ExecIdle

Ready for receipt of a pumiDivert APDU.

6.4.2 States at the PUMI-detect PINX

The procedures for the PUMI-detect PINX are written in terms of the following conceptual states existing within the ANF-PUMI Supplementary Service Control entity in that PINX in association with a particular call.

6.4.2.1 State PUMI-Idle

ANF-PUMI is not operating.

6.4.2.2 State PUMI-Detected

A call to a PUM user has been detected and a pumiEnquiry invoke APDU requesting the current location of the PUM user has been sent to the Home PINX.

6.4.2.3 State PUMI-Divert

The current location of the PUM user is known and a pumiDivert invoke APDU has been sent to the Rerouteing PINX.

6.4.3 States at the Home PINX

The procedures for the Home PINX are written in terms of the following conceptual states existing within the ANF-PUMI Supplementary Service Control entity.

6.4.3.1 State HomeIdle

Ready for receipt of a pumiEnquiry APDU.

6.4.4 States at the Visitor PINX

The procedures for the Visitor PINX are written in terms of the following conceptual states existing within the ANF-PUMI Supplementary Service Control entity in that PINX in association with a particular call.

6.4.4.1 State VisitIdle

Ready for receipt of a pumiInform APDU.

6.5 ANF-PUMI signalling procedures for invocation and operation

Examples of message sequences are shown in annex C.

6.5.1 Actions at the Rerouteing PINX

The SDL representation of procedures at the Rerouteing PINX is shown in D.1 of annex D.

6.5.1.1 Normal procedures

On receipt of a pumiDivert invoke APDU in a FACILITY message during basic call protocol control state Outgoing Call Proceeding, the Rerouteing PINX shall determine whether it can proceed with ANF-PUMI. If so, it shall initiate a new call establishment to the Visitor PINX and release the leg towards the PUMI-detect PINX by sending a DISCONNECT message containing a pumiDivert return result APDU.

The SETUP message for the new call establishment shall include a pumiInform invoke APDU.

The following specific basic call information elements shall be included in the SETUP message:

- Called party number, containing the number received in the hostingAddr data element within the pumiDivert invoke APDU;
- Called party subaddress, containing the subaddress received in the pumUserSub data element within the pumiDivert invoke APDU (optional);
- Calling party number, containing the number received in the callingNumber data element within the pumiDivert invoke APDU;
- Calling party subaddress, containing the subaddress received in the callingUserSub data element within the pumiDivert invoke APDU (optional);
- Bearer capability information element as received in embedded form within the pumiDivert invoke APDU, and any of the following information elements which were also received in embedded form in this APDU: High layer compatibility, Low layer compatibility and Progress indicator information elements.

The pumiInform invoke APDU shall contain the data element pumIdentity with the same contents as the corresponding data element in the argument of the received pumiDivert invoke APDU.

6.5.1.2 Exceptional procedures

If the Rerouting PINX can not proceed with ANF-PUMI, it shall answer the pumiDivert invoke APDU with a return error APDU containing the error notAvailable.

6.5.2 Actions at the PUMI-detect PINX

The SDL representation of procedures at the PUMI-detect PINX is shown in D.2 of annex D.

When a PUMI-detect PINX also provides Rerouting PINX functionality, in support of ANF-PUMI by forward switching, the joint requirements of 6.5.1 (for a Rerouting PINX) and 6.5.2 (for a PUMI-detect PINX) shall apply, with the exception that any communication between the PUMI-detect PINX functionality and the Rerouting PINX functionality will be an intra-PINX matter. The messages specified for sending from the PUMI-detect PINX towards the Rerouting PINX or vice versa will not appear on any inter-PINX link.

6.5.2.1 Normal procedures

On determining that ANF-PUMI is to be invoked following the arrival of an incoming call, the PUMI-detect PINX shall send a pumiEnquiry invoke APDU to the Home PINX of the called PUM user, using the call reference of a call independent signalling connection. The call independent signalling connection shall be established (or used, if an appropriate connection is already available) in accordance with the procedures specified in 7.3 of ECMA-165. The PUMI-detect PINX shall enter state PUMI-Detected and start timer T1.

NOTE 3

The number to be used in the Called party number information element when establishing the call independent signalling connection to the Home PINX is outside the scope of this Standard. It can, for example, be the Called party number information element received in the incoming SETUP message.

The following data elements shall be included in the argument of the pumiEnquiry invoke APDU:

- element pismNumber as received in the incoming SETUP message in the Called party number information element;
- element qSIGInfoElement containing an embedded Bearer capability information element, as received in the incoming SETUP message, and any of the following information elements which were received in the incoming SETUP message: High layer compatibility and Low layer compatibility.

On receipt of the pumiEnquiry return result APDU containing choice currLocation, the PUMI-detect PINX shall stop timer T1, send a pumiDivert invoke APDU in a FACILITY message to the Rerouting PINX using the call reference of the incoming call, start timer T2 and enter state PUMI-Divert.

The following data elements shall be included in the argument of the pumiDivert invoke APDU:

- element hostingAddr as received in the pumiEnquiry return result APDU;
- element callingNumber as received in the incoming SETUP message in the Calling party number information element;
- element pumIdentity as received in the pumiEnquiry return result APDU;
- element qSIGInfoElement containing an embedded Bearer capability information element, as received in the incoming SETUP message, and any of the following information elements which were received in the incoming SETUP message: High layer compatibility, Low layer compatibility and Progress indicator;
- element callingUserSub, if a Calling party subaddress information element was received in the incoming SETUP message;
- element callingUserName, if a callingName invoke APDU was received in the incoming SETUP message as defined in ECMA-164 and if CNIP is supported;
- element pumUserSub, if a Called party subaddress information element was received in the incoming SETUP message.

On receipt of a pumiEnquiry return result APDU containing choice cfuActivated, if the PUMI-detect PINX does not support the procedures of 6.8.6.1 the actions taken shall be an implementation matter, e.g. route the incoming call onwards to the Home PINX or release the incoming call.

The PUMI-detect PINX is responsible for clearing the call independent signalling connection towards the Home PINX. This may occur on receipt of a return result APDU. Alternatively, the signalling connection may be retained for other applications, if appropriate.

On receipt of the pumiDivert return result APDU, the PUMI-detect PINX shall stop timer T2 and enter state PUMI-Idle.

6.5.2.2 Exceptional procedures

On receipt of a pumiEnquiry return error APDU from the Home PINX indicating 'invalidServedUserNr', the PUMI-detect PINX shall stop timer T1, stimulate the sending of a DISCONNECT message with cause value #1 'Unallocated (unassigned) number' for release of the basic call, and enter state PUMI-Idle.

On receipt of a pumiEnquiry return error APDU from the Home PINX indicating 'locationNotKnown', the PUMI-detect PINX shall stop timer T1, stimulate the sending of a DISCONNECT message with cause value #3 'No route to destination' for release of the basic call, and enter state PUMI-Idle.

On receipt of a pumiEnquiry return error APDU from the Home PINX indicating 'notAvailable', the PUMI-detect PINX shall stop timer T1, stimulate the sending of a DISCONNECT message with cause value #20 'Subscriber absent' for release of the basic call, and enter state PUMI-Idle.

On receipt of a pumiEnquiry return error APDU from the Home PINX indicating 'basicServiceNotProvided', the PUMI-detect PINX shall stop timer T1, stimulate the sending of a DISCONNECT message with cause value #88 'Incompatible destination' for release of the basic call, and enter state PUMI-Idle.

On receipt of a pumiEnquiry reject APDU from the Home PINX, the PUMI-detect PINX shall stop timer T1, enter state PUMI-Idle, and continue with normal basic call procedures.

If timer T1 expires (i.e. the pumiEnquiry invoke APDU is not answered by the Home PINX), the PUMI-detect PINX shall enter state PUMI-Idle and either stimulate the sending of a DISCONNECT message with cause value #41 'Temporary failure' for release of the basic call, or continue with normal basic call procedures.

On call clearing during state PUMI-Detected, the PUMI-detect PINX shall stop timer T1 and enter state PUMI-Idle.

On receipt of a pumiDivert return error or reject APDU from the Rerouting PINX, the PUMI-detect PINX shall stop timer T2, enter state PUMI-Idle, and either stimulate the sending of a DISCONNECT message for release of the basic call, or provide Rerouting PINX functionality locally by initiating a new call establishment to the Visitor PINX in accordance with 6.5.1.1.

If timer T2 expires (i.e. the pumiDivert invoke APDU is not answered by the Rerouting PINX), the PUMI-detect PINX shall enter state PUMI-Idle and either stimulate the sending of a DISCONNECT message for release of the basic call, or provide Rerouting PINX functionality locally by initiating a new call establishment to the Visitor PINX in accordance with 6.5.1.1.

On call clearing during state PUMI-Divert, the PUMI-detect PINX shall stop timer T2 and enter state PUMI-Idle.

The PUMI-detect PINX is responsible for clearing the call independent signalling connection towards the Home PINX. This may occur on receipt of a return error or reject APDU, on expiry of timer T1 or on call clearing during state PUMI-Detect. Alternatively, the signalling connection may be retained for other applications, if appropriate.

6.5.3 Actions at the Home PINX

The SDL representation of procedures at the Home PINX is shown in D.3 of annex D.

When a Home PINX also provides PUMI-detect PINX functionality, in support of ANF-PUMI, the joint requirements of 6.5.2 (for a PUMI-detect PINX) and 6.5.3 (for a Home PINX) shall apply, with the exception that any communication between the Home PINX functionality and the PUMI-detect PINX functionality will be an intra-PINX matter. The messages specified for sending from the Home PINX towards the PUMI-detect PINX or vice versa will not appear on any inter-PINX link.

6.5.3.1 Normal procedures

On receipt of a pumiEnquiry invoke APDU using the call reference of a call independent signalling connection (as specified in 7.3 of ECMA-165), the Home PINX shall check that the PUM user, as identified by the PISN number in element pismNumber, is defined in the HDB and that the basic service indicated by the basic call information elements embedded in element qSIGInfoElement is provided to that user.

If the PUM user is defined in the HDB, and the current location of the PUM user is known for the basic service concerned, then the Home PINX shall answer the pumiEnquiry invoke APDU with a return result APDU containing choice currLocation. Element hostingAddr shall contain the PISN number of the hosting user and element pumIdentity shall contain the PISN number and/or an alternative identifier of the PUM user. The PISN number, if included, shall be in the form of a complete number even if the PISN number received in the invoke APDU was not a complete number.

6.5.3.2 Exceptional procedures

If the PUM user is not found in the HDB, the Home PINX shall answer the pumiEnquiry invoke APDU with a return error APDU containing the error invalidServedUserNr.

If the PUM user has deregistered, the Home PINX shall answer the pumiEnquiry invoke APDU with a return error APDU containing the error notAvailable.

If the current location of the PUM user is unknown, the Home PINX shall answer the pumiEnquiry invoke APDU with a return error APDU containing the error locationNotKnown.

If the requested basic service is not provided, the Home PINX shall answer the pumiEnquiry invoke APDU with a return error APDU containing the error basicServiceNotProvided.

6.5.3.3 Additional procedures for Call Forwarding Unconditional

On receipt of a pumiEnquiry invoke APDU, if the PUM user is defined in the HDB and SS-CFU is active, the Home PINX shall answer the pumiEnquiry invoke APDU with a return result APDU containing choice cfuActivated.

6.5.4 Actions at the Visitor PINX

The SDL representation of procedures at the Visitor PINX is shown in D.4 of annex D.

6.5.4.1 Normal procedures

On receipt of a pumiInform invoke APDU in a SETUP message, the Visitor PINX may check that there is an entry in the VDB for the PUM user, as indicated by the PISN number or alternative identifier in element pumIdentity, for the basic service indicated by basic call information elements. In any case, the Visitor PINX shall attempt to establish the call to the TE that is indicated by the hosting address contained in the Called party number information element, including the pumIdentity in the call request.

6.5.4.2 Exceptional procedures

If the PUM user is not found in the VDB, the Visitor PINX may initiate call clearing according to the procedures in ECMA-143 with cause value #41 'Temporary failure'.

All call failure situations shall be handled according to basic call procedures as specified in ECMA-143.

6.5.5 Actions at a Transit PINX

There are no special actions required in support of ANF-PUMI.

6.5.6 Actions at an Originating PINX

An Originating PINX shall act as the Rerouteing PINX in accordance with 6.5.1, except where Rerouteing PINX functionality is provided at a separate PUMI-detect PINX.

6.6 ANF-PUMI impact of interworking with public ISDNs

When interworking with a public ISDN which does not support an equivalent feature, the Incoming Gateway PINX shall act as the Rerouteing PINX in accordance with 6.5.1 in order to perform ANF-PUMI within the PISN, except where Rerouteing PINX functionality is provided at a separate PUMI-detect PINX.

6.7 ANF-PUMI impact of interworking with non-ISDNs

When interworking with a non-ISDN which does not support an equivalent feature, the Incoming Gateway PINX shall act as the Rerouteing PINX in accordance with 6.5.1 in order to perform ANF-PUMI within the PISN, except where Rerouteing PINX functionality is provided at a separate PUMI-detect PINX.

6.8 Protocol interactions between ANF-PUMI and other supplementary services and ANFs

This clause specifies protocol interactions with other supplementary services and ANFs for which stage 3 standards had been published at the time of publication of this Standard. For interactions with supplementary services and ANFs for which stage 3 standards are published subsequent to the publication of this Standard, see those other stage 3 standards.

NOTE 4

Additional interactions that have no impact on the signalling protocol at the Q reference point can be found in the relevant stage 1 specifications.

NOTE 5

Simultaneous conveyance of APDUs for ANF-PUMI and other supplementary services or ANFs in the same message, each in accordance with the requirements of its respective stage 3 standard, does not, on its own, constitute a protocol interaction.

6.8.1 Interaction with Calling Name Identification Presentation (SS-CNIP)

The following interaction shall apply if SS-CNIP is supported in accordance with ECMA-164.

6.8.1.1 Actions at the Rerouteing PINX

When executing ANF-PUMI, the Rerouteing PINX shall include a callingName invoke APDU in the SETUP message to the Visitor PINX if this was included in the original SETUP message to the PUMI-detect PINX.

6.8.2 Interaction with Connected Name Identification Presentation (SS-CONP)

No protocol interaction.

6.8.3 Interaction with Call Completion to Busy Subscriber (SS-CCBS)

No protocol interaction.

6.8.4 Interaction with Call Completion on No Reply (SS-CCNR)

No protocol interaction.

6.8.5 Interaction with Call Transfer (SS-CT)

No protocol interaction.

6.8.6 Interaction with Call Forwarding Unconditional (SS-CFU)

The following interaction shall apply if SS-CFU is supported in accordance with ECMA-174.

6.8.6.1 Actions at the PUMI-detect PINX

On receipt of a pumiEnquiry return result APDU containing choice cfuActivated, the PUMI-detect PINX shall stop timer T1 and act as the Served User PINX for SS-CFU in accordance with 6.5.4 of ECMA-174.

The PUMI-detect PINX is responsible for clearing the call independent signalling connection towards the Home PINX. This may occur on receipt of a return result APDU. Alternatively, the signalling connection may be retained for other applications, if appropriate.

6.8.7 Interaction with Call Forwarding Busy (SS-CFB)

No protocol interaction.

6.8.8 Interaction with Call Forwarding No Reply (SS-CFNR)

No protocol interaction.

6.8.9 Interaction with Call Deflection (SS-CD)

No protocol interaction.

6.8.10 Interaction with Path Replacement (ANF-PR)

No protocol interaction.

6.8.11 Interaction with Call Offer (SS-CO)

The following interaction shall apply if SS-CO is supported in accordance with ECMA-192.

6.8.11.1 Actions at the Rerouteing PINX

When executing ANF-PUMI, the Rerouteing PINX shall act as follows:

- include a callOfferRequest invoke APDU in the SETUP message to the Visitor PINX if this was included in the original SETUP message to the PUMI-detect PINX;
- include a pathRetain invoke APDU with callOffer bit set to ONE in the SETUP message to the Visitor PINX if this was included in the original SETUP message to the PUMI-detect PINX.

6.8.12 Interaction with Call Intrusion (SS-CI)

The following interaction shall apply if SS-CI is supported in accordance with ECMA-203.

6.8.12.1 Actions at the Rerouteing PINX

When executing ANF-PUMI, the Rerouteing PINX shall act as follows:

- include a callIntrusionRequest invoke APDU in the SETUP message to the Visitor PINX if this was included in the original SETUP message to the PUMI-detect PINX;
- include a pathRetain invoke APDU with bit ci-low, ci-medium or ci-high set to ONE in the SETUP message to the Visitor PINX if this was included in the original SETUP message to the PUMI-detect PINX.

6.8.13 Interaction with Do Not Disturb (SS-DND)

No protocol interaction.

6.8.14 Interaction with Do Not Disturb Override (SS-DNDO)

The following interaction shall apply if SS-DNDO is supported in accordance with ECMA-194.

6.8.14.1 Actions at the Rerouteing PINX

When executing ANF-PUMI, the Rerouteing PINX shall act as follows:

- include a doNotDisturbOverrideQ invoke APDU in the SETUP message to the Visitor PINX if this was included in the original SETUP message to the PUMI-detect PINX;
- include a pathRetain invoke APDU with bit dndo-low, dndo-medium or dndo-high set to ONE in the SETUP message to the Visitor PINX if this was included in the original SETUP message to the PUMI-detect PINX.

6.8.15 Interaction with Advice Of Charge (SS-AOC)

The following interaction shall apply if SS-AOC is supported in accordance with ECMA-212.

6.8.15.1 Actions at the Rerouting PINX

When executing ANF-PUMI, the Rerouteing PINX shall include a chargeRequest invoke APDU in the SETUP message to the Visitor PINX if this was included in the original SETUP message to the PUMI-detect PINX.

On receipt of a pumiDivert invoke APDU for a call independent signalling connection which conveys an aocFinal invoke APDU, the Rerouteing PINX shall act in accordance to 6.5.1, except that the basic call procedures are replaced by the corresponding procedures for call independent signalling connections as specified in ECMA-165 clause 7.3, and shall include the aocFinal invoke APDU of the original received in the SETUP message sent to the Visitor PINX.

6.8.15.2 Actions at the PUMI-detect PINX

On receipt of a SETUP message for a call independent signalling connection which conveys an aocFinal invoke APDU, the PUMI-detect PINX shall act in accordance to 6.5.2, except that the basic call procedures are replaced by the corresponding procedures for call independent signalling connections as specified in ECMA-165 clause 7.3.

6.8.15.3 Actions at the Visitor PINX

On receipt of a SETUP message for a call independent signalling connection which conveys an aocFinal invoke APDU and a pumiInform invoke APDU, the joint requirements of 6.5.4, except that the basic call procedures are replaced by the corresponding procedures for call independent signalling connections as specified in ECMA-165 clause 7.3, and 6.9.3.1 of ECMA-212 for an Originating PINX shall apply.

6.8.16 Interaction with Recall (SS-RE)

No protocol interaction.

6.8.17 Interaction with Call Interception (ANF-CINT)

No protocol interaction.

6.8.18 Interaction with Transit Counter (ANF-TC)

The following interaction shall apply if ANF-TC is supported in accordance with ECMA-225.

6.8.18.1 Actions at the Rerouteing PINX

When executing ANF-PUMI, the Rerouteing PINX may include a Transit counter information element in the SETUP message to the Visitor PINX. The value of the transit count field shall be zero.

6.8.19 Interaction with Route Restriction Class (ANF-RRC)

The following interaction shall apply if ANF-RRC is supported in accordance with ISO/IEC 13241.

6.8.19.1 Actions at the Rerouteing PINX

When executing ANF-PUMI, the Rerouteing PINX shall include a routeRestrictionClass invoke APDU in the SETUP message to the Visitor PINX if this was included in the original SETUP message to the PUMI-detect PINX. The element rac shall be the Route Access Class of either the calling user or the PUM user.

6.8.19.2 Actions at the PUMI-detect PINX

The PUMI-detect PINX may include a routeRestrictionClass invoke APDU received from the Home PINX, with element rac containing the Route Access Class of the PUM user, together with the pumiDivert invoke APDU in the FACILITY message to the Rerouteing PINX.

6.8.19.3 Actions at the Home PINX

The Home PINX may include a routeRestrictionClass invoke APDU, with element rac containing the Route Access Class of the PUM user, together with the pumiEnquiry return result APDU in the message to the PUMI-detect PINX.

6.8.20 Interaction with Message Waiting Indication (SS-MWI)

The following interaction shall apply in case of an active InCall or AllCall registration if SS-MWI is supported in accordance with ECMA-242.

6.8.20.1 Actions at the Rerouteing PINX

On receipt of a pumiDivert invoke APDU using the call reference of a call independent signalling connection which conveys a mwiActivate or mwiDeactivate invoke APDU, the Rerouteing PINX shall act in accordance with 6.5.1, except that basic call procedures are replaced by the corresponding procedures for call independent signalling connections as specified in ECMA-165 clause 7.3, and include the mwiActivate / mwiDeactivate invoke APDU in the SETUP message sent to the Visitor PINX.

6.8.20.2 Actions at the PUMI-detect PINX

On receipt of a SETUP message for a call independent signalling connection containing a mwiActivate or mwiDeactivate invoke APDU the PUMI-detect PINX may act in accordance with 6.5.2, except that basic call procedures are replaced by the corresponding procedures for call independent signalling connections as specified in ECMA-165 clause 7.3.

NOTE 6

If the PUMI-detect PINX does not act on an incoming mwiActivate or mwiDeactivate invoke APDU the APDU will pass through to the Home PINX.

6.8.20.3 Actions at the Home PINX

On receipt of a SETUP message using the call reference of a call independent signalling connection and containing a mwiActivate or mwiDeactivate invoke APDU, the Home PINX may forward the mwiActivate / mwiDeactivate invoke APDU to the Visitor PINX, using a call independent signalling connection. The Home PINX shall also forward to the Message Centre PINX any mwiActivate / mwiDeactivate return result, return error or reject APDU subsequently returned by the Visitor PINX.

NOTE 7

Other actions, e.g. recording the status of SS-MWI for the PUM user, are outside the scope of this Standard.

6.8.20.4 Actions at the Visitor PINX

The Visitor PINX shall act as the SS-MWI Served User PINX for a visiting PUM user which is also a served user of SS-MWI.

NOTE 8

A message waiting indication may be lost if the PUM user moves or has moved to another location.

6.8.21 Interaction with Wireless Terminal Location Registration (SS-WTLR)

No protocol interaction.

6.8.22 Interaction with Wireless Terminal Incoming Call (ANF-WTMI)

The following interaction shall apply if ANF-WTMI is supported in accordance with ECMA-304.

6.8.22.1 Actions at the WTMI Rerouteing PINX

If a call is routed by means of ANF-WTMI and if the received SETUP message contained a pumiInform invoke APDU, the WTMI Rerouteing PINX shall include the pumiInform invoke APDU in the SETUP message to the Visitor PINX, in addition to the wtmiInform invoke APDU.

6.8.22.2 Actions at the Visitor PINX

In addition to normal ANF-WTMI procedures the Visitor PINX shall include the pumIdentity in the call request to the current access of the PUM/WTM user.

6.8.23 Interaction with Wireless Terminal Outgoing Call (ANF-WTMO)

No protocol interaction.

6.8.24 Interaction with Wireless Terminal Authentication of the Terminal (SS-WTAT)

No protocol interaction.

6.8.25 Interaction with Wireless Terminal Authentication of the Network (SS-WTAN)

No protocol interaction.

6.8.26 Interaction with Private User Mobility Registration (ANF-PUMR)

No protocol interaction.

6.8.27 Interaction with Private User Mobility Outgoing Call (ANF-PUMO)

The following interaction shall apply if ANF-PUMO is supported in accordance with clause 7.

6.8.27.1 Actions at the PUMI-detect PINX

If a SETUP message contains a pumoCall invoke APDU then ANF-PUMI shall not be invoked on this call.

6.8.28 Interactions with Common Information (ANF-CMN)

The following interaction shall apply if ANF-CMN is supported in accordance with ECMA-251.

6.8.28.1 Actions at the Rerouteing PINX

When executing ANF-PUMI, the Rerouteing PINX shall include a cmnRequest invoke APDU (for the ANF-CMN solicited service) or a cmnInform invoke APDU (for the unsolicited service) in the SETUP message to the Visitor PINX if this was included in the SETUP message to the PUMI-detect PINX.

6.8.29 Interaction with Call Priority Interruption (Protection) (SS-CPI(P))

The following interaction shall apply if SS-CPI(P) is supported in accordance with ECMA-264.

6.8.29.1 Actions at the Rerouteing PINX

On receiving a pumiDivert invoke APDU, the Rerouteing PINX shall include in the SETUP message sent to the Visitor PINX any callInterruptionRequest invoke APDU or callProtectionRequest invoke APDU accompanying the pumiDivert invoke APDU.

6.8.29.2 Actions at the PUMI-detect PINX

If the incoming call for which ANF-PUMI is to be invoked contains a callInterruptionRequest invoke APDU or a callProtectionRequest invoke APDU, the PUMI-detect PINX shall include these APDUs with the pumiDivert invoke APDU in the FACILITY message sent to the Rerouteing PINX.

6.9 ANF-PUMI parameter values (timers)

6.9.1 Timer T1

Timer T1 operates at the PUMI-detect PINX during state PUMI-Detected. Its purpose is to protect against the absence of a response to the pumiEnquiry invoke APDU.

Timer T1 shall have a value not less than 15 s.

6.9.2 Timer T2

Timer T2 operates at the PUMI-detect PINX during state PUMI-Divert. Its purpose is to protect against the absence of a response to the pumiDivert invoke APDU.

Timer T2 shall have a value not less than 15 s.

7 Signalling protocol for the support of ANF-PUMO

7.1 ANF-PUMO description

ANF-PUMO permits the PISN to optionally process call requests from a PUM user at the home location, if required.

NOTE 9

Further actions that may be performed at the visited location - verification of the PUM user's identity, local access to the service profile, local call processing - are outside the scope of this Standard.

7.2 ANF-PUMO operational requirements

7.2.1 Requirements on the Originating PINX

Call establishment procedures for the outgoing side of an inter-PINX link and call release procedures, as specified in ECMA-143, shall apply.

Generic procedures for the call related control of supplementary services, as specified in ECMA-165 for an End PINX, shall apply.

7.2.2 Requirements on the Home PINX

Call establishment procedures for the incoming and outgoing side of an inter-PINX link and call release procedures, as specified in ECMA-143, shall apply.

Generic procedures for the call related control of supplementary services, as specified in ECMA-165 for an End PINX, shall apply.

7.2.3 Requirements on a Transit PINX

Basic call procedures for call establishment and call clearing at a Transit PINX, as specified in ECMA-143, shall apply.

Generic procedures for the call related control of supplementary services, as specified in ECMA-165 for a Transit PINX, shall apply.

7.3 ANF-PUMO coding requirements

7.3.1 Operations

The operation pumoCall defined in Abstract Syntax Notation number 1 (ASN.1) in 6.3.1, table 1, shall apply.

7.3.2 Information elements

7.3.2.1 Facility information element

The operation defined in 7.3.1 shall be coded in the Facility information element in accordance with ECMA-165.

The Facility information element shall always contain an NFE with the destinationEntity element having value endPINX.

A Facility information element conveying a pumoCall invoke APDU shall also contain an Interpretation APDU with value clearCallIfAnyInvokePduNotRecognised. If sent in a FACILITY message, the Interpretation APDU shall either be omitted or included with value rejectAny-UnrecognisedInvokePdu.

7.3.2.2 Other information elements

Any other information elements (e.g. Calling party number, Called party number) shall be coded in accordance with the rules of ECMA-143 and ECMA-165.

7.3.3 Messages

The Facility information element shall be conveyed in the messages as specified in clause 10 of ECMA-165.

7.4 ANF-PUMO State definitions

7.4.1 States at the Originating PINX

The procedures for the Originating PINX are written in terms of the following conceptual states existing within the ANF-PUMO Supplementary Service Control entity in that PINX in association with a particular PUMO Request.

7.4.1.1 PUMO-Idle

ANF-PUMO is not operating.

7.4.2 States at the Home PINX

The procedures for the Home PINX are written in terms of the following conceptual states existing within the ANF-PUMO Supplementary Service Control entity in that PINX in association with a particular PUMO Request.

7.4.2.1 PUMO-Idle

Ready for receipt of a pumoCall invoke APDU.

7.4.2.2 PUMO-Await-Info

Further address information can be received in overlap mode.

7.5 ANF-PUMO signalling procedures

Examples of message sequences are shown in annex C.

7.5.1 Actions at the Originating PINX

The SDL representation of procedures at the Originating PINX is shown in D.5 of annex D.

7.5.1.1 Normal procedures

If the Originating PINX decides to pass to the Home PINX for processing a call request that was initiated by the PUM user, the Originating PINX shall send a SETUP message according to ECMA-143 to the Home PINX. The SETUP message shall contain a pumoCall invoke APDU, in the Calling party number information element the number of the PUM user if available, and in the Called party number information element a number sufficient to route to the PUM user's Home PINX. If the PUM user's number is not available, the alternative identifier shall be included in the element pumIdentity of the invoke APDU's argument. If (part of) the intended destination number is already available it shall be included in element destinationNumber of the invoke APDU's argument. If the destination number is complete, element sendingComplete may also be included in the argument.

NOTE 10

The number to be used in the Called party number information element is outside the scope of this Standard. It could, for example, be the number of the PUM user.

Subsequently, if the destination number sent in the SETUP message was not complete, additional address information from the PUM user shall be included in the argument of pumoCall invoke APDUs, which shall be sent to the Home PINX in FACILITY messages, with the digit(s) encoded in element destinationNumber. The end of number information transmission may be indicated to the Home PINX by means of a sendingComplete element.

7.5.1.2 Exceptional procedures

Not applicable.

7.5.2 Actions at the Home PINX

The SDL representation of procedures at the Home PINX is shown in D.6 of annex D.

7.5.2.1 Normal procedures

If on receipt of a SETUP message with a pumoCall invoke APDU enough digits of the destination number are present in the argument of the APDU to select a route for call extension, the Home PINX shall initiate call establishment towards the intended destination in accordance with ECMA-143 and join the two call legs. If the PUM user's number is not included in the Calling Party element of the received SETUP message, the alternative identifier from the element pumIdentity in the invoke APDU argument may be used to determine the PUM user's number before attempting to establish a call

towards the intended destination number. If the destination number is not complete, the Home PINX shall enter state PUMO-Await-Info, optionally send a PROGRESS message with progress description number 8 to the Originating PINX to stop T310 at Transit PINXs, and start timer T3. Otherwise it shall remain in state PUMO-Idle.

NOTE 11

The only purpose of this progress description is to stop timer T310. It does not mean that in-band information is necessarily provided.

While in state PUMO-Await-Info, additional number information received as argument of pumoCall invoke APDUs in a FACILITY message shall be used to select a route for call extension or, if the call has already been extended, passed on to the Subsequent PINX in accordance with ECMA-143. If the Home PINX regards the number information complete it shall stop timer T3, initiate call establishment towards the intended destination in accordance with ECMA-143 if not already done, join the two call legs, and return to state PUMO-Idle. Otherwise it shall restart timer T3 and stay in state PUMO-Await-Info.

If a sendingComplete element is contained in a pumoCall invoke APDU received while in state PUMO-Await-Info, the Home PINX shall process any number information present in the argument, stop timer T3, initiate call establishment towards the intended destination in accordance with ECMA-143 if not already done, join the two call legs, and return to state PUMO-Idle.

7.5.2.2 Exceptional procedures

If timer T3 expires the Home PINX shall return to state PUMO-Idle and

- if the number information received so far is considered sufficient, initiate call establishment towards the intended destination in accordance with ECMA-143, if not already done, and join the two call legs;
- if the information is not sufficient to proceed, initiate call clearing with an appropriate cause value, e.g. #28 'invalid number format (address incomplete)'.

A pumoCall invoke APDU received in a FACILITY message while in state PUMO-Idle shall be ignored.

7.5.3 Actions at the Transit PINX

No special actions are required for ANF-PUMO.

7.6 ANF-PUMO impact of interworking with public ISDNs

Not applicable.

7.7 ANF-PUMO impact of interworking with non-ISDNs

Not applicable.

7.8 Protocol interactions between ANF-PUMO and other supplementary services and ANFs

This clause specifies protocol interactions with other supplementary services and ANFs for which stage 3 standards had been published at the time of publication of this Standard. For interactions with supplementary services and ANFs for which stage 3 standards are published subsequent to the publication of this Standard, see those other stage 3 standards.

NOTE 12

Additional interactions that have no impact on the signalling protocol at the Q reference point can be found in the relevant stage 1 specifications.

NOTE 13

Simultaneous conveyance of APDUs for ANF-PUMO and another supplementary service or ANF in the same message, each in accordance with the requirements of its respective stage 3 standard, does not, on its own, constitute a protocol interaction.

NOTE 14

The transmission of a Facility information element on one leg as a result of receiving a Facility information element on the other leg does not constitute a protocol interaction.

NOTE 15

If the Home PINX acts as the Originating PINX with regards to supplementary services is outside the scope of this Standard.

7.8.1 Interaction with Calling Name Identification Presentation (SS-CNIP)

The following interaction shall apply if SS-CNIP is supported in accordance with ECMA-164.

7.8.1.1 Actions at the Home PINX

The Home PINX may include a callingName invoke APDU in the SETUP message, indicating the name of the PUM user.

7.8.2 Interaction with Connected Name Identification Presentation (SS-CONP)

No protocol interaction.

7.8.3 Interaction with Call Completion to Busy Subscriber (SS-CCBS)

No protocol interaction.

7.8.4 Interaction with Call Completion on No Reply (SS-CCNR)

No protocol interaction.

7.8.5 Interaction with Call Transfer (SS-WT)

No protocol interaction.

7.8.6 Interaction with Call Diversion (SS-CFU, SS-CFB, SS-CFNR, SS-CD)

The following interaction shall apply if call diversion is supported in accordance with ECMA-174.

7.8.6.1 Actions at the Home PINX

On receipt of a callRerouting invoke APDU the Home PINX may act as the Rerouting PINX.

7.8.7 Interaction with Path Replacement (ANF-PR)

The following interaction shall apply if ANF-PR is supported in accordance with ECMA-176.

7.8.7.1 Actions at the Home PINX

The Home PINX may act as the Cooperating PINX when receiving a prPropose invoke APDU from either side.

7.8.8 Interaction with Call Offer (SS-CO)

No protocol interaction.

7.8.9 Interaction with Call Intrusion (SS-CI)

No protocol interaction.

7.8.10 Interaction with Do Not Disturb (SS-DND)

No protocol interaction.

7.8.11 Interaction with Do Not Disturb Override (SS-DNDO)

No protocol interaction.

7.8.12 Interaction with Advice of Charge (SS-AOC)

No protocol interaction.

7.8.13 Interaction with Recall (SS-RE)

No protocol interaction.

7.8.14 Interaction with Call Interception (ANF-CINT)

The following interaction shall apply if ANF-CINT is supported in accordance with ECMA-221.

7.8.14.1 Actions at the Home PINX

The Home PINX may act as Intercepting PINX.

7.8.15 Interaction with Transit Counter (ANF-TC)

The following interaction shall apply if ANF-TC is supported in accordance with ECMA-225.

7.8.15.1 Actions at the Home PINX

When executing ANF-PUMO, the Home PINX may include a Transit counter information element in the SETUP message.

7.8.16 Interaction with Route Restriction Class (ANF-RRC)

The following interaction shall apply if ANF-RRC is supported in accordance with ISO/IEC 13241.

7.8.16.1 Actions at the Home PINX

When executing ANF-PUMO, the Home PINX may include a routeRestrictionClass invoke APDU in the SETUP message, indicating the Route Access Class of the PUM user.

7.8.17 Interaction with Message Waiting Indication (SS-MWI)

No protocol interaction.

7.8.18 Interaction with Wireless Terminal Location Registration (SS-WTLR)

No protocol interaction.

7.8.19 Interaction with Wireless Terminal Incoming Call (ANF-WTMI)

No protocol interaction.

7.8.20 Interaction with Wireless Terminal Outgoing Call (ANF-WTMO)

No protocol interaction.

7.8.21 Interaction with Wireless Terminal Authentication of the Terminal (SS-WTAT)

No protocol interaction.

7.8.22 Interaction with Wireless Terminal Authentication of the Network (SS-WTAN)

No protocol interaction.

7.8.23 Interaction with Private User Mobility Registration (ANF-PUMR)

No protocol interaction.

7.8.24 Interaction with Private User Mobility Incoming Call (ANF-PUMI)

This interaction is specified in 6.8.27.

7.8.25 Interaction with Common Information (ANF-CMN)

No protocol interaction.

7.8.26 Interaction with Call Priority Interruption (Protection) (SS-CPI(P))

No protocol interaction.

7.9 Parameter values (timers)

7.9.1 Timers at the Originating PINX

None.

7.9.2 Timers at the Home PINX

T3 Information receiving

This timer is started on receipt of the first pumoCall invoke APDU with incomplete number information, restarted on receipt of a further pumoCall invoke APDU with incomplete number information, and stopped when a pumoCall invoke APDU containing final number information or an element sendingComplete is received from the Originating PINX or an ALERTING or CONNECT message is received from the Terminating PINX.

On expiry of timer T3 the call is either cleared or proceeds as normal basic call.

The value of timer T3 should be in the range 14 - 16 seconds.

Annex A (normative)

Protocol Implementation Conformance Statement (PICS) proforma

A.1 Introduction

The supplier of a protocol implementation which is claimed to conform to this Standard shall complete the following Protocol Implementation Conformance Statement (PICS) proforma.

A completed PICS proforma is the PICS for the implementation in question. The PICS is a statement of which capabilities and options of the protocol have been implemented. The PICS can have a number of uses, including use:

- by the protocol implementor, as a check list to reduce the risk of failure to conform to the Standard through oversight;
- by the supplier and acquirer, or potential acquirer, of the implementation, as a detailed indication of the capabilities of the implementation, stated relative to the common basis for understanding provided by the Standard's PICS proforma;
- by the user or potential user of the implementation, as a basis for initially checking the possibility of interworking with another implementation - while interworking can never be guaranteed, failure to interwork can often be predicted from incompatible PICS's.
- by a protocol tester, as the basis for selecting appropriate tests against which to assess the claim for conformance of the implementation.

A.2 Instructions for completing the PICS proforma

A.2.1 General structure of the PICS proforma

The PICS proforma is a fixed format questionnaire divided into subclauses each containing a group of individual items. Each item is identified by an item number, the name of the item (question to be answered), and the reference(s) to the clause(s) specifying the item in the main body of this Standard.

The "Status" column indicates whether an item is applicable and if so whether support is mandatory or optional. The following terms are used:

m	mandatory (the capability is required for conformance to the protocol);
o	optional (the capability is not required for conformance to the protocol, but if the capability is implemented it is required to conform to the protocol specifications);
o.<n>	optional, but support of at least one of the group of options labelled by the same numeral <n> is required;
x	prohibited;
c.<cond>	conditional requirement, depending on support for the item or items listed in condition <cond>;
<item>:m	simple conditional requirement, the capability being mandatory if item number <item> is supported, otherwise not applicable;
<item>:o	simple conditional requirement, the capability being optional if item number <item> is supported, otherwise not applicable.

Answers to the questionnaire items are to be provided either in the "Support" column, by simply marking an answer to indicate a restricted choice (Yes or No), or in the "Not Applicable" column (N/A).

A.2.2 Additional information

Items of Additional Information allow a supplier to provide further information intended to assist the interpretation of the PICS. It is not intended or expected that a large quantity will be supplied, and a PICS can be considered complete without any such information. Examples might be an outline of the ways in which a (single) implementation can be set up to operate in a variety of environments and configurations.

References to items of Additional Information may be entered next to any answer in the questionnaire, and may be included in items of Exception information.

A.2.3 Exception information

It may occasionally happen that a supplier will wish to answer an item with mandatory or prohibited status (after any conditions have been applied) in a way that conflicts with the indicated requirement. No pre-printed answer will be found in the Support column for this. Instead, the supplier is required to write into the Support column an x.<i> reference to an item of Exception Information, and to provide the appropriate rationale in the Exception item itself.

An implementation for which an Exception item is required in this way does not conform to this Standard. A possible reason for the situation described above is that a defect in the Standard has been reported, a correction for which is expected to change the requirement not met by the implementation.

A.3 PICS proforma for ANF-PUMI

A.3.1 Implementation Identification

Supplier	
Contact point for queries about the PICS	
Implementation Name(s) and Version(s)	
Other information necessary for full identification, e.g., name(s) and version(s) for machines and/or operating systems; system name(s)	

Only the first three items are required for all implementations; other information may be completed as appropriate in meeting the requirement for full identification.

The terms Name and Version should be interpreted appropriately to correspond with a supplier's terminology (e.g., Type, Series, Model).

A.3.2 Protocol Summary

Protocol Version	1.0
Addenda Implemented (if applicable)	
Amendments Implemented	
Have any exception items been required (see A.2.3) ?	No [] Yes [] (The answer YES means that the implementation does not conform to this Standard)
Date of Statement	

A.3.3 General

Item	Question/feature	References	Status	N/A	Support
A1	Support of ANF-PUMI, call rerouting		o.1		Yes [] No []
A2	Support of ANF-PUMI, forward switching		o.1		Yes [] No []
A3	Behaviour as PUMI-detect PINX		c.1	[]	o: Yes [] No []
A4	Behaviour as Home PINX for ANF-PUMI		c.1	[]	o: Yes [] No []
A5	Behaviour as Visitor PINX for ANF-PUMI		c.1	[]	o: Yes [] No []
A6	Behaviour as Originating PINX for ANF-PUMI		c.1	[]	o: Yes [] No []
A7	Behaviour as Incoming Gateway PINX		c.1	[]	o: Yes [] No []
A8	Behaviour as Rerouting PINX		c.2	[]	m: Yes []
A9	Support of relevant procedures of ECMA-143 and ECMA-165	6.2	m		Yes []

c.1: if A1 or A2 then o.2 else N/A

c.2: if (A1 and (A6 or A7)) or (A2 and A3) then mandatory else N/A

A.3.4 Procedures

Item	Question/feature	References	Status	N/A	Support
B1	Signalling procedures at a Rerouting PINX	6.5.1	A8:m	[]	m: Yes []
B2	Signalling procedures at a PUMI-detect PINX	6.5.2	A3:m	[]	m: Yes []
B3	Signalling procedures at a Home PINX	6.5.3.1 6.5.3.2	A4:m	[]	m: Yes []
B4	Signalling procedures at a Visitor PINX	6.5.4	A5:m	[]	m: Yes []
B5	Additional procedures at a Home PINX for Call Forwarding Unconditional	6.5.3.3	A4:o	[]	o: Yes [] No []

A.3.5 Coding

Item	Question/feature	References	Status	N/A	Support
C1	Receipt of pumiDivert invoke APDU and sending of return result and return error APDUs	6.3	c.1	[]	m: Yes []
C2	Sending of pumiInform invoke APDU	6.3	A8:m	[]	m: Yes []
C3	Sending of pumiEnquiry invoke APDU and receipt of return result and return error APDUs	6.3	A3:m	[]	m: Yes []
C4	Sending of pumiDivert invoke APDU and receipt of return result and return error APDUs	6.3	c.2	[]	m: Yes []
C5	Receipt of pumiEnquiry invoke APDU and sending of return result and return error APDUs	6.3	A4:m	[]	m: Yes []
C6	Receipt of pumiInform invoke APDU	6.3	A5:m	[]	m: Yes []

c.1: if A1 and A8 then mandatory else N/A

c.2: if A1 and A3 then mandatory else N/A

A.3.6 Timers

Item	Question/feature	References	Status	N/A	Support
D1	Support of Timer T1	6.9.1	A3:m	[]	m: Yes [] Value [. . . .]
D2	Support of Timer T2	6.9.2	c.1	[]	m: Yes [] Value [. . . .]

c.1: if A1 and A3 then mandatory else N/A

A.3.7 Interactions between ANF-PUMI and SS-CNIP

Item	Question/feature	References	Status	N/A	Support
E1	Support of SS-CNIP	ECMA-164	o		Yes [] No []
E2	Interactions at Rerouteing PINX	6.8.1.1	c.1	[]	m: Yes []

c.1: if E1 and A8 then mandatory, else N/A

A.3.8 Interactions between ANF-PUMI and SS-CFU

Item	Question/feature	References	Status	N/A	Support
F1	Support of SS-CFU	ECMA-174	o		Yes [] No []
F2	Interactions at PUMI-detect PINX	6.8.6.1	c.1	[]	m: Yes []

c.1: if F1 and A3 then mandatory, else N/A

A.3.9 Interactions between ANF-PUMI and SS-CO

Item	Question/feature	References	Status	N/A	Support
G1	Support of SS-CO	ECMA-192	o		Yes [] No []
G2	Interactions at Rerouteing PINX	6.8.11.1	c.1	[]	m: Yes []

c.1: if G1 and A8 then mandatory, else N/A

A.3.10 Interactions between ANF-PUMI and SS-CI

Item	Question/feature	References	Status	N/A	Support
H1	Support of SS-CI	ECMA-203	o		Yes [] No []
H2	Interactions at Rerouteing PINX	6.8.12.1	c.1	[]	m: Yes []

c.1: if H1 and A8 then mandatory, else N/A

A.3.11 Interactions between ANF-PUMI and SS-DNDO

Item	Question/feature	References	Status	N/A	Support
I1	Support of SS-DNDO	ECMA-194	o		Yes [] No []
I2	Interactions at Rerouteing PINX	6.8.14.1	c.1	[]	m: Yes []

c.1: if I1 and A8 then mandatory, else N/A

A.3.12 Interactions between ANF-PUMI and SS-AOC

Item	Question/feature	References	Status	N/A	Support
J1	Support of SS-AOC	ECMA-212	o		Yes [] No []
J2	Interactions at Rerouteing PINX	6.8.15.1	c.1	[]	m: Yes []
J3	Interactions at PUMI-detect PINX	6.8.15.2	c.2	[]	m Yes []
J4	Interactions at Visitor PINX	6.8.15.3	c.3	[]	m Yes []

c.1: if J1 and A8 then mandatory, else N/A

c.2: if J1 and A3 then mandatory, else N/A

c.3: if J1 and A5 then mandatory, else N/A

A.3.13 Interactions between ANF-PUMI and ANF-TC

Item	Question/feature	References	Status	N/A	Support
K1	Support of ANF-TC	ECMA-225	o		Yes [] No []
K2	Interactions at Rerouteing PINX	6.8.18.1	c.1	[]	o: Yes [] No []

c.1: if K1 and A8 then optional, else N/A

A.3.14 Interactions between ANF-PUMI and ANF-RRC

Item	Question/feature	References	Status	N/A	Support
L1	Support of ANF-RRC	ISO/IEC 13241	o		Yes [] No []
L2	Interactions at Rerouteing PINX	6.8.19.1	c.1	[]	m: Yes []
L3	Interactions at PUMI-detect PINX	6.8.19.2	c.2	[]	o: Yes [] No []
L4	Interactions at Home PINX	6.8.19.3	c.3	[]	o: Yes [] No []

c.1: if L1 and A8 then mandatory, else N/A
c.2: if L1 and A3 then optional, else N/A
c.3: if L1 and A4 then optional, else N/A

A.3.15 Interactions between ANF-PUMI and SS-MWI

Item	Question / feature	References	Status	N/A	Support
M1	Support of SS-MWI	ECMA-242	o		Yes [] No []
M2	Interactions at Rerouteing PINX	6.8.20.1	c.1	[]	m: Yes []
M3	Interactions at PUMI-detect PINX	6.8.20.2	c.2	[]	o: Yes [] No []
M4	Interactions at Home PINX	6.8.20.3	c.3	[]	o: Yes [] No []
M5	Interactions at Visitor PINX	6.8.20.4	c.4	[]	m: Yes []

c.1: if M1 and A8 then mandatory, else N/A
c.2: if M1 and A3 then optional, else N/A
c.3: if M1 and A4 then optional, else N/A
c.4: if M1 and A5 then mandatory, else N/A

A.3.16 Interactions between ANF-PUMI and ANF-WTMI

Item	Question / feature	References	Status	N/A	Support
N1	Support of ANF-WTMI	ECMA-304	o		Yes [] No []
N2	Interactions at WTMI Rerouteing PINX	6.8.22.1	N1:m	[]	m: Yes []
N3	Interactions at Visitor PINX	6.8.22.2	c.1	[]	m: Yes []

c.1: if N1 and A5 then mandatory, else N/A

A.3.17 Interactions between ANF-PUMI and ANF-PUMO

Item	Question / feature	References	Status	N/A	Support
O1	Support of ANF-PUMO	7	o		Yes [] No []
O2	Interactions at PUMI-detect PINX	6.8.27.1	c.1	[]	m: Yes []

c.1: if O1 and A3 then mandatory, else N/A

A.3.18 Interactions between ANF-PUMI and ANF-CMN

Item	Question/feature	References	Status	N/A	Support
P1	Support of ANF-CMN	ECMA-251	o		Yes [] No []
P2	Interactions at Rerouteing PINX	6.8.28.1	c.1	[]	m: Yes []

c.1: if P1 and A8 then mandatory, else N/A

A.3.19 Interactions between ANF-PUMI and SS-CPI(P)

Item	Question/feature	References	Status	N/A	Support
Q1	Support of SS-CPI(P)	ECMA-264	o		Yes [] No []
Q2	Interactions at Rerouteing PINX	6.8.29.1	c.1	[]	m: Yes []
Q3	Interactions at PUMI-detect PINX	6.8.29.2	c.2	[]	m: Yes []

c.1: if Q1 and A8 then mandatory, else N/A

c.2: if Q1 and A3 then mandatory, else N/A

A.4 PICS proforma for ANF-PUMO

A.4.1 Implementation Identification

Supplier	
Contact point for queries about the PICS	
Implementation Name(s) and Version(s)	
Other information necessary for full identification, e.g., name(s) and version(s) for machines and/or operating systems; system name(s)	

Only the first three items are required for all implementations; other information may be completed as appropriate in meeting the requirement for full identification.

The terms Name and Version should be interpreted appropriately to correspond with a supplier's terminology (e.g., Type, Series, Model).

A.4.2 Protocol Summary

Protocol Version	1.0
Addenda Implemented (if applicable)	
Amendments Implemented	
Have any exception items been required (see A.2.3) ?	No [] Yes [] (The answer YES means that the implementation does not conform to this Standard)
Date of Statement	

A.4.3 General

Item	Question/feature	References	Status	N/A	Support
A1	Behaviour as Originating PINX for ANF-PUMO		o.1		Yes [] No []
A2	Behaviour as Home PINX for ANF-PUMO		o.1		Yes [] No []
A3	Support of relevant procedures of ECMA-143 and ECMA-165	7.2	m		Yes []

A.4.4 Procedures

Item	Question / feature	References	Status	N/A	Support
B1	PUMO procedures at Originating PINX	7.5.1	A1:m	[]	m: Yes []
B2	PUMO procedures at Home PINX	7.5.2	A2:m	[]	m: Yes []

A.4.5 Coding

Item	Question / feature	References	Status	N/A	Support
C1	Sending of pumoCall invoke APDU	7.3.1	A1:m	[]	m: Yes []
C2	Receipt of pumoCall invoke APDU	7.3.1	A2:m	[]	m: Yes []

A.4.6 Timers

Item	Question / feature	References	Status	N/A	Support
D1	Support of timer T3	7.9.2	A2:m	[]	m: Yes [] Value:

A.4.7 Interactions between ANF-PUMO and SS-CNIP

Item	Question/feature	References	Status	N/A	Support
E1	Support of SS-CNIP	ECMA-164	o		Yes [] No []
E2	Interactions at Home PINX	7.8.1.1	c.1	[]	o: Yes [] No []

c.1: if E1 and A2 then optional, else N/A

A.4.8 Interactions between ANF-PUMO and Call Diversion

Item	Question / feature	References	Status	N/A	Support
F1	Support of SS-CFU/CFB/CFNR/CD	ECMA-174	o		Yes [] No []
F2	Home PINX acts as Rerouting PINX	7.8.6.1	c.1	[]	o: Yes [] No []

c.1: if F1 and A2 then optional, else N/A

A.4.9 Interactions between ANF-PUMO and ANF-PR

Item	Question / feature	References	Status	N/A	Support
G1	Support of ANF-PR	ECMA-176	o		Yes [] No []
G2	Home PINX acts as Cooperating PINX	7.8.7.1	c.1	[]	o: Yes [] No []

c.1: if G1 and A2 then optional, else N/A

A.4.10 Interactions between ANF-PUMO and ANF-CINT

Item	Question / feature	References	Status	N/A	Support
H1	Support of ANF-CINT	ECMA-221	o		Yes [] No []
H2	Home PINX acts as Intercepting PINX	7.8.14.1	c.1	[]	o: Yes [] No []

c.1: if H1 and A2 then optional, else N/A

A.4.11 Interactions between ANF-PUMO and ANF-TC

Item	Question/feature	References	Status	N/A	Support
I1	Support of ANF-TC	ECMA-225	o		Yes [] No []
I2	Interactions at Home PINX	7.8.15.1	c.1	[]	o:Yes [] No []

c.1: if I1 and A2 then optional, else N/A

A.4.12 Interactions between ANF-PUMO and ANF-RRC

Item	Question/feature	References	Status	N/A	Support
J1	Support of ANF-RRC	ISO/IEC 13241	o		Yes [] No []
J2	Interactions at Home PINX	7.8.16.1	c.1	[]	o:Yes [] No []

c.1: if J1 and A2 then optional, else N/A

Annex B
(informative)

Imported ASN.1 definitions



The content of this annex has been deleted to remove duplicate ASN.1 definitions defined elsewhere.

Annex C (informative)

Examples of Message Sequences

This annex describes some typical message flows for ANF-PUMI and ANF-PUMO. The following conventions are used in the figures of this annex:

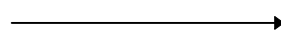
1. The following notation is used:

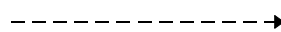
	Basic call message containing ANF-PUMI / ANF-PUMO information
	Basic call message without ANF-PUMI / ANF-PUMO information
	Call independent signalling connection message containing ANF-PUMI information
	Call independent signalling connection message without ANF-PUMI information
xxx.inv	Invoke APDU for operation xxx
xxx.res	Return result APDU for operation xxx
xxx.err	Return error APDU for operation xxx

2. The figures show messages exchanged via Protocol Control between PINXs involved in ANF-PUMI / ANF-PUMO. Only messages relevant to ANF-PUMI / ANF-PUMO are shown.
3. Only the relevant information content (e.g. remote operation APDUs, notifications, information elements) is listed below each message name. The Facility information elements containing remote operation APDUs are not explicitly shown. Information with no impact on ANF-PUMI / ANF-PUMO is not shown.

C.1 Example message sequences for normal operation of ANF-PUMI

Figure C.1 shows an example of normal operation of ANF-PUMI.

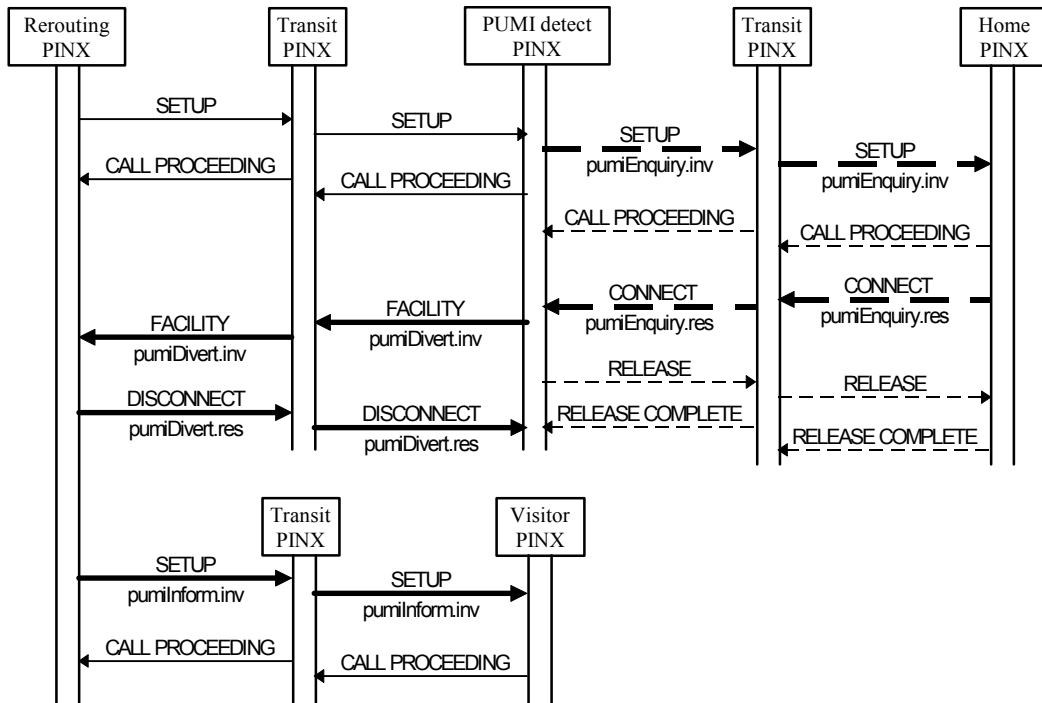

Figure C.1 - Example of normal operation of ANF-PUMI

Figure C.2 shows an example of ANF-PUMI when the Rerouting fails and the PUMI-detect PINX performs forward switching to the Visitor PINX.

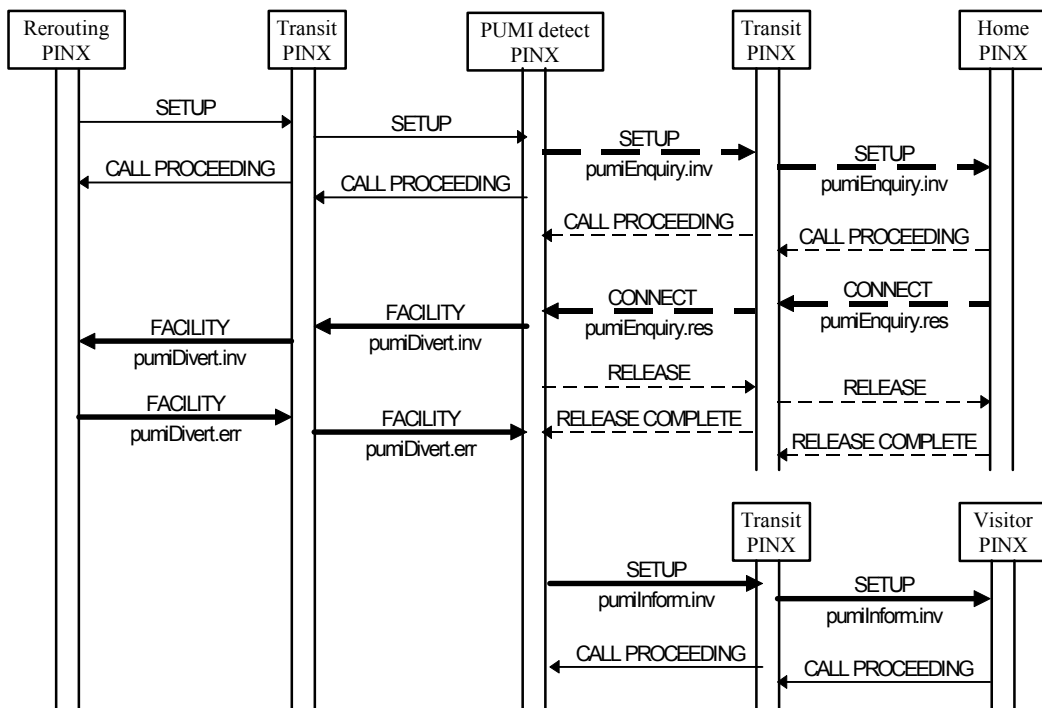

Figure C.2 - Example of forward switching by the PUMI-detect PINX

C.2 Examples of unsuccessful operation of ANF-PUMI

C.2.1 PUM user unknown in Home PINX

Figure C.3 shows an example of unsuccessful operation of ANF-PUMI due to PUM user unknown.

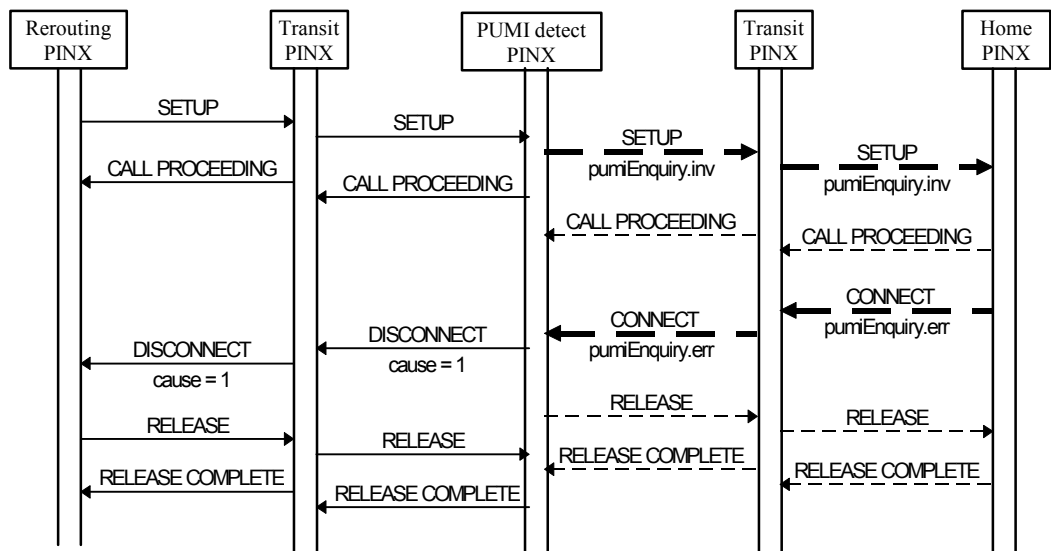

Figure C.3 - Example of ANF-PUMI failure due to PUM user unknown

C.2.2 PUM user has de-registered

Figure C.4 shows an example of unsuccessful operation of ANF-PUMI due to the PUM user having de-registered.

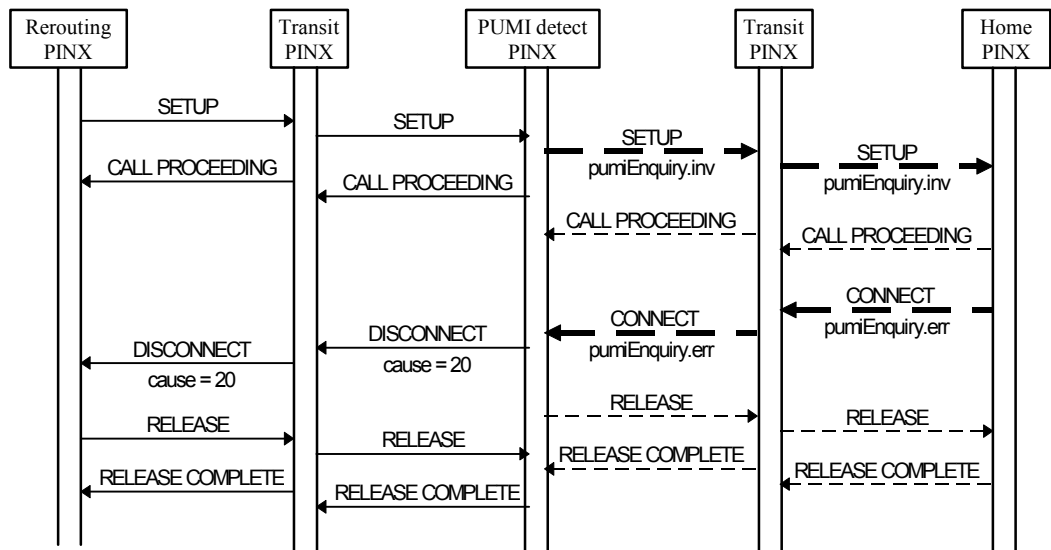

Figure C.4 - Example of ANF-PUMI failure due to PUM user having de-registered

C.2.3 Collision with location update detected by Visitor PINX

Figure C.5 shows an example of unsuccessful operation of ANF-PUMI due to collision with location update.

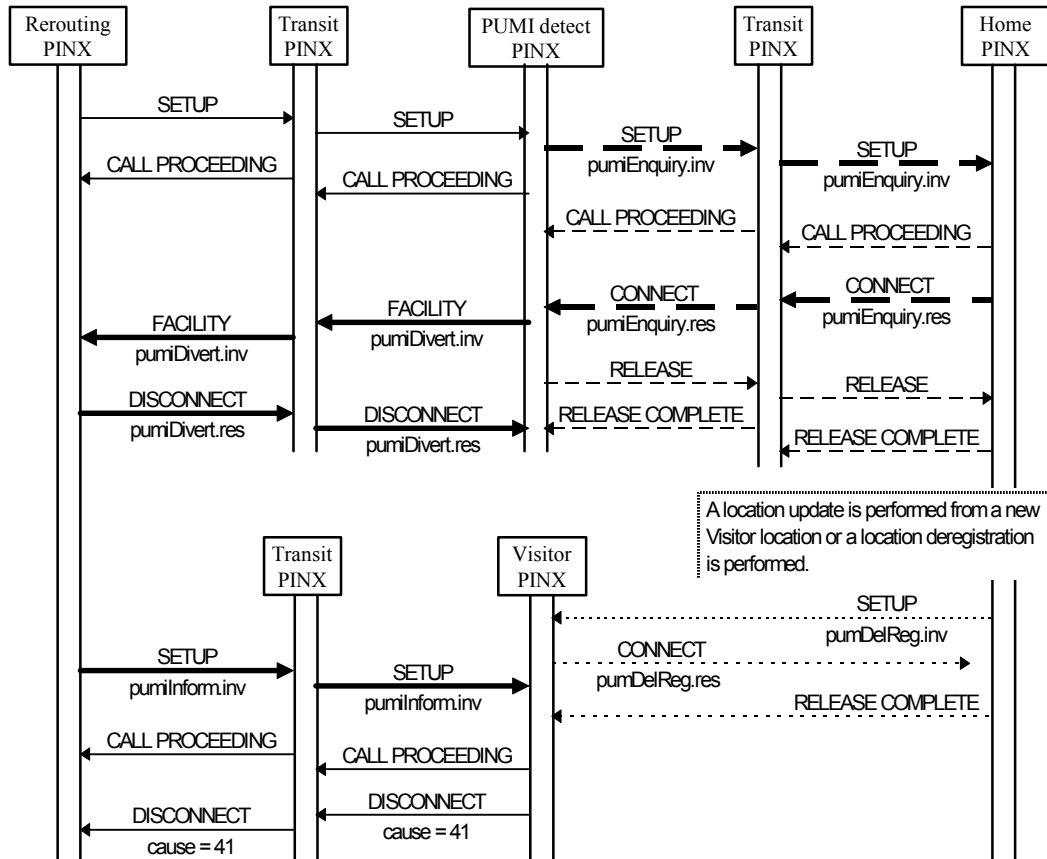

Figure C.5 - Example of ANF-PUMI failure due to collision with location update

C.3 Successful invocation of ANF-PUMO

C.3.1 With overlap operation

Figure C.6 shows an example of the invocation of ANF-PUMO where the destination number is sent in pieces.

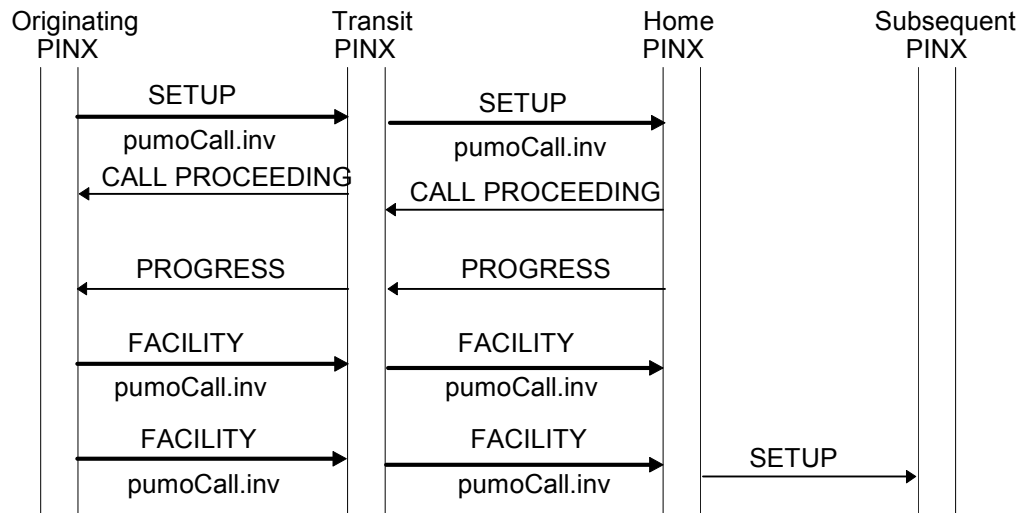

Figure C.6 - Successful invocation of ANF-PUMO with overlap operation

C.3.2 With en-bloc operation

Figure C.7 shows an example of the invocation of ANF-PUMO where the whole destination number is sent in the first message.

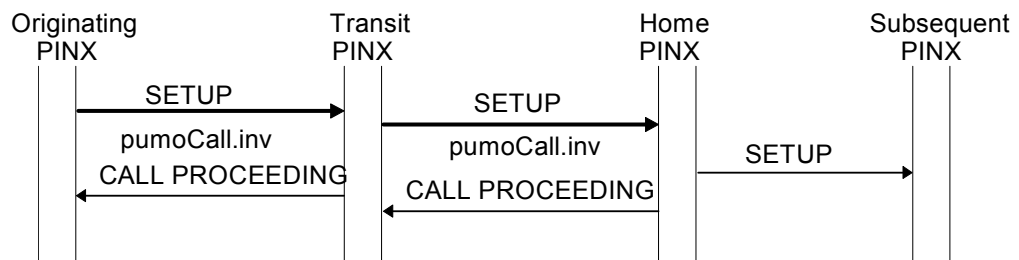

Figure C.7 - Successful invocation of ANF-PUMO with en-bloc operation

Annex D
(informative)

Specification and Description Language (SDL) representation of procedures

The diagrams in this annex use the Specification and Description Language defined in ITU-T Recommendation Z.100.

Each diagram represents the behaviour of an ANF-PUMI / ANF-PUMO Service Control entity at a particular type of PINX. In accordance with the protocol model described in ECMA-165, the Supplementary Service Control entity uses, via the Coordination function, the services of Generic Functional Procedures Control and Basic Call Control.

Where an output symbol represents a primitive to the Coordination function, and that primitive results in a message being sent, the output symbol bears the name of the message and any remote operations APDU(s) contained in that message. In the case of a message specified in ECMA-143, basic call actions associated with the sending of that message are deemed to occur.

Where an input symbol represents a primitive from the Coordination function, and that primitive is the result of a message being received, the input signal bears the name of the message and any remote operations APDU(s) contained in that message. In the case of a message specified in ECMA-143, basic call actions associated with the receipt of that message are deemed to have occurred.

The following abbreviations are used:

inv	Invoke APDU
res	Return result APDU
err	Return error APDU
rej	Reject APDU

D.1 SDL representation of ANF-PUMI at the Rerouteing PINX

Figure D.1 shows the behaviour of an ANF-PUMI Supplementary Service Control entity within the Rerouteing PINX.

Input signals from the right and output signals to the right represent primitives to and from the Co-ordination Function in respect of messages sent and received.

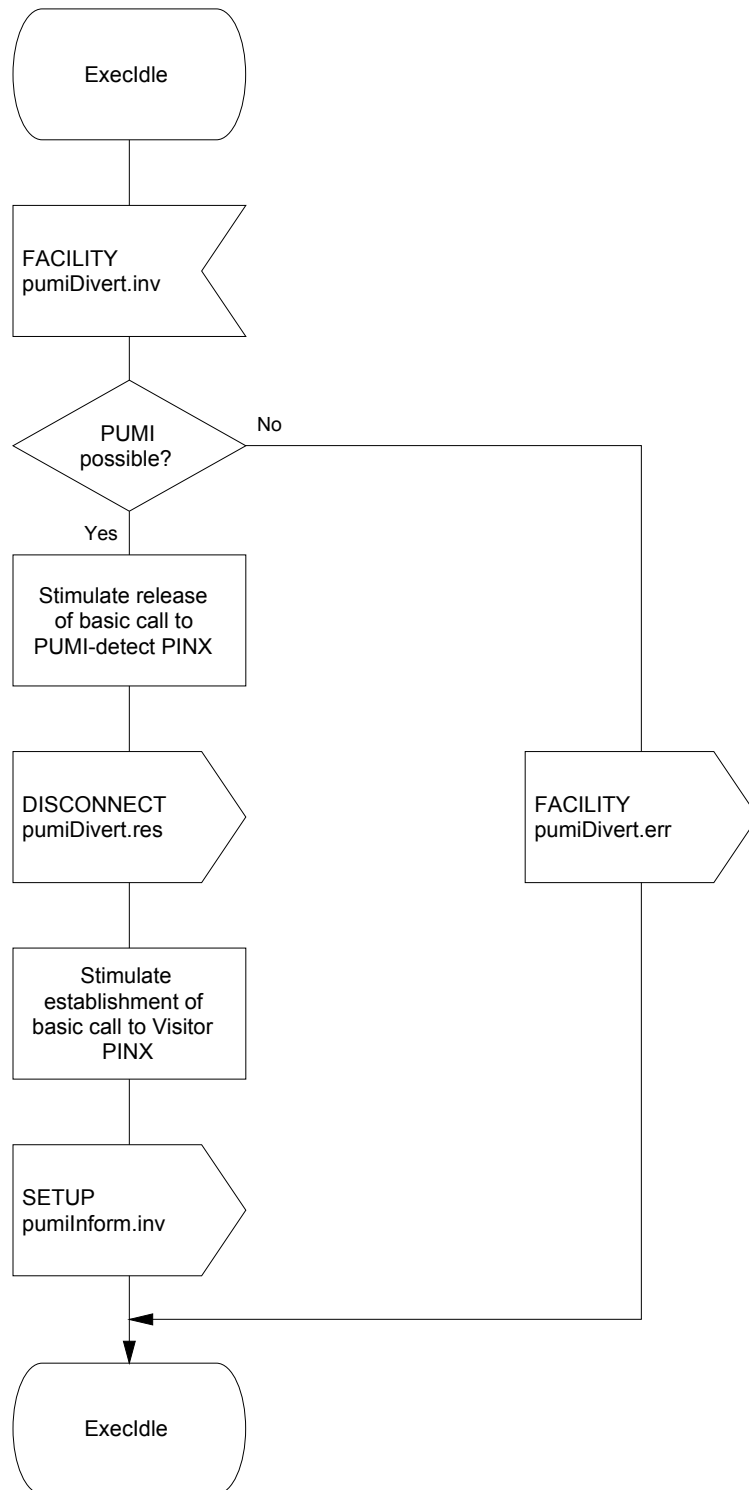

Figure D.1 - SDL representation of ANF-PUMI at the Rerouteing PINX

D.2 SDL representation of ANF-PUMI at the PUMI-detect PINX

Figure D.2 shows the behaviour of an ANF-PUMI entity within the PUMI-detect PINX.

Input signals from the right and output signals to the right represent primitives to and from the Co-ordination Function in respect of messages sent and received. Also protocol timer expiry is indicated by an input signal from the right.

Input signals from the left represent internal stimuli.

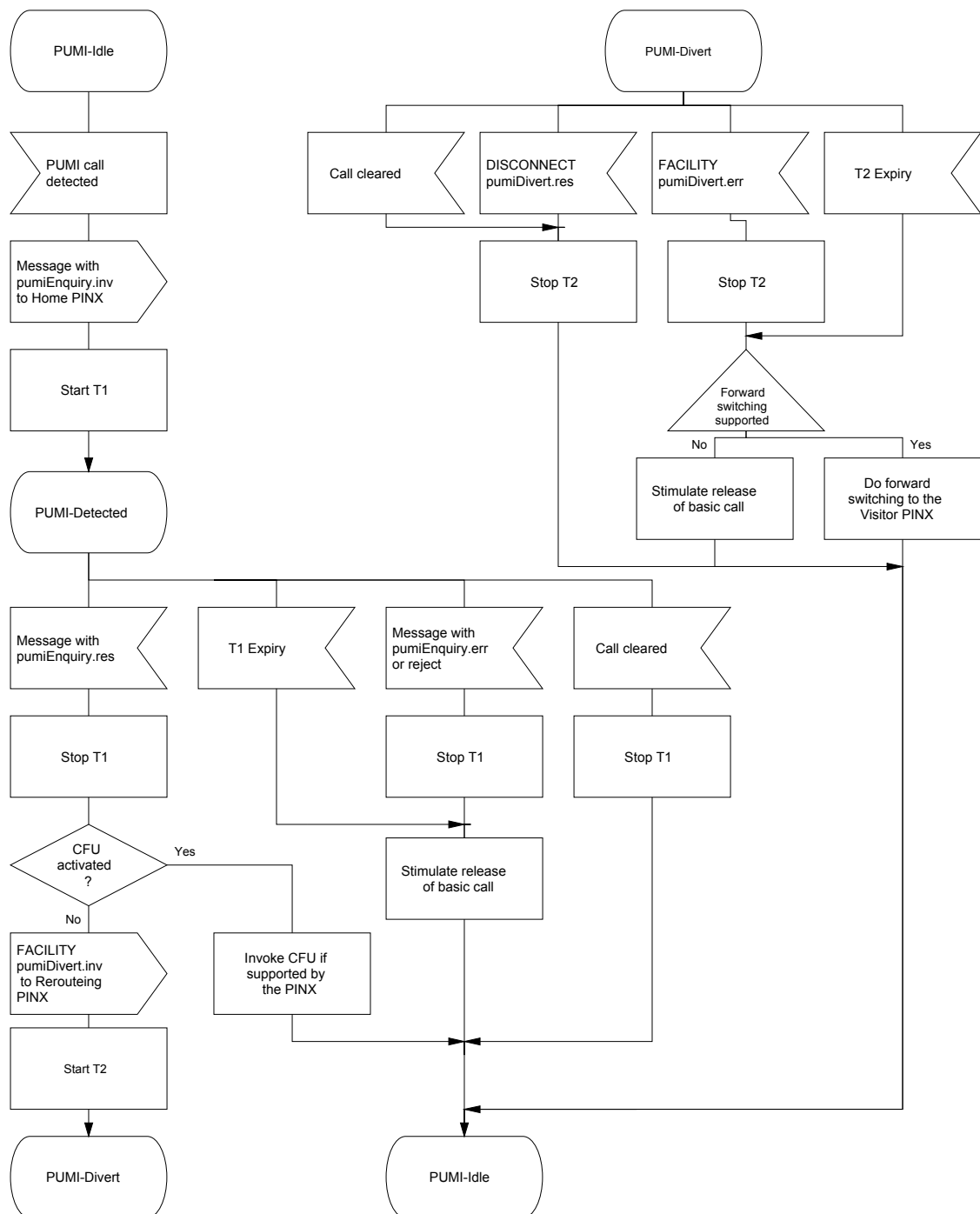

Figure D.2 - SDL representation of ANF-PUMI at the PUMI-detect PINX

D.3 SDL representation of ANF-PUMI at the Home PINX

Figure D.3 shows the behaviour of an ANF-PUMI entity within the Home PINX.

Input signals from the right and output signals to the right represent primitives to and from the Co-ordination Function in respect of messages sent and received.

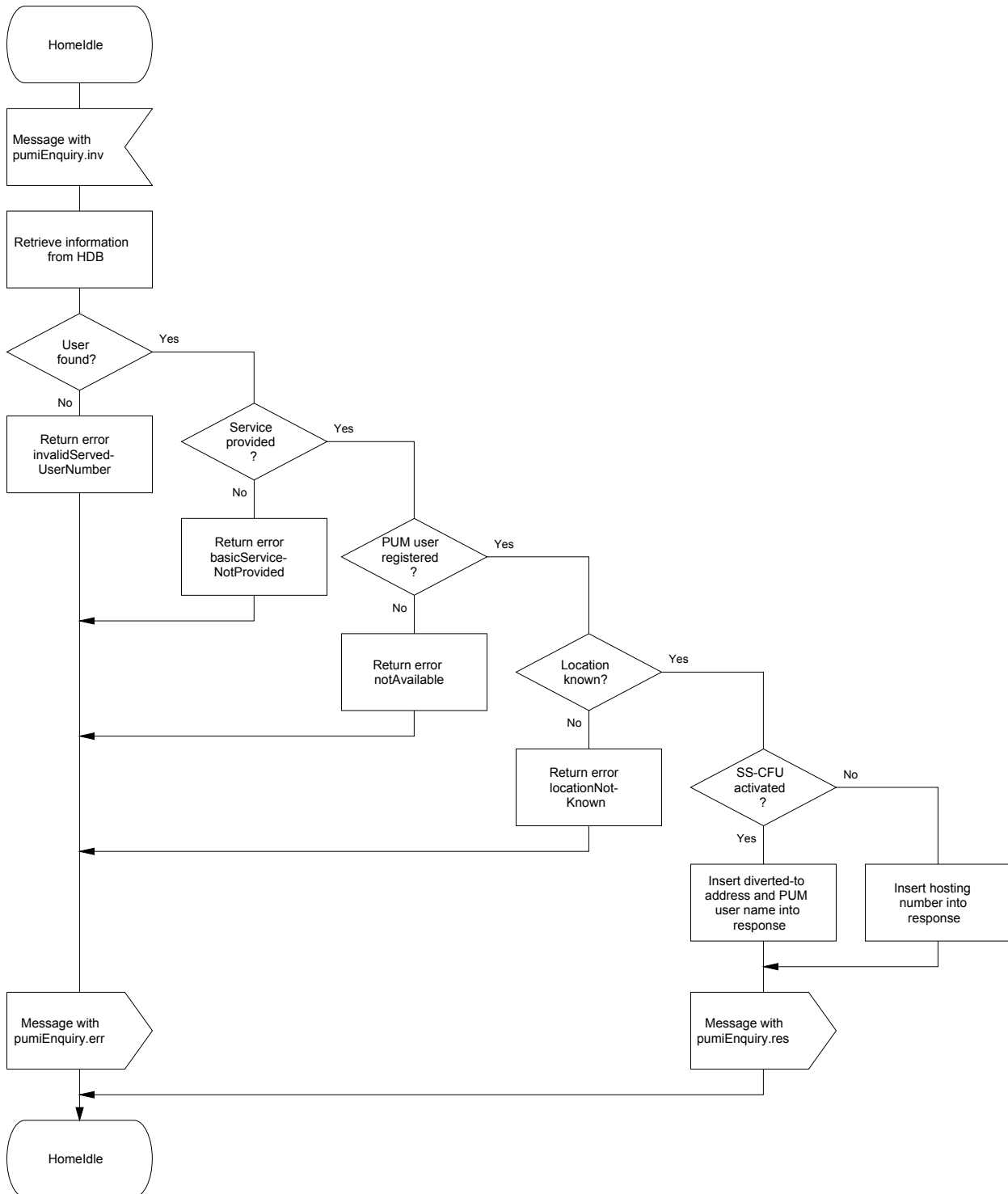

Figure D.3 - SDL representation of ANF-PUMI at the Home PINX

D.4 SDL representation of ANF-PUMI at the Visitor PINX

Figure D.4 shows the behaviour of an ANF-PUMI entity within the Visitor PINX.

Input signals from the right and output signals to the right represent primitives to and from the Co-ordination Function in respect of messages sent and received.

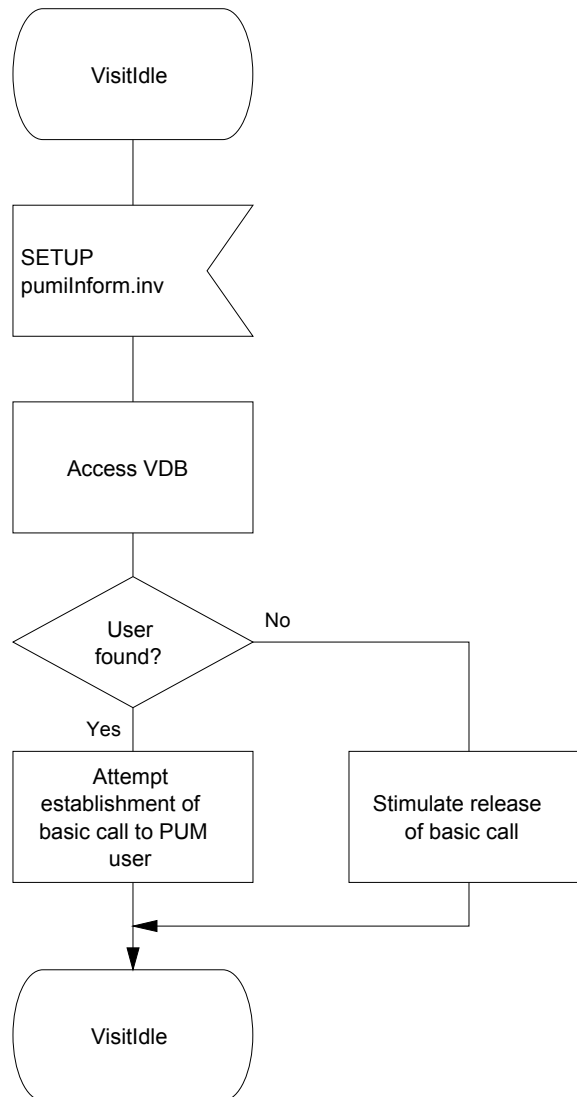

Figure D.4 - SDL representation of ANF-PUMI at the Visitor PINX

D.5 Behaviour of the Originating PINX for ANF-PUMO

Figure D.5 shows the behaviour of the Originating PINX.

Input signals from the left represent internal primitives. Output signals to the right represent messages to the peer SS-Control entity (i.e. in the Home PINX).

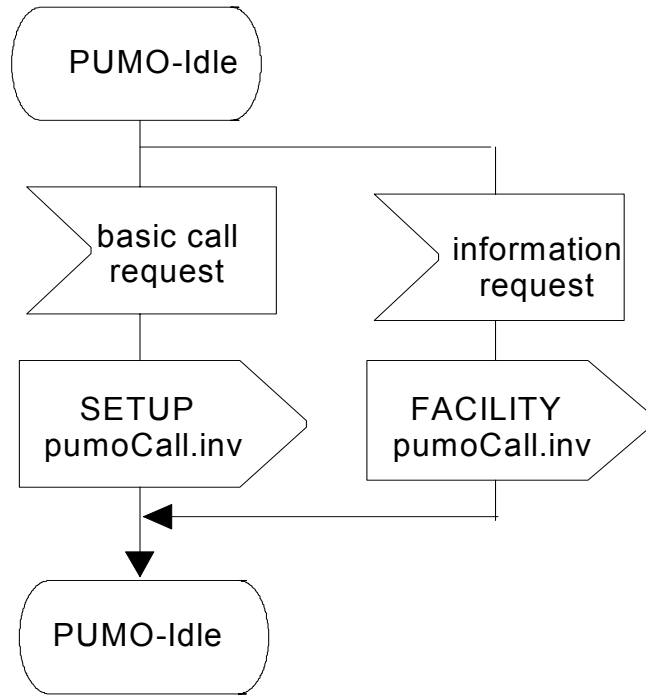

Figure D.5 - Originating PINX behaviour

D.6 Behaviour of the Home PINX for ANF-PUMO

Figures D.6 and D.7 show the behaviour of the Home PINX.

Input signals from the left represent messages from the peer SS-Control entity (i.e. in the Originating PINX). Output signals to the right and input signals from the right represent internal primitives.

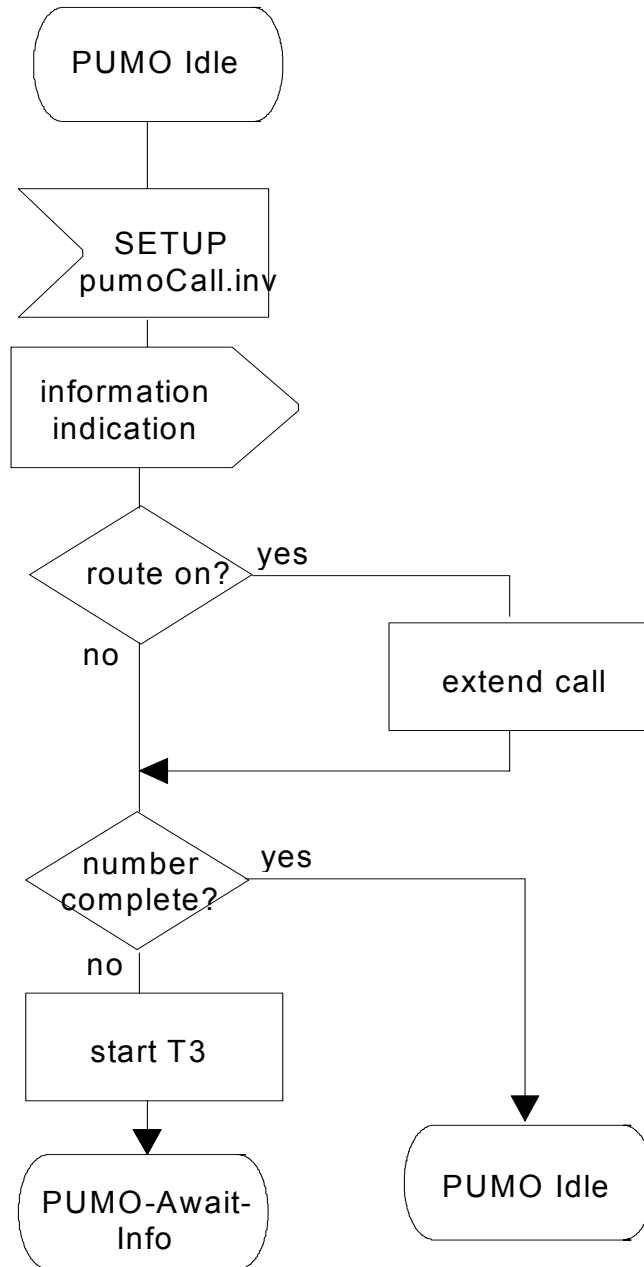

Figure D.6 - Home PINX behaviour (part 1)

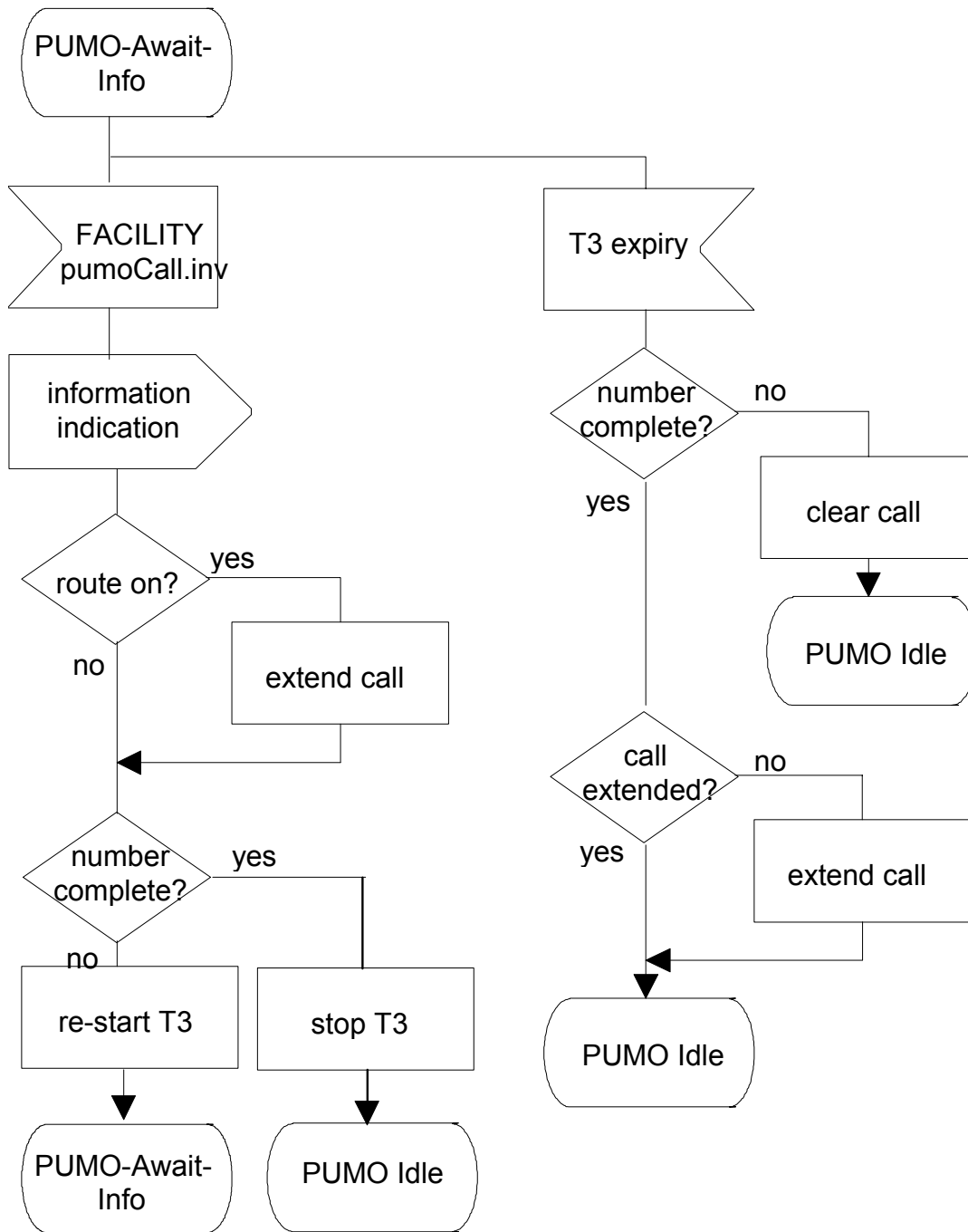

Figure D.7 - Home PINX behaviour (part 2)

Annex E
(normative)

Additional feature identifier in module Common-Information-Operations

In ASN.1 module Common-Information-Operations {iso (1) standard (0) pss1-common-information (15772) operations (0)}, specified in 6.3.1 of ECMA-251, bit number 16 of type **FeatureIdList** shall be interpreted in the following way:

anfPUMIreRoutingSupported	(16)	-- <i>Rerouting for -- Incoming PUM calls -- supported</i>
---------------------------	------	--------------------------------------------------------------------

Annex F
(normative)

ASN.1 definitions according to ITU-T Recs. X.208 / X.209

This annex lists all ASN.1 modules as they were defined in the second edition of ECMA-284, i.e. based on ITU-T Recommendations X.208 / X.209. Starting with the third edition the ASN.1 modules within ECMA-284 comply with ITU-T Recommendations X.680 / X.690. Please note that regardless of which version of these modules is used as a base of a QSIG implementation, the line encoding remains unchanged. Changes in future editions to modules based on X.680 / X.690 ASN.1 are not reflected in the modules in this annex.

Table F.1 - Private-User-Mobility-Call-Handling-Operations – based on ITU-T Recs. X.208 / X.209

```
Private-User-Mobility-Call-Handling-Operations
{ iso (1) standard (0) pss1-pum-call-handling (17878) pum-call-handling-operations (0) }

DEFINITIONS EXPLICIT TAGS ::=

BEGIN

IMPORTS
    OPERATION, ERROR FROM Remote-Operation-Notation
        { joint-iso-ccitt (2) remote-operations (4) notation (0) }
    Extension FROM Manufacturer-specific-service-extension-definition
        { iso (1) standard (0)
          pss1-generic-procedures (11582) msi-definition (0) }
    PSS1InformationElement FROM Generic-parameters-definition
        { iso (1) standard (0)
          pss1-generic-procedures (11582) pss1-generic-parameters (6) }
    Name FROM Name-Operations
        { iso (1) standard (0)
          pss1-name (13868) name-operations (0) }
    basicServiceNotProvided, invalidServedUserNumber, notAvailable FROM
        General-Error-List
        { ccitt (0) recommendation (0) q (17) 950 general-error-list (1) }
    Address, PartyNumber, PartySubaddress, PresentedNumberScreened FROM
        Addressing-Data-Elements
        { iso (1) standard (0) pss1-generic-procedures (11582)
          addressing-data-elements (9) };

-- Operations for ANF-PUMI: --
PumiEnquiry ::=
    OPERATION
        -- Sent from the PUMI-detect PINX to the Home PINX.
    ARGUMENT    EnquiryArg
    RESULT      EnquiryRes
    ERRORS      { invalidServedUserNumber, locationNotKnown,
                 notAvailable, basicServiceNotProvided, unspecified }

PumiDivert ::=
    OPERATION
        -- Sent from the PUMI-detect PINX to the Rerouting PINX.
    ARGUMENT    DivertArg
    RESULT      DummyRes
    ERRORS      { notAvailable, unspecified }
```

Table F.1 - Private-User-Mobility-Call-Handling-Operations – based on ITU-T Recs. X.208 / X.209 (continued)

PumInform ::=	OPERATION	
	-- Sent from the Rerouteing PINX to the Visitor PINX.	
	ARGUMENT	InformArg
EnquiryArg ::=	SEQUENCE	{ pisinNumber PartyNumber, -- The PISN number of the PUM user qSIGInfoElement PSS1InformationElement, -- The basic call information elements Bearer capability, High layer compatibility, -- Low layer compatibility can be embedded in the qSIGInfoElement -- in accordance with clause 6.5.2.1. argExtension PumiExtension OPTIONAL }
DivertArg ::=	SEQUENCE	{ hostingAddr PartyNumber, -- The PISN number of the hosting user, -- always a Complete Number. callingNumber PresentedNumberScreened, pumIdentity PumIdentity, -- The PISN number (always a Complete Number) -- and/or an alternative identifier of the PUM user. qSIGInfoElement PSS1InformationElement, -- The basic call information elements Bearer capability, High layer compatibility, -- Low layer compatibility, and Progress indicator -- can be embedded in the qSIGInfoElement in accordance with clause 6.5.2.1. callingUserSub [1] PartySubaddress OPTIONAL, callingUserName [2] Name OPTIONAL, pumUserSub [3] PartySubaddress OPTIONAL, argExtension PumiExtension OPTIONAL }
InformArg ::=	SEQUENCE	{ pumIdentity PumIdentity, -- The PISN number (always a Complete Number) -- and/or an alternative identifier of the PUM user. argExtension PumiExtension OPTIONAL }
EnquiryRes ::=	CHOICE	{ currLocation [1] IMPLICIT CurrLocation, cfuActivated [2] IMPLICIT CfuActivated }
CurrLocation ::=	SEQUENCE	{ hostingAddr PartyNumber, -- The PISN number of the hosting user, -- always a Complete Number. pumIdentity PumIdentity, -- The PISN number (always a Complete Number) -- and/or an alternative identifier of the PUM user. argExtension PumiExtension OPTIONAL }
CfuActivated ::=	SEQUENCE	{ divToAddress Address, divOptions SubscriptionOption, pumName [1] Name OPTIONAL, argExtension PumiExtension OPTIONAL }
SubscriptionOption ::=	ENUMERATED	{ noNotification (0), notificationWithoutDivertedToNr (1), notificationWithDivertedToNr (2) }
DummyRes ::=	CHOICE	{ null NULL, extension [1] IMPLICIT Extension, sequOfExtn [2] IMPLICIT SEQUENCE OF Extension }
PumiExtension ::=	CHOICE	{ extension [4] IMPLICIT Extension, sequOfExtn [5] IMPLICIT SEQUENCE OF Extension }

Table F.1 - Private-User-Mobility-Call-Handling-Operations – based on ITU-T Recs. X.208 / X.209 (concluded)

PumIdentity ::=	CHOICE	{ pisinNumber PartyNumber, alternativeld [10] IMPLICIT Alternativeld, both [11] IMPLICIT SEQUENCE { pisinNumber PartyNumber, alternativeld Alternativeld } }
Alternativeld ::=	OCTET STRING(SIZE(1..20))	
<i>-- Operation for ANF-PUMO --</i>		
PumoCall ::=	OPERATION ARGUMENT	PumoArg
PumoArg ::=	SEQUENCE	{ destinationNumber [0] PartyNumber OPTIONAL, pumIdentity [1] PumIdentity OPTIONAL, <i>-- The PISN number (always a Complete Number)</i> <i>-- and/or an alternative identifier of the PUM user.</i> sendingComplete [2] IMPLICIT NULL OPTIONAL, extension CHOICE {single [3] IMPLICIT Extension, multiple [4] IMPLICIT SEQUENCE OF Extension } OPTIONAL }
pumiEnquiry	PumiEnquiry	::= localValue 93
pumiDivert	PumiDivert	::= localValue 94
pumiInform	PumiInform	::= localValue 95
pumoCall	PumoCall	::= localValue 96
locationNotKnown	ERROR	::= localValue 1015
unspecified	Unspecified	::= localValue 1008
Unspecified		::= ERROR PARAMETER Extension
END	<i>-- of Private-User-Mobility-Call-Handling-Operations</i>	

Free printed copies can be ordered from:

ECMA

114 Rue du Rhône

CH-1204 Geneva

Switzerland

Fax: +41 22 849.60.01

Email: documents@ecma.ch

Files of this Standard can be freely downloaded from the ECMA web site (www.ecma.ch). This site gives full information on ECMA, ECMA activities, ECMA Standards and Technical Reports.

ECMA
114 Rue du Rhône
CH-1204 Geneva
Switzerland

See inside cover page for obtaining further soft or hard copies.