

**Constant Sound Power
Fan Curves for Small
Air-moving Devices**

Technical
Report



is the registered trademark of Ecma International



COPYRIGHT PROTECTED DOCUMENT

Contents		Page
1	Scope	1
2	References	1
3	Terms and definitions	1
4	Abbreviations.....	1
5	Iso-acoustic fan curves.....	2
5.1	Overview.....	2
5.2	Airflow chamber testing.....	2
5.3	Acoustic plenum testing.....	2
5.4	Flow rate determination	3
5.5	Iso-acoustic fan curve determination.....	7
5.6	Comparison to manual iso-acoustic data	9
5.7	Iso-acoustic fan curve test report.....	10
6	Inlet restriction fixture.....	11
6.1	Overview.....	11
6.2	Notebook inlet restriction fixture.....	11
6.3	Comparison to in-system noise.....	13
6.4	Iso-acoustic fan curve test report with inlet restriction fixture	14
Annex A (informative) Sample Data		15



Introduction

Fan performance in terms of flow and pressure can be measured using an airflow chamber in accordance with AMCA 210, and such a fan curve is normally provided in a manufacturer's datasheet. The datasheet may also contain a measured sound pressure level, typically at 1 m from the fan inlet, with the fan in free space. Sound power level in a loaded condition, as a function of static pressure, may be measured in accordance with ISO 10302-1 by using an acoustic fan plenum. Such data is much more indicative of the noise the fan will make when installed in a device, but is difficult to compare to the fan curve without cross-plotting between multiple data sets. A simpler way to comprehensively state fan performance is with a constant sound power, or iso-acoustic, fan curve. Using this iso-acoustic fan curve, fan performance may be easily compared in terms of flow, pressure, and noise. For example, iso-acoustic fan curves for two fans at the same sound power level may be compared to the impedance curve of a system to determine which fan will provide more airflow in that system for a fixed acoustic limit. Alternately, if a sound power level is chosen for the iso-acoustic fan curve that is acceptable from an ergonomics perspective, the system designer can be confident that the acoustic limit will automatically be satisfied no matter what the system impedance turns out to be in the final design.

Inlet effects can have a large impact on fan flow rate and noise generation. For example, an axial fan commonly has a finger guard or grille, while a blower used in a notebook computer operates within a very constrained space. Since these effects cannot be accounted for by a simple pressure drop due to the complicated flow physics, it is desirable that the fan curve for a specific application include such inlet losses directly. A fixture to approximate the inlet restriction in a notebook computer is described that has been shown to correlate closely with the noise of actual systems.

This Ecma Technical Report has been adopted by the General Assembly of December 2010.

"DISCLAIMER

This document and possible translations of it may be copied and furnished to others, and derivative works that comment on or otherwise explain it or assist in its implementation may be prepared, copied, published, and distributed, in whole or in part, without restriction of any kind, provided that the above copyright notice and this section are included on all such copies and derivative works. However, this document itself may not be modified in any way, including by removing the copyright notice or references to Ecma International, except as needed for the purpose of developing any document or deliverable produced by Ecma International (in which case the rules applied to copyrights must be followed) or as required to translate it into languages other than English.

The limited permissions granted above are perpetual and will not be revoked by Ecma International or its successors or assigns.

This document and the information contained herein is provided on an "AS IS" basis and ECMA INTERNATIONAL DISCLAIMS ALL WARRANTIES, EXPRESS OR IMPLIED, INCLUDING BUT NOT LIMITED TO ANY WARRANTY THAT THE USE OF THE INFORMATION HEREIN WILL NOT INFRINGE ANY OWNERSHIP RIGHTS OR ANY IMPLIED WARRANTIES OF MERCHANTABILITY OR FITNESS FOR A PARTICULAR PURPOSE."

Constant Sound Power Fan Curves for Small Air-moving Devices

1 Scope

This Ecma Technical Report specifies a method to generate iso-acoustic fan curves for small air-moving devices, with or without the presence of a fixture to provide a specific inlet condition to the unit under test. A fixture to provide inlet restriction applicable to blowers used in cooling of notebook computers is also described. It is assumed that users are familiar with aerodynamic fan performance measurements and the use of the acoustic fan plenum to measure sound power of a fan under load.

2 References

For dated references, only the edition cited applies. For undated references, the latest edition of the referenced document (including any amendments) applies.

ISO 10302-1, *Acoustics - Measurement of Noise and Vibration of Small Air-Moving Devices, Part 1: Airborne Noise Emission*

AMCA 210, *Laboratory Methods of Testing Fans for Aerodynamic Performance Rating*

3 Terms and definitions

For the purposes of this document, the following terms and definitions apply.

3.1

iso-acoustic fan curve

relation between pressure and flow performance of a fan along an isobel

3.2

isobel

contour of constant sound power level

3.3

airflow chamber

device used to measure the flow and pressure performance of an air-moving device

4 Abbreviations

AFC Airflow Chamber

RPM Revolutions Per Minute

5 Iso-acoustic fan curves

5.1 Overview

The iso-acoustic fan curve procedure applies to any air-moving device measured on the acoustic plenum. The term “fan” will be used generically to describe the air-moving device. Two measurements must be combined to generate the iso-acoustic curve, one data set from an airflow chamber (AFC) and one data set from an acoustic plenum. The AFC data comprises at least one constant voltage fan curve. The acoustic plenum data comprises a set of measurements spanning a wide range of operating points. The AFC data is used to determine the flow rate for each acoustic plenum measurement by an interpolation technique. The flow, pressure, and noise data is then scaled, using a chosen exponent, to a desired sound power target and a final fitting function generated to describe the iso-acoustic curve.

NOTE If an inlet restriction fixture is used (see Clause 6), it should be used for both the AFC and acoustic plenum testing.

5.2 Airflow chamber testing

The minimum requirement is to measure at least one constant voltage fan curve, recording at least flow, pressure, and fan speed data. The recommended procedure is to measure at two voltages (60% and 100% of the rated voltage) with at least eight points on each fan curve. An example data set is shown in Figure 1.

Once installed on the AFC, it is estimated that each data point should take one minute to collect.

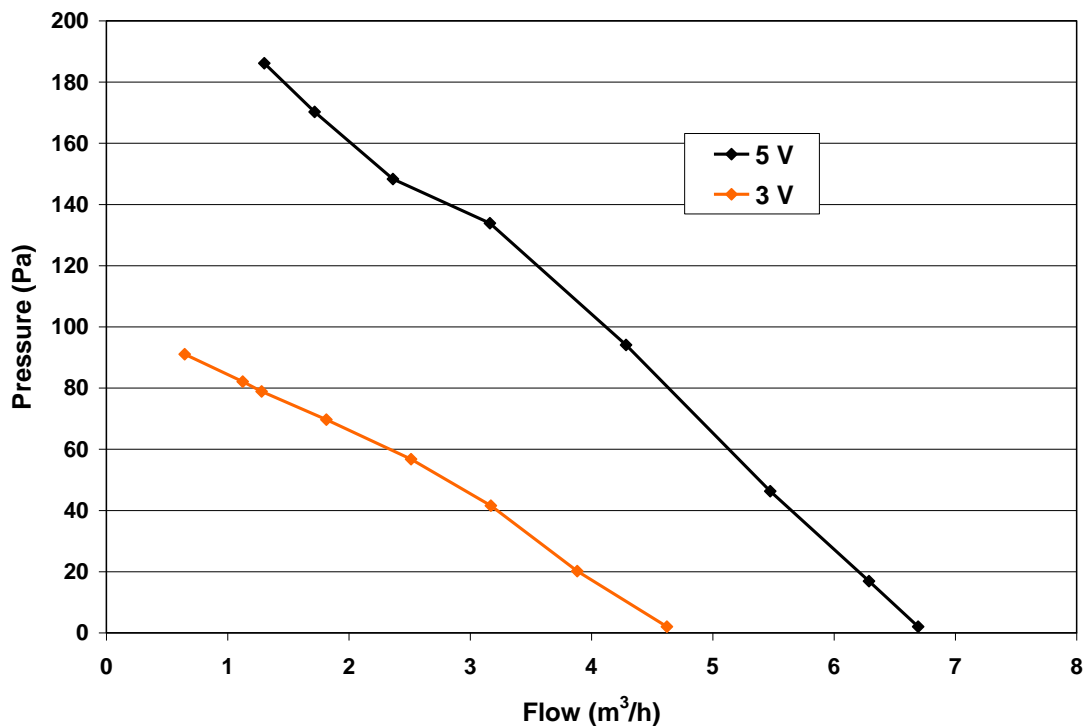

Figure 1 — Constant voltage fan curves (Q_v, P_v)

5.3 Acoustic plenum testing

The acoustic plenum data should span a wide range of operating points, from maximum flow to near stagnation pressure, at a minimum of two voltages. The exact voltages and pressure values are not important; no effort should be spent to match any operating point measured in 5.2. The minimum requirement is to measure five operating points at each of two voltages, recording A-weighted sound power level, plenum

pressure, and fan speed. The recommended procedure is to measure at least six operating points for each of three voltages (60%, 80%, and 100% of the rated voltage). An example data set is shown in Figure 2.

Once installed on the acoustic plenum, it is estimated that each data point should take one to two minutes to collect (longer if the slider on the plenum must be manually operated).

NOTE Due to plenum leakage, the maximum pressure on the acoustic plenum may be less than the stagnation pressure recorded on the AFC at the same voltage. If the maximum flow of the fan is less than twice the leakage rate of the plenum, the fan should be considered too small to measure using the plenum.

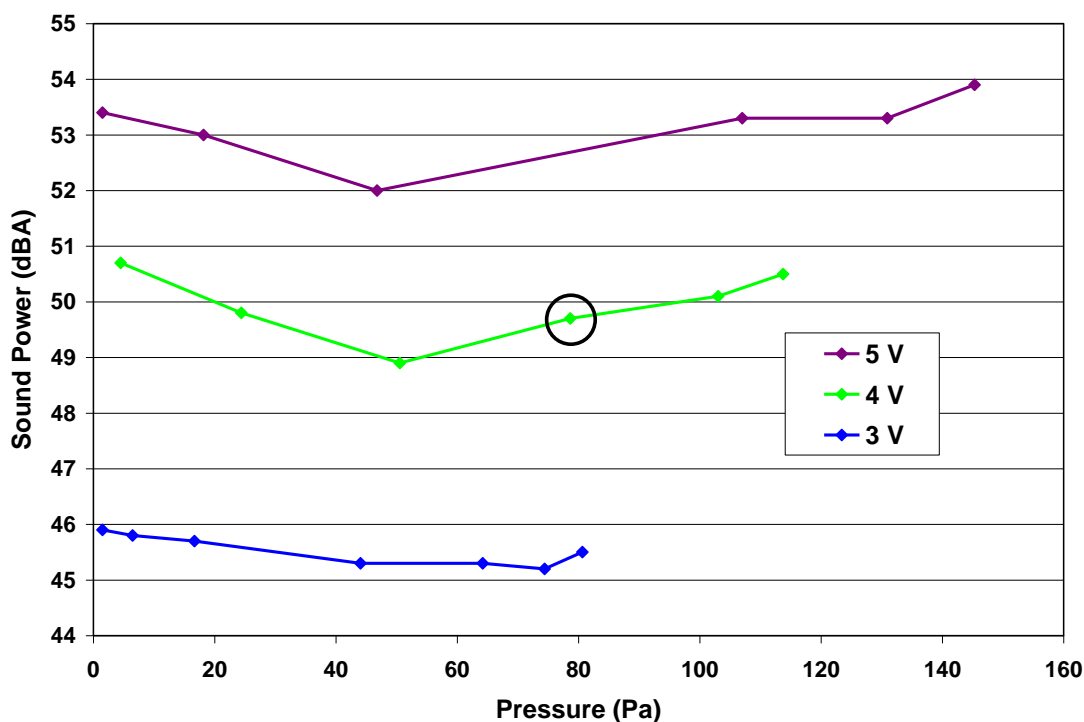

Figure 2 — Acoustic plenum data (L_{WP} , P_P)

NOTE Example point for which the flow rate is to be determined is circled. The fan speed is 6 304 RPM.

5.4 Flow rate determination

For each operating point measured in 5.3, such as the one circled in Figure 2, the flow rate on the acoustic plenum must be determined. Although this can be achieved by manually matching the fan speed and plenum pressure on the AFC, the recommended procedure is to interpolate based on the constant voltage data from 5.2.

For each acoustic plenum operating point, the fan speed N_P and plenum pressure P_P are known, while the flow rate Q_P is desired. First, all of the constant voltage fan speed N_V , AFC pressure P_V , and flow rate Q_V data points are scaled to N_P using the following equations, where subscript 'P' indicates measured plenum data, subscript 'V' indicates the constant voltage fan curve data, and subscript 'S' indicates the data is scaled to a constant speed:

$$Q_S = Q_V \left(\frac{N_P}{N_V} \right) \quad (1a)$$

$$P_s = P_v \left(\frac{N_p}{N_v} \right)^2 \tag{1b}$$

An example data set is shown in Figure 3, where each point is a (Q_s, P_s) pair for the same N_p , 6 304 RPM in this case, based on the data in Figure 1 and the fan speed for the indicated point in Figure 2. Second, the data in Figure 3 is then modified by swapping the horizontal and vertical axes, as shown in Figure 4, and a smoothing function applied.

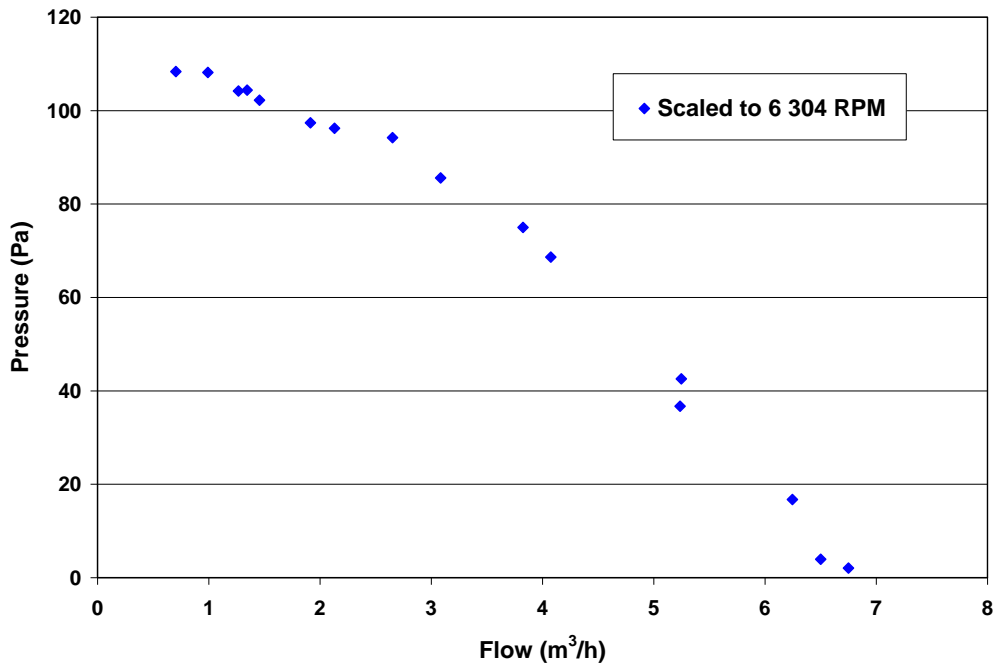

Figure 3 — Constant voltage data scaled to acoustic plenum fan speed (Q_s, P_s)

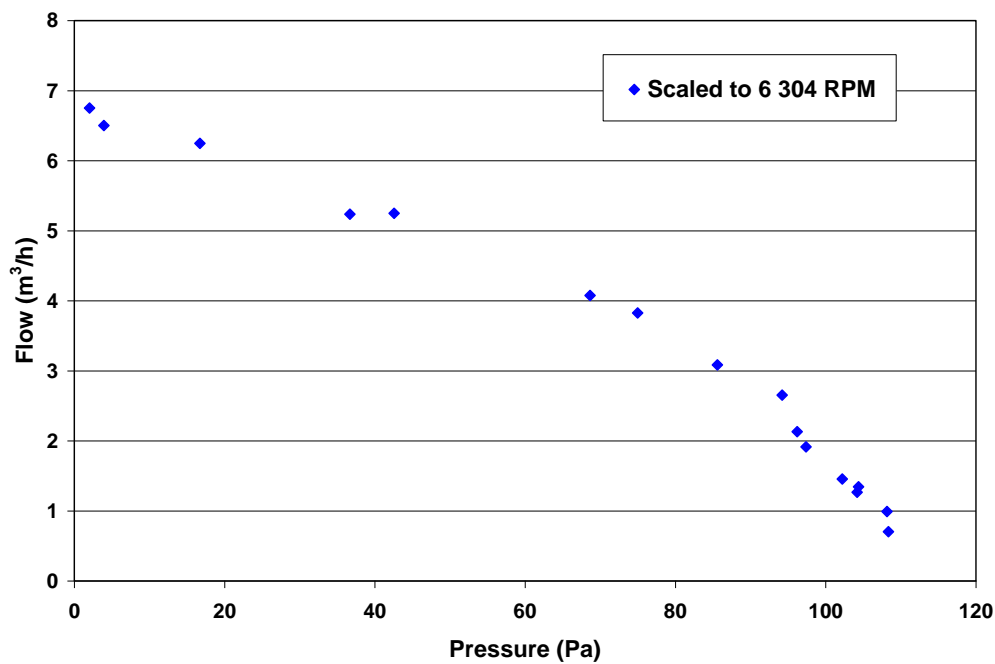

Figure 4 — Constant fan speed data with swapped axes (P_s, Q_s)

In order to make a smooth function out of the experimental data in Figure 4, a general polynomial least-squares regression is recommended. A spline is used here for demonstration. Engineering judgment must be used to select the stiffness of the spline. A good stiffness is shown in Figure 5, while an overly stiff spline is shown in Figure 6, and an overly flexible spline is shown in Figure 7.

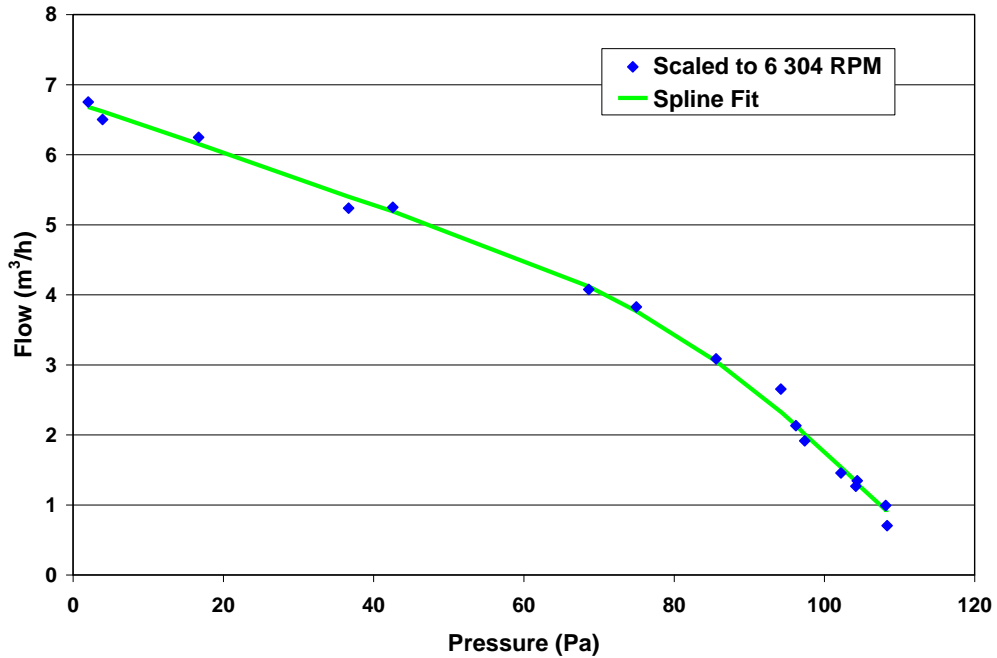

Figure 5 — Spline fit to constant fan speed data with swapped axes (P_s, Q_s)

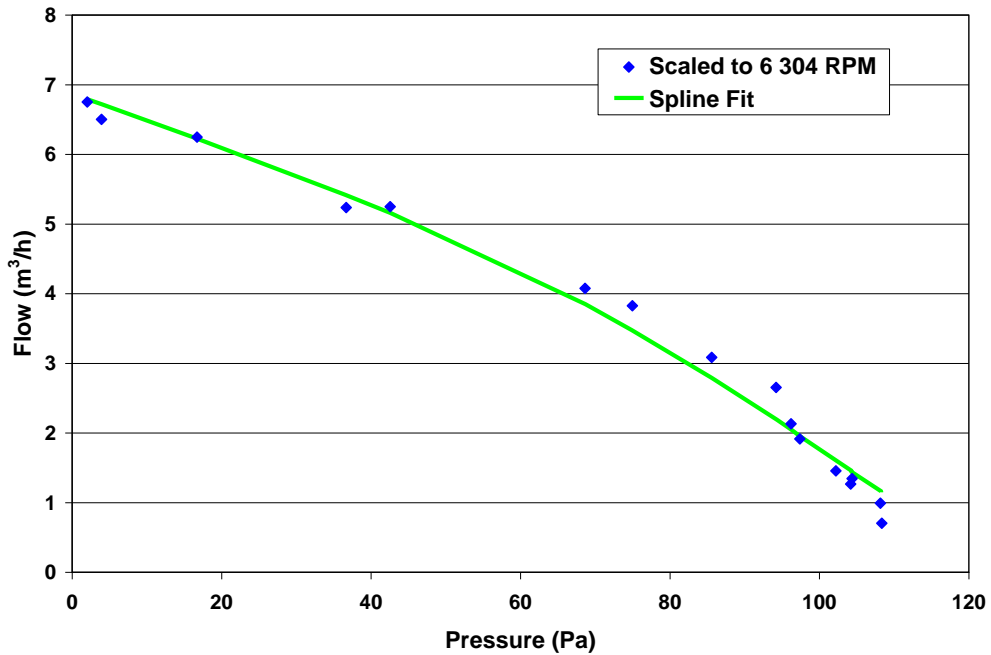

Figure 6 — Overly stiff spline

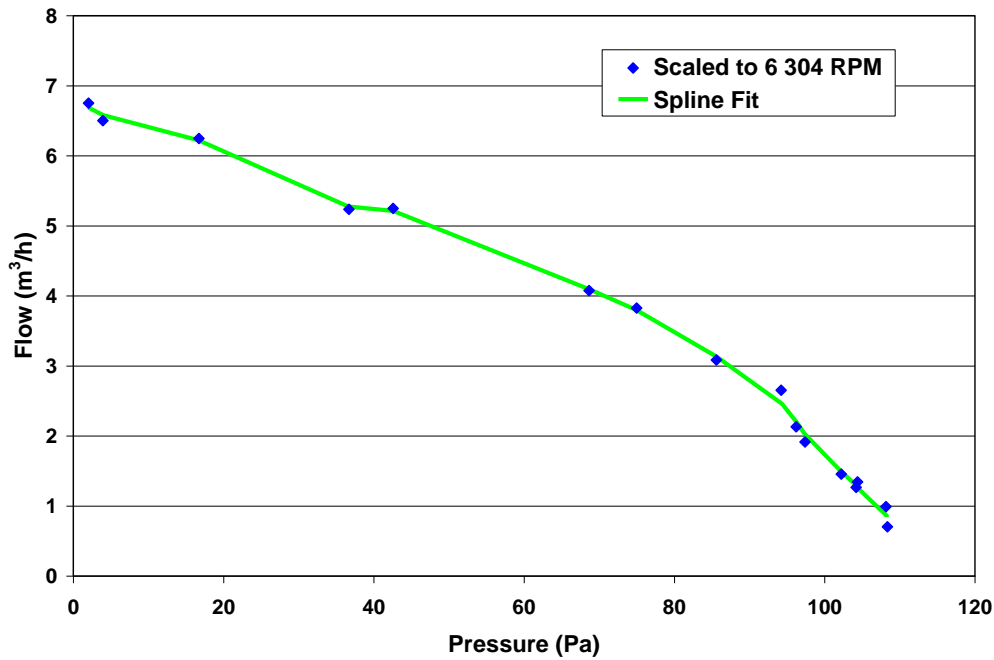

Figure 7 — Overly flexible spline

Third, once the spline fit is established, the desired flow rate Q_p is simply obtained by entering the known acoustic plenum pressure P_p and reading the corresponding flow rate from the spline. For example, as shown in Figure 8, for an N_p of 6 304 RPM and P_p of 78,6 Pa, corresponding to the circled point in Figure 2, the flow rate on the acoustic plenum Q_p is estimated to be 3,54 m³/h. This procedure is repeated for each operating point on the acoustic plenum in Figure 2.

Once implemented in software, the spline fit procedure to determine flow rate is extremely fast to execute; flow rates can be determined as quickly as fan speeds and pressure values can be entered.

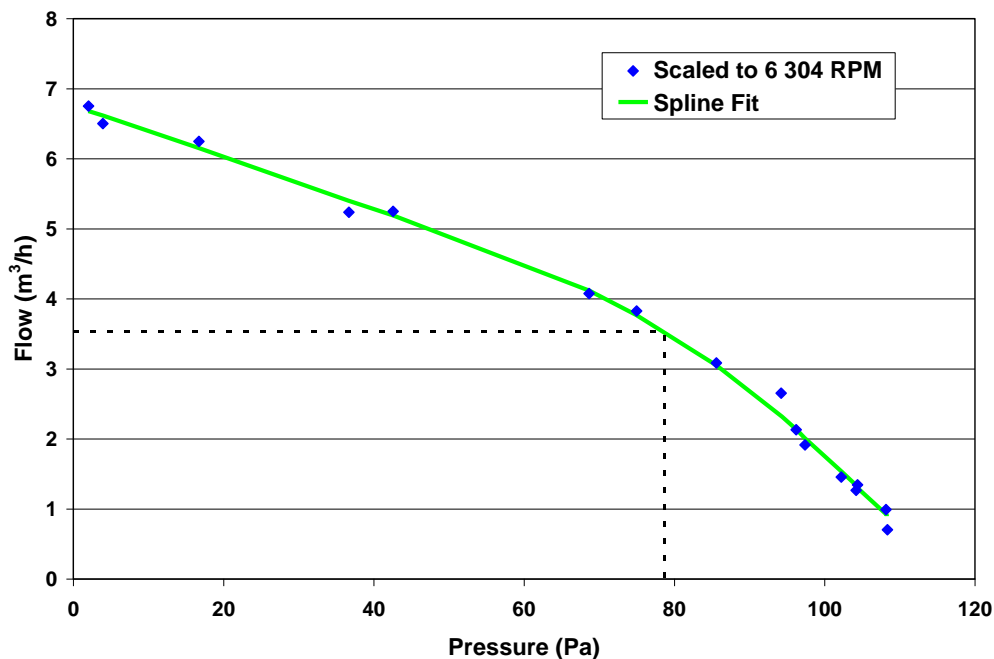

Figure 8 — Estimated flow rate for acoustic plenum at known fan speed and pressure

5.5 Iso-acoustic fan curve determination

After the procedure in 5.4 has been completed, the flow rate, plenum pressure, fan speed, and sound power values are all known for each operating point measured on the acoustic plenum according to 5.3. In order to scale this data to any desired constant sound power level, a new fan speed for each point is first determined, using the following equation, where a subscript 'P' indicates the original acoustic plenum data point and a subscript 'T' indicates the data point scaled to the desired sound power level target L_{WT} , in A-weighted decibels:

$$N_T = N_P \cdot 10^{\left(\frac{0,1 \cdot L_{WT} - 0,1 \cdot L_{WP}}{E}\right)} \quad (2)$$

Here E is the scaling exponent (described below). Once N_T is known, the flow and pressure are scaled to this fan speed:

$$Q_T = Q_P \left(\frac{N_T}{N_P}\right) \quad (3a)$$

$$P_T = P_P \left(\frac{N_T}{N_P}\right)^2 \quad (3b)$$

For example, again using the indicated data point in Figure 2 and the results of 5.4, N_P is 6 304 RPM, P_P is 78,6 Pa, Q_P is 3,54 m³/h, and L_{WP} is 49,7 dBA. Applying (2) and (3) with an L_{WT} of 50 dBA and E of 6,0 results in N_T of 6 377 RPM, Q_T of 3,58 m³/h, and P_T of 80,5 Pa.

The set of all points (Q_T , P_T) then represents an estimate of the iso-acoustic fan curve for a given L_{WT} . A fitting function, typically a low-order polynomial, is then used to describe the final iso-acoustic curve, as shown in Figure 9 for a sound power level of 50 dBA and scaling exponent of 6,0. The scaling exponent is chosen to minimize the spread in the (Q_T , P_T) scaled data, and this is why acoustic plenum data must be collected at a minimum of two different voltages. The scaling exponent is normally in the range of 5,0 to 7,0 depending on the fan design. A value between 5,0 to 6,5 is common for blowers used in cooling of notebook computers.

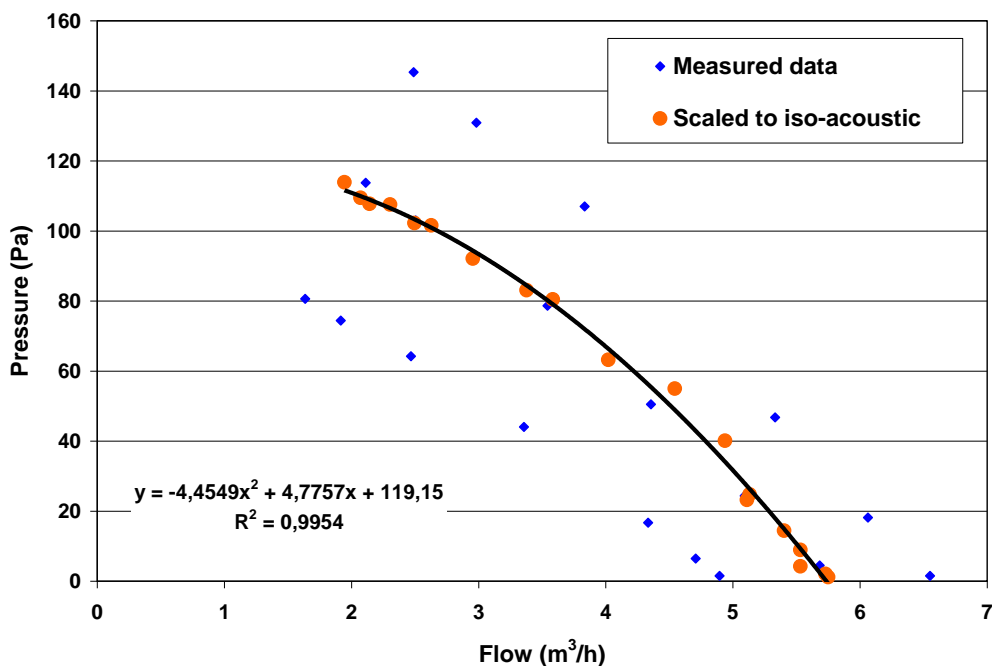

Figure 9 — Scaled 50 dBA iso-acoustic fan curve ($E = 6,0$)

In order to demonstrate the effect of the scaling exponent and various sound power targets, consider the following figures. Figure 10 shows a scaling exponent of 5,0, while Figure 11 shows a scaling exponent of 7,0, both at a sound power level target of 50 dBA. It can be seen that the scaling exponent exerts some influence on the iso-acoustic curve, but the final result is not dramatically different due to the averaging effect of the fitting function. Figure 12 shows a sound power level target of 45 dBA, while Figure 13 shows a sound power level target of 55 dBA, both with a scaling exponent of 6,0. At 45 dBA, the resulting iso-acoustic curve is on the lower edge of the measured data, while at 55 dBA the curve is beyond the measured data. Since acoustic plenum data was taken at 100% of the rated voltage, this fan would not be expected to reach the 55 dBA iso-acoustic fan curve under normal circumstances. Caution should also be used when estimating iso-acoustic curves below the measured data as the fan may not operate in a stable fashion at low speeds.

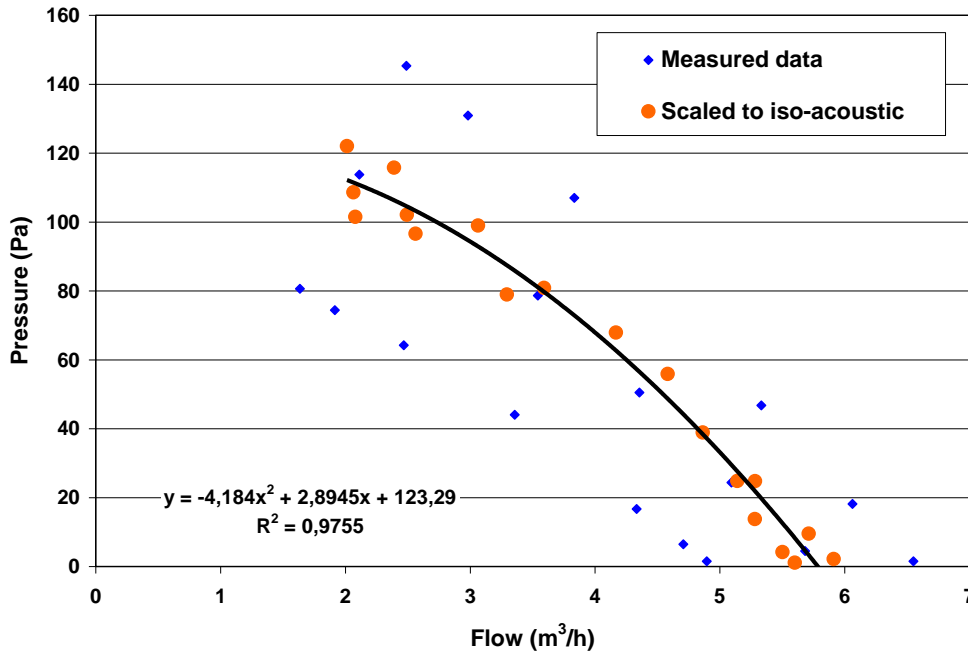

Figure 10 — Scaled 50 dBA iso-acoustic fan curve ($E = 5,0$)

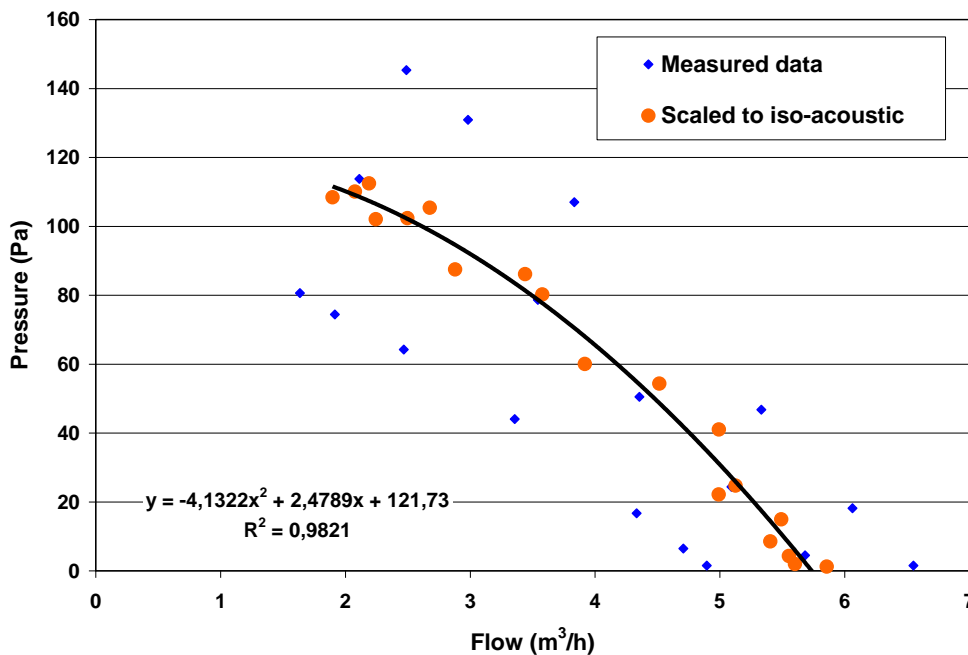

Figure 11 — Scaled 50 dBA iso-acoustic fan curve ($E = 7,0$)

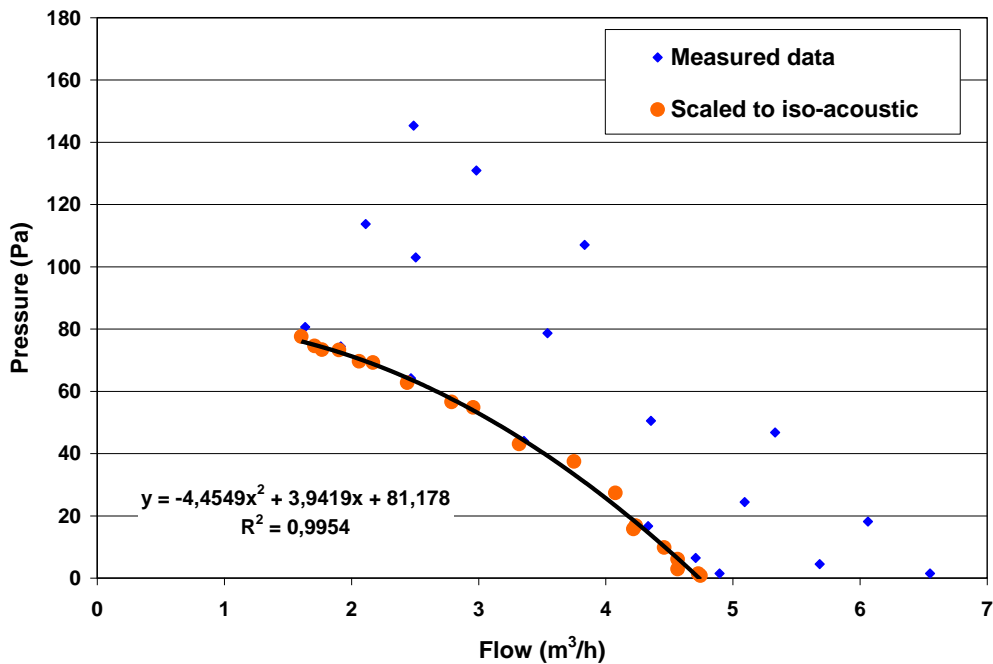

Figure 12 — Scaled 45 dBA iso-acoustic fan curve ($E = 6,0$)

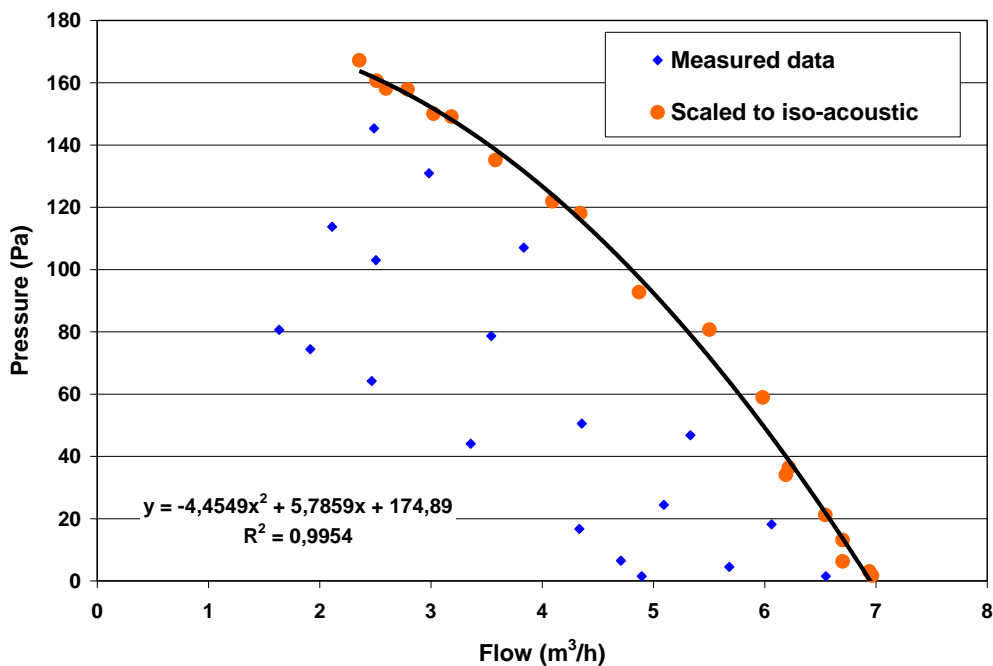

Figure 13 — Scaled 55 dBA iso-acoustic fan curve ($E = 6,0$)

5.6 Comparison to manual iso-acoustic data

Figure 14 is a comparison between data points that are manually adjusted on the acoustic plenum to a sound power level of 48 dBA and an iso-acoustic fan curve derived using the above procedure. The manual data points were not used in determining the iso-acoustic fan curve. As can be seen from the figure, the agreement is good.

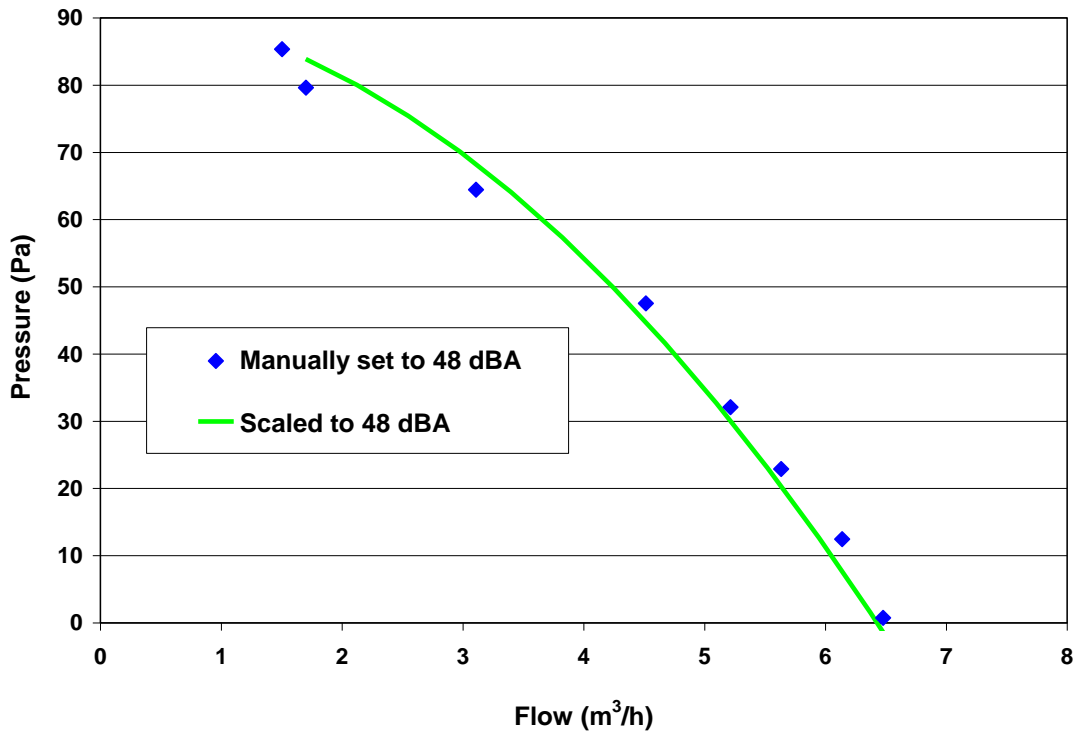

Figure 14 — Comparison to manual iso-acoustic data

5.7 Iso-acoustic fan curve test report

The test report for the iso-acoustic fan curve shall include the sound power level target and scaling exponent, in addition to the scaled iso-acoustic data points and the fitting curve. The equation describing the fitting curve is optional. The preferred sound power level targets are intervals of 5 dB, and a level should be chosen so that the resulting iso-acoustic curve is within the measured performance envelope. For blowers used in cooling of notebook computers, a sound power level target of 40 dBA, 45 dBA, or 50 dBA is suggested. A sample report is shown in Figure 15. If the plenum performance data is provided, so that other iso-acoustic fan curves may be calculated, a range of suitable sound power level targets within the performance capabilities of the fan shall also be specified. Unless otherwise stated in the test report, it is assumed that no inlet restriction fixture is used.

NOTE Additional detail is required if an inlet restriction fixture is used. See 6.4.

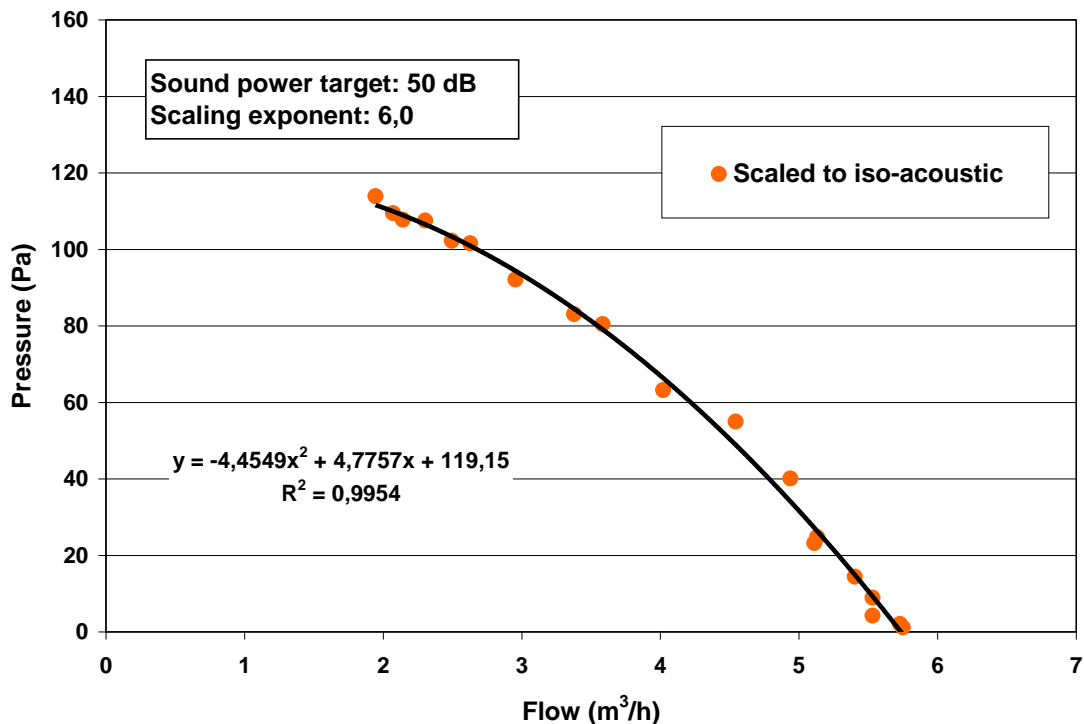

Figure 15 — Sample iso-acoustic fan curve test report

6 Inlet restriction fixture

6.1 Overview

An inlet restriction fixture can provide fan data that is more predictive of real world performance in specific applications. Because the inlet conditions are unique to each application, system designers are encouraged to develop relevant test fixtures in conjunction with their fan suppliers. Performance in the fixture can be used to compare one fan design with another, and, if correlation work has been done, to predict absolute noise emission from the actual system. Such a correlation has been done for the fixture described in the next section.

6.2 Notebook inlet restriction fixture

The most salient feature about centrifugal blowers as used in cooling of notebook computers is that they are installed in a very restricted space, with typically a few millimeters of free space at each inlet. The following test fixture can be used to emulate this condition for single-outlet blowers. The basic design has been successfully used with blowers up to 70 mm in width and 20 mm in height.

The test fixture has two components, the adapter and the inlet restriction plates. The adapter is shown in Figure 16 with a blower installed, and is custom made for each type of blower to be tested. The adapter is made from polycarbonate using the FDM (Fused Deposition Modeling) process, and has mounting holes to match the AFC and acoustic plenum as well as fixed mounts for the inlet restriction plates. Using the FDM process, it is easier to make a new adapter for each desired plate spacing rather than using an adjustable fixture, although that is also a possibility. Care should be taken that any adjustment mechanism shall not interfere with the propagation of airborne sound from the blower or generate any additional sound radiation itself.

Unlike an axial fan, which can be screwed to a frame, a blower must be held by its outlet. As shown in Figure 16, the blower is inserted a few millimeters into the fixture. Since blowers in this size class are typically quite

light, a friction fit with the adapter is usually sufficient to hold the blower. Putty can be used for additional sealing, especially if the blower outlet is irregular in shape.

Figure 17 shows the complete test fixture with inlet restriction plates. The plates are inserted into a groove running the entire width of the adapter, and held in position by brackets on either end of the adapter. The preferred plate to plate spacing is a multiple of 2 mm. The plates are made of acrylic, so that an optical tachometer can be used during testing. Plate dimensions of 120 mm by 75 mm by 1,5 mm may be used for fans up to 70 mm in width or depth. For a dual-inlet blower, the inlets are normally centered within the plate gap; the outlet might not be centered due to expansion of the fan case at the outlet. A single-inlet blower is normally biased against one of the restriction plates.

Figure 18 shows a dimensional sketch of a typical adapter, while Figure 19 shows a cross-section of the adapter.

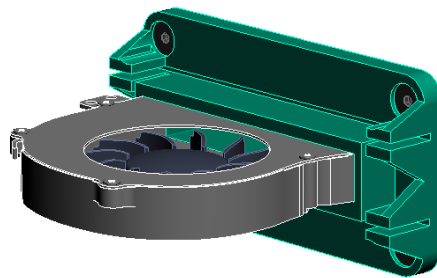

Figure 16 — Blower and adapter

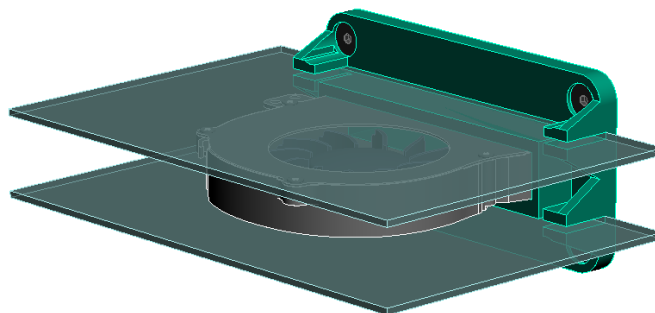

Figure 17 — Complete test fixture with inlet restriction plates

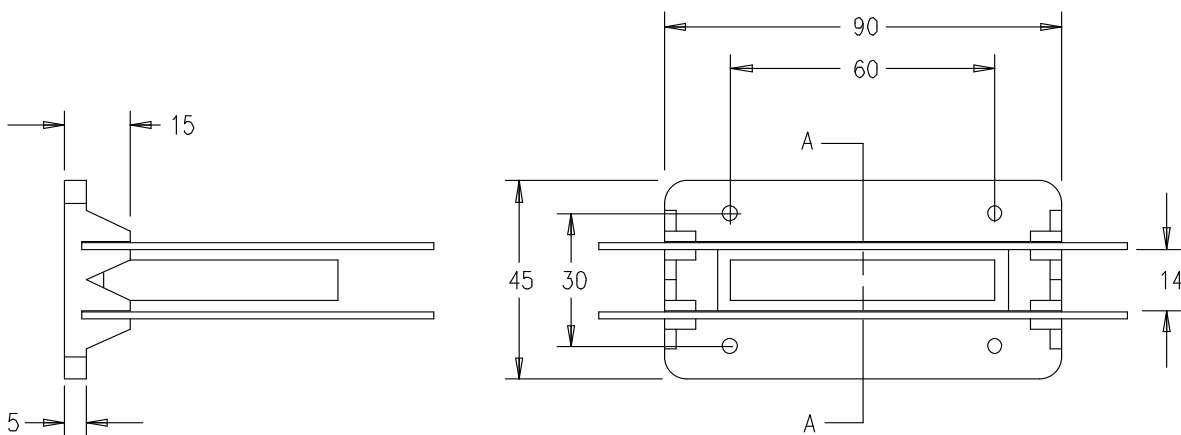

Figure 18 — Dimensional sketch of inlet restriction fixture. Units of mm.

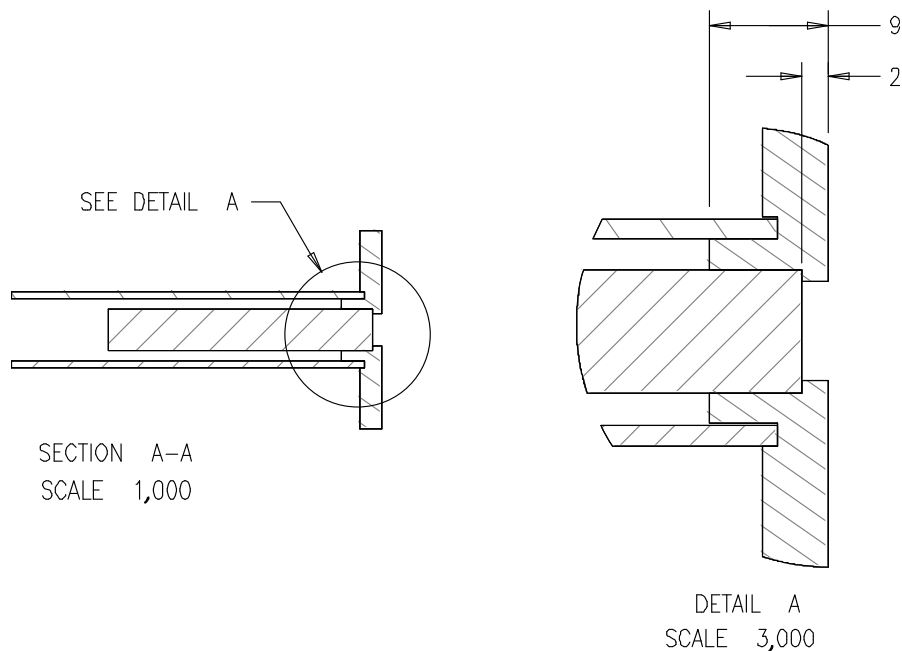

Figure 19 — Cross-section of blower adapter. Units of mm.

6.3 Comparison to in-system noise

Figure 20 shows a comparison between the sound power levels of four actual notebook computers and the sound power levels of their fans in fixtures like that described in the previous section when mounted on an acoustic plenum. For each system, the plate to plate spacing of the fixture matches the internal height of the system, and the fan is centered between the plates regardless of its positioning in the system. For all data points, the flow rate and fan speed are matched between the actual system and the acoustic plenum. As can be seen from the figure, the agreement is good.

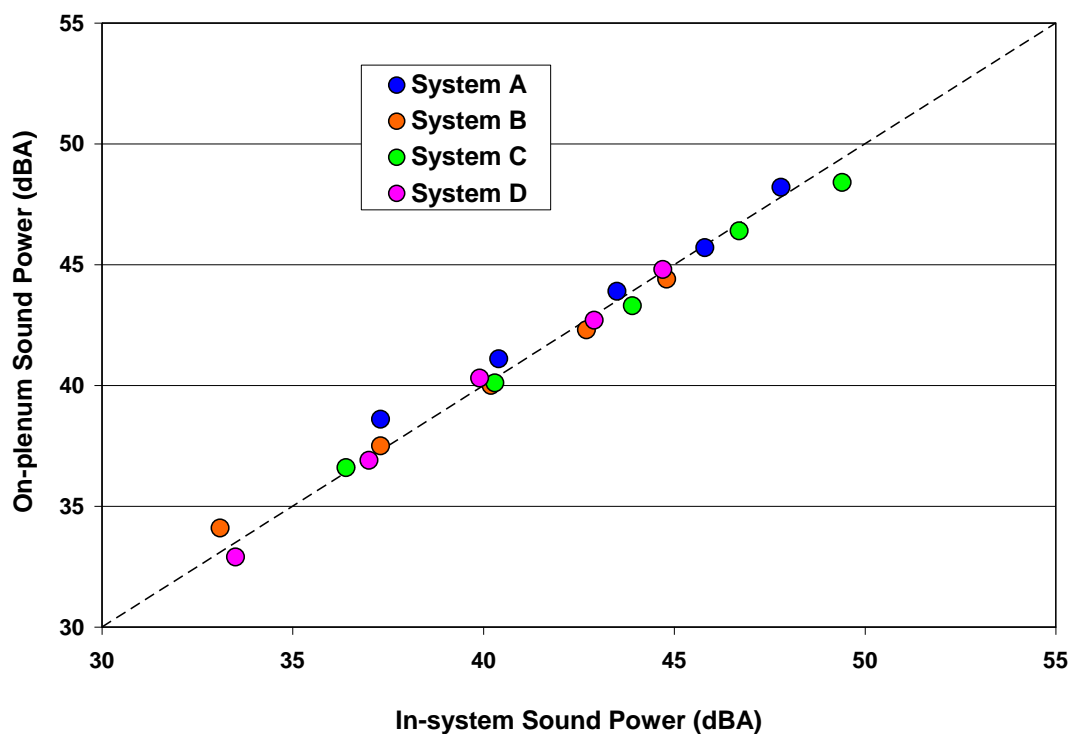

Figure 20 — Comparison of plate fixture on acoustic plenum to in-system noise

6.4 Iso-acoustic fan curve test report with inlet restriction fixture

An iso-acoustic fan curve test report with an inlet restriction fixture shall include the pertinent details of the inlet fixture in addition to the requirements of 5.7. If a fixture similar to that in 6.2 is used, the plate to plate spacing, restriction plate size, and blower location within the plates shall be specified. A sample test report is shown in Figure 21.

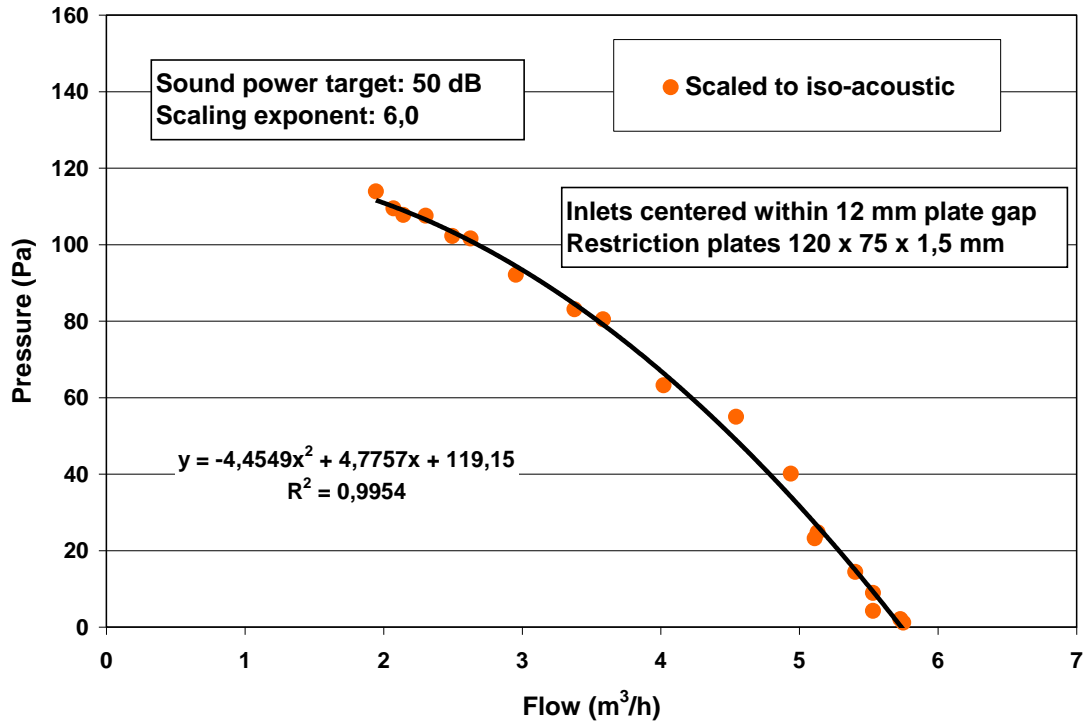

Figure 21 — Sample test report with inlet restriction

Annex A (informative)

Sample Data

Table A.1 — Airflow chamber data

Voltage	Speed	Flow	Pressure
V	RPM	m³/h	Pa
5	8 270	1,30	186,14
5	8 050	1,72	170,21
5	7 780	2,36	148,31
5	7 515	3,16	133,88
5	7 061	4,28	94,06
5	6 575	5,47	46,29
5	6 345	6,29	16,92
5	6 250	6,69	1,99
3	5 780	0,65	91,08
3	5 597	1,12	82,12
3	5 538	1,28	78,88
3	5 365	1,81	69,68
3	5 133	2,51	56,74
3	4 905	3,17	41,56
3	4 673	3,88	20,16
3	4 481	4,62	1,99

Table A.2 — Acoustic plenum data

Voltage	Speed	Pressure	Sound Power
V	RPM	Pa	dBA
3	5 680	80,63	45,5
3	5 565	74,40	45,2
3	5 414	64,20	45,3
3	5 108	44,05	45,3
3	4 764	16,67	45,7
3	4 665	6,47	45,8
3	4 620	1,49	45,9
4	6 790	113,72	50,5
4	6 614	103,02	50,1
4	6 304	78,64	49,7
4	5 920	50,52	48,9
4	5 669	24,39	49,8
4	5 473	4,48	50,7
5	7 700	145,33	53,9
5	7 495	130,89	53,3
5	7 205	107,00	53,3
5	6 530	46,78	52,0
5	6 272	18,17	53,0
5	6 164	1,49	53,4

Table A.3 — Constant fan speed data (6 304 RPM)

Flow m ³ /h	Pressure Pa
0,99	108,16
1,35	104,38
1,91	97,38
2,65	94,21
3,83	74,98
5,25	42,55
6,25	16,70
6,75	2,03
0,70	108,34
1,27	104,18
1,46	102,22
2,13	96,20
3,08	85,58
4,07	68,64
5,24	36,68
6,50	3,94

Table A.4 — Estimated flow rate data

Voltage V	Speed RPM	Pressure Pa	Sound Power dBA	Estimated Flow m ³ /h
3	5 680	80,63	45,5	1,64
3	5 565	74,40	45,2	1,92
3	5 414	64,20	45,3	2,47
3	5 108	44,05	45,3	3,36
3	4 764	16,67	45,7	4,33
3	4 665	6,47	45,8	4,71
3	4 620	1,49	45,9	4,89
4	6 790	113,72	50,5	2,11
4	6 614	103,02	50,1	2,51
4	6 304	78,64	49,7	3,54
4	5 920	50,52	48,9	4,36
4	5 669	24,39	49,8	5,09
4	5 473	4,48	50,7	5,68
5	7 700	145,33	53,9	2,49
5	7 495	130,89	53,3	2,98
5	7 205	107,00	53,3	3,83
5	6 530	46,78	52,0	5,33
5	6 272	18,17	53,0	6,06
5	6 164	1,49	53,4	6,55

Table A.5 — Iso-acoustic data (50 dBA, $E = 6,0$)

Speed RPM	Flow m³/h	Pressure Pa
6 751	1,94	113,89
6 691	2,30	107,55
6 484	2,96	92,09
6 118	4,02	63,18
5 619	5,11	23,19
5 481	5,53	8,93
5 407	5,73	2,05
6 661	2,07	109,44
6 589	2,50	102,23
6 377	3,58	80,47
6 175	4,54	54,97
5 713	5,13	24,76
5 328	5,53	4,24
6 630	2,14	107,73
6 603	2,63	101,60
6 348	3,38	83,06
6 048	4,94	40,13
5 590	5,40	14,43
5 410	5,75	1,15



Bibliography

- [1] Wolfgang Neise, "Application of Similarity Laws to the Blade Passage Sound of Centrifugal Fans" *Journal of Sound and Vibration* **43**(1): 61-75, 1975.
- [2] Willem M. Beltman, "Quantification and modeling of fan installation effects", *Noise-Con Proc.* **115**, 269, 2006.
- [3] Eric Baugh, "Impact of inlet restriction on acoustics for blowers in notebook PCs", *Noise-Con Proc.* **115**, 196, 2006.
- [4] David A. Nelson, "Axial fan installation effects due to inlet flow distortions", *Noise-Con Proc.* **115**, 3330, 2006.
- [5] Eric Baugh and Mark MacDonald, "Constant sound power fan curves for small blowers", *Noise-Con Proc.* **116**, 241, 2007.
- [6] Eric Baugh, "Comparison of on-plenum to in-system blower noise", *Noise-Con Proc.* **116**, 230, 2007.
- [7] Eric Baugh, "Fan optimization for mobile system installed conditions", *Noise-Con Proc.* **116**, 250, 2007.
- [8] Mark MacDonald and Eric Baugh, "Outlet interaction effects in small, dual outlet blowers", *Noise-Con Proc.* **117**, 165, 2008.
- [9] Mark A. MacDonald, Jessica Gullbrand, Yoshifumi Nishi, and Eric Baugh, "Notebook blower inlet flow and acoustics: Experiments and simulations", *Noise Control Eng. J.* **57**, 348, 2009.
- [10] David Nelson, "Estimating noise emission from fan-cooled packages", *Noise-Con Proc.* **218**, 549, 2009.
- [11] Willem M. Beltman, "Constant-acoustic fan curves for 92 millimeter axial fans", *Noise-Con Proc.* **220**, 1059, 2010.
- [12] Charles Oppenheimer, "Fan noise prediction for design", *Noise-Con Proc.* **220**, 138, 2010.

