

ECMA

Standardizing Information and Communication Systems

**Private Integrated Services Network
(PISN) -
Cordless Terminal Mobility (CTM) -
Inter-Exchange Signalling Protocol -
Cordless Terminal Incoming Call
Additional Network Feature**

ECMA

Standardizing Information and Communication Systems

**Private Integrated Services Network
(PISN) -
Cordless Terminal Mobility (CTM) -
Inter-Exchange Signalling Protocol -
Cordless Terminal Incoming Call
Additional Network Feature**

(QSIG-CTMI)

Brief History

This Standard is one of a series of ECMA Standards defining services and signalling protocols applicable to Private Integrated Services Networks (PISNs). The series uses ISDN concepts as developed by ITU-T and conforms to the framework of International Standards for Open Systems Interconnection as defined by ISO/IEC. It has been produced under ETSI work item DE/ECMA-00113.

This particular Standard specifies the signalling protocol for use at the Q reference point in support of the Cordless Terminal Incoming Call additional network feature. The protocol defined in this Standard forms part of the PSS1 protocol (informally known as QSIG).

This Standard is based upon the practical experience of ECMA member companies and the results of their active and continuous participation in the work of ISO/IEC JTC1, ITU-T, ETSI and other international and national standardization bodies. It represents a pragmatic and widely based consensus.

Compared to the 1st Edition of Standard ECMA-215 (published by ECMA in December 1994), various changes have been made in order to achieve alignment with ETS 300 696 (which is based on the 1st Edition of ECMA-215 but modified during Public Enquiry).

List of corrected errata for ECMA-215

21 August 1998

Summary

Following is a summary of the errors detected and corrected in Standard ECMA-215, Private Integrated Services Network - Inter-Exchange Signalling Protocol - Cordless Terminal Incoming Call Additional Network Feature.

General

- The spelling of `invalidServedUserNumber` is not correct, make a global replace of “`invalidServedUserNr`” by “`invalidServedUserNumber`”.

Clause 6.3.1, beginning of table 1

- `invalidServedUserNumber` missing in the IMPORT statement.

Corrected:

```
Name FROM Name-Operations
    { iso (1) standard (0)
      pss1-name (13868) name-operations (0) }

basicServiceNotProvided, invalidServedUserNumber, notAvailable FROM General-Error-List
ccitt (0) recommendation (0) q (17) 950 general-error-list (1) }
```

Original:

```
Name FROM Name-Operations
    { iso (1) standard (0)
      pss1-name (13868) name-operations (0) }

basicServiceNotProvided, notAvailable FROM General-Error-List
    { ccitt (0) recommendation (0) q (17) 950 general-error-list (1) }
```

Clause 6.3.1, end of table 1

- value assignments for operations and errors are not in line with recommendation ITU-T X.208, insert “`localValue`” before the value.
- error `notAuthorized` is not used, remove the definition.

Corrected:

<code>ctmiEnquiry</code>	<code>CtmiEnquiry</code>	::= <code>localValue 54</code>
<code>ctmiDivert</code>	<code>CtmiDivert</code>	::= <code>localValue 55</code>
<code>ctmiInform</code>	<code>CtmiInform</code>	::= <code>localValue 56</code>
<code>locationNotKnown</code>	<code>ERROR</code>	::= <code>localValue 1015</code>
<code>unspecified</code>	<code>Unspecified</code>	::= <code>localValue 1008</code>
<code>Unspecified</code>	::= <code>ERROR PARAMETER Extension</code>	
END -- of CTM-Incoming-call-Operations		

Original:

ctmiEnquiry	CtmiEnquiry	::= 54
ctmiDivert	CtmiDivert	::= 55
ctmiInform	CtmiInform	::= 56
notAuthorized	ERROR	::= 1007
locationNotKnown	ERROR	::= 1015
unspecified	Unspecified	::= 1008
Unspecified	::= ERROR PARAMETER Extension	

END -- of CTM-Incoming-call-Operations

Table of contents

1 Scope	1
2 Conformance	1
3 References (normative)	1
4 Definitions	2
4.1 External definitions	2
4.2 Call, Basic call	3
4.3 CTMI-detect PINX	3
4.4 Rerouteing PINX	3
5 List of acronyms	3
6 Signalling protocol for the support of ANF-CTMI	4
6.1 ANF-CTMI description	4
6.2 ANF-CTMI operational requirements	4
6.2.1 Requirements on the Rerouteing PINX	4
6.2.2 Requirements on the CTMI-detect PINX	4
6.2.3 Requirements on the Home PINX	4
6.2.4 Requirements on the Visitor PINX	4
6.2.5 Requirements on a Transit PINX	4
6.3 ANF-CTMI coding requirements	5
6.3.1 Operations	5
6.3.2 Information elements	7
6.3.3 Messages	7
6.4 ANF-CTMI state definitions	7
6.4.1 States at the Rerouteing PINX	7
6.4.2 States at the CTMI-detect PINX	7
6.4.3 States at the Home PINX	7
6.4.4 States at the Visitor PINX	8
6.5 ANF-CTMI signalling procedures for invocation and operation	8
6.5.1 Actions at the Rerouteing PINX	8
6.5.2 Actions at the CTMI-detect PINX	8
6.5.3 Actions at the Home PINX	10
6.5.4 Actions at the Visitor PINX	11
6.5.5 Actions at a Transit PINX	11
6.5.6 Actions at an Originating PINX	11
6.6 ANF-CTMI impact of interworking with public ISDNs	11
6.7 ANF-CTMI impact of interworking with non-ISDNs	11
6.8 Protocol interactions between ANF-CTMI and other supplementary services and ANFs	11
6.8.1 Interaction with Calling Name Identification Presentation (SS-CNIP)	12
6.8.2 Interaction with Connected Name Identification Presentation (SS-CONP)	12

6.8.3 Interaction with Call Forwarding Unconditional (SS-CFU)	12
6.8.4 Interaction with Call Forwarding Busy (SS-CFB)	12
6.8.5 Interaction with Call Forwarding No Reply (SS-CFNR)	12
6.8.6 Interaction with Path Replacement (ANF-PR)	12
6.8.7 Interaction with Call Transfer (SS-CT)	12
6.8.8 Interaction with Call Completion to Busy Subscriber (SS-CCBS)	12
6.8.9 Interaction with Call Completion on No Reply (SS-CCNR)	12
6.8.10 Interaction with Call Offer (SS-CO)	12
6.8.11 Interaction with Do Not Disturb (SS-DND)	12
6.8.12 Interaction with Do Not Disturb Override (SS-DNDO)	12
6.8.13 Interaction with Call Intrusion (SS-CI)	13
6.8.14 Interaction with Cordless Terminal Location Registration (SS-CTLR)	13
6.8.15 Interaction with Recall (SS-RE)	13
6.8.16 Interaction with Advice Of Charge (SS-AOC)	13
6.8.17 Interaction with Call Interception (ANF-CINT)	13
6.9 ANF-CTMI parameter values (timers)	13
6.9.1 Timer T1	13
6.9.2 Timer T2	13
Annex A -Protocol Implementation Conformance Statement (PICS) proforma	15
Annex B - Examples of Message Sequences	21
Annex C - Specification and Description Language (SDL) Representation of Procedures	27
Annex D - Bibliography	33
Annex E - Imported ASN.1 definitions	35

1 Scope

This Standard specifies the signalling protocol for the support of the Cordless Terminal Incoming Call additional network feature (ANF-CTMI) at the Q reference point between Private Integrated Services Network Exchanges (PINXs) connected together within a Private Integrated Services Network (PISN).

ANF-CTMI is a feature that directs incoming calls to a CTM user within the PISN regardless of the CTM user's geographical location within the PISN, provided that the CTM user's location is known. Roaming outside the PISN is outside the scope of this edition of this Standard.

The Q reference point is defined in ISO/IEC 11579-1.

Service specifications are produced in three stages and according to the method specified in ETS 300 387. This Standard contains the stage 3 specification for the Q reference point and satisfies the requirements (concerning ANF-CTMI) identified by the stage 1 and stage 2 specifications in ETS 300 694 and ETS 300 695.

The signalling protocol for ANF-CTMI operates on top of the signalling protocol for basic circuit switched call control, as specified in ECMA-143, and uses certain aspects of the generic procedures for the control of supplementary services specified in ECMA-165.

This Standard also specifies additional signalling protocol requirements for the support of interactions at the Q reference point between ANF-CTMI and other supplementary services and ANFs.

NOTE 1

Additional interactions that have no impact on the signalling protocol at the Q reference point can be found in the relevant stage 1 specifications.

This Standard is applicable to PINXs which can interconnect to form a PISN.

2 Conformance

In order to conform to this Standard, a PINX shall satisfy the requirements identified in the Protocol Implementation Conformance Statement (PICS) proforma in annex A.

Conformance to this Standard includes conforming to those clauses that specify protocol interactions between ANF-CTMI and other supplementary services and ANFs for which signalling protocols at the Q reference point are supported in accordance with the stage 3 standards concerned.

3 References (normative)

The following standards contain provisions which, through reference in this text, constitute provisions of this Standard. All standards are subject to revision, and parties to agreements based on this Standard are encouraged to investigate the possibility of applying the most recent editions of the standards indicated below.

In the case of references to ECMA Standards that are aligned with ISO/IEC International Standards, the number of the appropriate ISO/IEC International Standard is given in brackets after the ECMA reference.

ECMA-142	Private Integrated Services Network - Circuit-mode 64 kbit/s Bearer Services - Service Description, Functional Capabilities and Information Flows (International Standard ISO/IEC 11574)
ECMA-143	Private Integrated Services Network - Circuit-mode Bearer Services - Inter-Exchange Signalling Procedures and Protocol (International Standard ISO/IEC 11572)
ECMA-164	Private Integrated Services Network - Inter-Exchange Signalling Protocol - Name Identification Supplementary Services (International Standard ISO/IEC 13868)
ECMA-165	Private Integrated Services Network - Generic Functional Protocol for the Support of Supplementary Services - Inter-Exchange Signalling Procedures and Protocol (International Standard ISO/IEC 11582)
ECMA-174	Private Integrated Services Network - Inter-Exchange Signalling Protocol - Call Diversion Supplementary Services (International Standard ISO/IEC 13873)

ECMA-192	Private Integrated Services Network - Inter-Exchange Signalling Protocol - Call Offer Supplementary Service (International Standard ISO/IEC 14843)
ECMA-194	Private Integrated Services Network - Inter-Exchange signalling protocol - Do Not Disturb and Do Not Disturb Override Supplementary Services (International Standard ISO/IEC 14844)
ECMA-203	Private Integrated Services Network - Inter-Exchange Signalling Protocol - Call Intrusion Supplementary Service (International Standard ISO/IEC 14846)
ECMA-212	Private Integrated Services Network - Inter-Exchange Signalling Protocol - Advice of Charge Supplementary Services (International Standard ISO/IEC 15050)
ISO/IEC 11571	Information technology - Telecommunications and information exchange between systems - Numbering and sub-addressing in private integrated services networks
ISO/IEC 11579-1	Information technology - Telecommunications and information exchange between systems - Private Integrated Services Network - Part 1: Reference configuration for PISN Exchanges (PINX)
ETS 300 387	Private Telecommunication Network (PTN); Method for the specification of basic and supplementary services (1994)
ETS 300 415	Private Telecommunication Network (PTN); Terms and definitions (1995)
ETS 300 695	Private Integrated Services Network (PISN); Cordless Terminal Mobility (CTM); Call handling additional network features; Functional capabilities and information flows (1996)
ITU-T Rec. I.112	Vocabulary of terms for ISDNs (1993)
ITU-T Rec. I.210	Principles of telecommunication services supported by an ISDN and the means to describe them (1993)
ITU-T Rec. Q.850	Usage of cause and location in the digital subscriber signalling system No. 1 and the signalling system No. 7 ISDN user part (1993)
ITU-T Rec. Q.950	Digital Subscriber Signalling System No. 1 (DSS 1) - Supplementary services protocols, structure and general principles (1993)
ITU-T Rec. Z.100	Specification and description language (1993)

4 Definitions

For the purposes of this Standard, the following definitions apply.

4.1 External definitions

This Standard uses the following terms defined in other documents:

- Application Protocol Data Unit (APDU) (ECMA-165)
- Basic Service (ITU-T Rec. I.210)
- Complete Number (ISO/IEC 11571)
- Co-ordination Function (ECMA-165)
- CTM user (ETS 300 695)
- End PINX (ECMA-165)
- Gateway PINX (ECMA-143)
- Home data base (HDB) (ETS 300 415)
- Home PINX (ETS 300 695)
- Originating PINX (ECMA-165)
- Private Integrated Services Network (PISN) (ISO/IEC 11579-1)

- Private Integrated Services Network Exchange (PINX) (ISO/IEC 11579-1)
- PISN Number (ISO/IEC 11571)
- Signalling (ITU-T Rec. I.112)
- Supplementary Service (ITU-T Rec. I.210)
- Supplementary Services Control Entity (ECMA-165)
- Terminating PINX (ECMA-165)
- Transit PINX (ECMA-165)
- User (ECMA-142)
- Visitor area (ETS 300 415)
- Visitor data base (VDB) (ETS 300 415)
- Visitor PINX (ETS 300 695)

4.2 Call, Basic call

An instance of the use of a basic service.

4.3 CTMI-detect PINX

The PINX which detects that an incoming call is to a CTM user.

NOTE 2

The CTMI-detect PINX is either the Home PINX, a Transit PINX, the Incoming Gateway PINX or the Originating PINX.

4.4 Rerouteing PINX

The PINX which executes the rerouteing of the CTMI call to the current Visitor PINX.

NOTE 3

In case of rerouteing, the Rerouteing PINX is either the Originating PINX or the Incoming Gateway PINX. In case of forward switching, the Rerouteing PINX is the CTMI-detect PINX.

5 List of acronyms

ANF	Additional Network Feature
ANF-CTMI	Cordless Terminal Incoming Call additional network feature
APDU	Application Protocol Data Unit
ASN.1	Abstract Syntax Notation no. 1
CTM	Cordless Terminal Mobility
HDB	Home Data Base
ISDN	Integrated Services Digital Network
NFE	Network Facility Extension
PICS	Protocol Implementation Conformance Statement
PISN	Private Integrated Services Network
PINX	Private Integrated Services Network Exchange
SDL	Specification and Description Language
SS-AOC	Advice Of Charge supplementary service
SS-CFU	Call Forwarding Unconditional supplementary service

SS-CI	Call Intrusion supplementary service
SS-CO	Call Offer supplementary service
SS-DNDO	Do Not Disturb Override supplementary service
VDB	Visitor Data Base

6 Signalling protocol for the support of ANF-CTMI

6.1 ANF-CTMI description

ANF-CTMI enables calls to be directed to a CTM user within the PISN. As there is no predetermined PINX for the connection of a CTM user to the PISN, the directing of such calls requires that information regarding the location of the user is available.

6.2 ANF-CTMI operational requirements

6.2.1 Requirements on the Rerouteing PINX

ECMA-143 protocol control procedures for call establishment at the outgoing side of an inter-PINX link shall apply to the establishment of the connection to the Visitor PINX. ECMA-143 protocol control procedures for call clearing shall apply to the release of the connection to the CTMI-detect PINX.

Generic procedures for the call-related control of supplementary services, as specified in ECMA-165 for an End PINX, shall apply.

6.2.2 Requirements on the CTMI-detect PINX

ECMA-143 protocol control procedures for call establishment at the incoming side of an inter-PINX link shall apply to the establishment of the connection from the Originating or Incoming Gateway PINX. ECMA-143 protocol control procedures for call clearing shall apply to the release of the connection to the Rerouteing PINX.

Generic procedures for the call-related control of supplementary services, as specified in ECMA-165 for an End PINX, shall apply.

Generic procedures for the call independent control (connection oriented) of supplementary services, as specified in ECMA-165 for an Originating PINX, shall apply.

6.2.3 Requirements on the Home PINX

Generic procedures for the call independent control (connection oriented) of supplementary services, as specified in ECMA-165 for a Terminating PINX, shall apply.

6.2.4 Requirements on the Visitor PINX

ECMA-143 protocol control procedures for call establishment at the incoming side of an inter-PINX link shall apply to the establishment of the connection from the Rerouteing PINX.

Generic procedures for the call-related control of supplementary services, as specified in ECMA-165 for an End PINX, shall apply.

6.2.5 Requirements on a Transit PINX

Basic call procedures for call establishment and call clearing at a Transit PINX, as specified in ECMA-143, shall apply.

Generic procedures for the call-related control and call independent control (connection oriented) of supplementary services, as specified in ECMA-165 for a Transit PINX, shall apply.

6.3 ANF-CTMI coding requirements

6.3.1 Operations

The operations defined in Abstract Syntax Notation number 1 (ASN.1) in table 1 shall apply.

Table 1 - Operations in Support of ANF-CTMI

CTM-Incoming-call-Operations { iso identified-organization icd-ecma (0012) standard (0) qsig-ctm-incoming-call (215) ctmi-operations (0) }
DEFINITIONS EXPLICIT TAGS ::=
BEGIN
IMPORTS OPERATION, ERROR FROM Remote-Operation-Notation { joint-iso-ccitt (2) remote-operations (4) notation (0) } Extension FROM Manufacturer-specific-service-extension-definition { iso (1) standard (0) pss1-generic-procedures (11582) msi-definition (0) } PSS1InformationElement FROM Generic-parameters-definition { iso (1) standard (0) pss1-generic-procedures (11582) pss1-generic-parameters (6) } Name FROM Name-Operations { iso (1) standard (0) pss1-name (13868) name-operations (0) } basicServiceNotProvided, invalidServedUserNumber, notAvailable FROM General-Error-List { ccitt (0) recommendation (0) q (17) 950 general-error-list (1) } Address, PartyNumber, PartySubaddress, PresentedNumberScreened FROM Addressing-Data-Elements { iso (1) standard (0) pss1-generic-procedures (11582) addressing-data-elements (9) };
CtmiEnquiry ::= OPERATION -- Sent from the CTMI-detect PINX to the Home PINX. ARGUMENT EnquiryArg RESULT EnquiryRes ERRORS { invalidServedUserNumber, locationNotKnown, notAvailable, basicServiceNotProvided, unspecified }
CtmiDivert ::= OPERATION -- Sent from the CTMI-detect PINX to the Rerouteing PINX. ARGUMENT DivertArg RESULT DummyRes ERRORS { notAvailable, unspecified }
CtmiInform ::= OPERATION -- Sent from the Rerouteing PINX to the Visitor PINX. ARGUMENT InformArg

Table 1 - Operations in Support of ANF-CTMI (continued)

EnquiryArg ::= SEQUENCE	{ pisinNumber PartyNumber, -- The PISN number of the CTM user qSIGInfoElement PSS1InformationElement, -- The basic call information elements Bearer capability, High layer compatibility, -- Low layer compatibility can be embedded in the qSIGInfoElement -- in accordance with clause 6.5.2.1. argExtension CtmExtension OPTIONAL }
DivertArg ::= SEQUENCE	{ visitPINX PartyNumber, -- The PISN number of the Visitor PINX, -- always a Complete Number. callingNumber PresentedNumberScreened, pisnNumber PartyNumber, -- The PISN number of the CTM user, -- always a Complete Number. qSIGInfoElement PSS1InformationElement, -- The basic call information elements Bearer capability, High layer compatibility, -- Low layer compatibility, Progress indicator and Party category -- can be embedded in the qSIGInfoElement in accordance with clause 6.5.2.1. callingUserSub [1] PartySubaddress OPTIONAL, callingUserName [2] Name OPTIONAL, ctmUserSub [3] PartySubaddress OPTIONAL, argExtension CtmExtension OPTIONAL }
InformArg ::= SEQUENCE	{ pisinNumber PartyNumber, -- The PISN number of the CTM user, -- always a Complete Number. argExtension CtmExtension OPTIONAL }
EnquiryRes ::= CHOICE	{ currLocation [1] CurrLocation, cfuActivated [2] CfuActivated }
CurrLocation ::= SEQUENCE	{ visitPINX PartyNumber, -- The PISN number of the Visitor PINX, -- always a Complete Number. pisnNumber PartyNumber, -- The PISN number of the CTM user, -- always a complete number. argExtension CtmExtension OPTIONAL }
CfuActivated ::= SEQUENCE	{ divToAddress Address, divOptions SubscriptionOption, ctmName [1] Name OPTIONAL, argExtension CtmExtension OPTIONAL }
SubscriptionOption ::= ENUMERATED	{ noNotification (0), notificationWithoutDivertedToNr (1), notificationWithDivertedToNr (2) }
DummyRes ::= CHOICE	{ null NULL, extension [1] IMPLICIT Extension, sequOfExtn [2] IMPLICIT SEQUENCE OF Extension }
CtmExtension ::= CHOICE	{ none NULL, extension [4] IMPLICIT Extension, sequOfExtn [5] IMPLICIT SEQUENCE OF Extension }

Table 1 - Operations in Support of ANF-CTMI (concluded)

ctmiEnquiry	CtmiEnquiry	::=	localValue 54
ctmiDivert	CtmiDivert	::=	localValue 55
ctmiInform	CtmiInform	::=	localValue 56
locationNotKnown	ERROR	::=	localValue 1015
unspecified	Unspecified	::=	localValue 1008
Unspecified ::=	ERROR		PARAMETER Extension
END	-- of CTM-Incoming-call-Operations		

6.3.2 Information elements

6.3.2.1 Facility information element

The operations defined in 6.3.1 shall be coded in the Facility information element in accordance with ECMA-165.

When conveying the invoke APDU of operations defined in 6.3.1 the destinationEntity data element of the NFE shall contain value endPINX.

When conveying the invoke APDU of operations defined in 6.3.1, the Interpretation APDU shall either be omitted or be included with value rejectAnyUnrecognisedInvokePdu.

6.3.2.2 Other information elements

Any other information elements (e.g. Calling party number, Called party number) shall be coded in accordance with the rules of ECMA-143 and ECMA-165.

6.3.3 Messages

The Facility information element shall be conveyed in the messages as specified in clause 10 of ECMA-165.

Messages used for call establishment shall be as specified in ECMA-143.

6.4 ANF-CTMI state definitions

6.4.1 States at the Rerouteing PINX

The procedures for the Rerouteing PINX are written in terms of the following conceptual states existing within the ANF-CTMI Supplementary Service Control entity in that PINX in association with a particular call.

6.4.1.1 State ExecIdle

Ready for receipt of a ctmiDivert APDU.

6.4.2 States at the CTMI-detect PINX

The procedures for the CTMI-detect PINX are written in terms of the following conceptual states existing within the ANF-CTMI Supplementary Service Control entity in that PINX in association with a particular call.

6.4.2.1 State CTMI-Idle

ANF-CTMI is not operating.

6.4.2.2 State CTMI-Detected

A call to a CTM user has been detected and a ctmiEnquiry invoke APDU requesting the current location of the CTM user has been sent to the Home PINX.

6.4.2.3 State CTMI-Divert

The current location of the CTM user is known and a ctmiDivert invoke APDU has been sent to the Rerouteing PINX.

6.4.3 States at the Home PINX

The procedures for the Home PINX are written in terms of the following conceptual states existing within the ANF-CTMI Supplementary Service Control entity.

6.4.3.1 State HomeIdle

Ready for receipt of a ctmiEnquiry APDU.

6.4.4 States at the Visitor PINX

The procedures for the Visitor PINX are written in terms of the following conceptual states existing within the ANF-CTMI Supplementary Service Control entity in that PINX in association with a particular call.

6.4.4.1 State VisitIdle

Ready for receipt of a ctmiInform APDU.

6.5 ANF-CTMI signalling procedures for invocation and operation

Examples of message sequences are shown in annex B.

6.5.1 Actions at the Rerouting PINX

The SDL representation of procedures at the Rerouting PINX is shown in C.1 of annex C.

6.5.1.1 Normal procedures

On receipt of a ctmiDivert invoke APDU in a FACILITY message during basic call protocol control state Outgoing Call Proceeding, the Rerouting PINX shall determine whether it can proceed with ANF-CTMI. If so, it shall initiate a new call establishment to the Visitor PINX and release the leg towards the CTMI-detect PINX by sending a DISCONNECT message containing a ctmiDivert return result APDU.

The SETUP message for the new call establishment shall include a ctmiInform invoke APDU. A callingName invoke APDU (see ECMA-164) may be included in the SETUP message, if the element callingUserName was received in the ctmiDivert invoke APDU and if the Rerouting PINX conforms to ECMA-164.

The following specific basic call information elements shall be included in the SETUP message:

- Called party number, containing the number received in the visitPINX data element within the ctmiDivert invoke APDU;
- Called party subaddress, containing the subaddress received in the ctmiUserSub data element within the ctmiDivert invoke APDU (optional);
- Calling party number, containing the number received in the callingNumber data element within the ctmiDivert invoke APDU;
- Calling party subaddress, containing the subaddress received in the callingUserSub data element within the ctmiDivert invoke APDU (optional);
- Bearer capability information element as received in embedded form within the ctmiDivert invoke APDU, and any of the following information elements which were also received in embedded form in this APDU: High layer compatibility, Low layer compatibility, Progress indicator and Party category information elements;
- Transit counter, with value zero (optional).

The ctmiInform invoke APDU shall contain the data element pismNumber with the same contents as the corresponding data element in the argument of the received ctmiDivert invoke APDU.

6.5.1.2 Exceptional procedures

If the Rerouting PINX can not proceed with ANF-CTMI, it shall answer the ctmiDivert invoke APDU with a return error APDU containing the error notAvailable.

6.5.2 Actions at the CTMI-detect PINX

The SDL representation of procedures at the CTMI-detect PINX is shown in C.2 of annex C.

When a CTMI-detect PINX also provides Rerouting PINX functionality, in support of ANF-CTMI by forward switching, the joint requirements of 6.5.1 (for a Rerouting PINX) and 6.5.2 (for a CTMI-detect PINX) shall apply, with the exception that any communication between the CTMI-detect PINX functionality and the Rerouting PINX functionality will be an intra-PINX matter. The messages specified for sending from the CTMI-detect PINX towards the Rerouting PINX or vice versa will not appear on any inter-PINX link.

6.5.2.1 Normal procedures

On determining that ANF-CTMI is to be invoked following the arrival of an incoming call, the CTMI-detect PINX shall send a `ctmiEnquiry` invoke APDU to the Home PINX of the called CTM user, using the call reference of a call independent signalling connection. The call independent signalling connection shall be established (or used, if an appropriate connection is already available) in accordance with the procedures specified in 7.3 of ECMA-165. The CTMI-detect PINX shall enter state CTMI-Detected and start timer T1.

NOTE 4

The number to be used in the Called party number information element when establishing the call independent signalling connection to the Home PINX is outside the scope of this Standard. It can, for example, be the Called party number information element received in the incoming SETUP message.

The following data elements shall be included in the argument of the `ctmiEnquiry` invoke APDU:

- element `pisnNumber` as received in the incoming SETUP message in the Called party number information element;
- element `qSIGInfoElement` containing an embedded Bearer capability information element, as received in the incoming SETUP message, and any of the following information elements which were received in the incoming SETUP message: High layer compatibility and Low layer compatibility.

On receipt of the `ctmiEnquiry` return result APDU containing choice `currLocation`, the CTMI-detect PINX shall stop timer T1, send a `ctmiDivert` invoke APDU in a FACILITY message to the Rerouting PINX using the call reference of the incoming call, start timer T2 and enter state CTMI-Divert.

The CTMI-detect PINX is responsible for clearing the call independent signalling connection towards the Home PINX. This may occur on receipt of a return result APDU. Alternatively, the signalling connection may be retained for other applications, if appropriate.

The following data elements shall be included in the argument of the `ctmiDivert` invoke APDU:

- element `visitPINX` as received in the `ctmiEnquiry` return result APDU;
- element `callingNumber` as received in the incoming SETUP message in the Calling party number information element;
- element `pisnNumber` as received in the `ctmiEnquiry` return result APDU;
- element `qSIGInfoElement` containing an embedded Bearer capability information element, as received in the incoming SETUP message, and any of the following information elements which were received in the incoming SETUP message: High layer compatibility, Low layer compatibility, Progress indicator and Party category;
- element `callingUserSub`, if a Calling party subaddress information element was received in the incoming SETUP message;
- element `callingUserName`, if a `callingName` invoke APDU was received in the incoming SETUP message as defined in ECMA-164;
- element `ctmUserSub`, if a Called party subaddress information element was received in the incoming SETUP message.

On receipt of a `ctmiEnquiry` return result APDU containing choice `cfuActivated`, if the CTMI-detect PINX does not support the procedures of 6.8.3.1 the actions taken shall be an implementation matter, e.g. route the incoming call onwards to the Home PINX or release the incoming call.

On receipt of the `ctmiDivert` return result APDU, the CTMI-detect PINX shall stop timer T2 and enter state CTMI-Idle.

6.5.2.2 Exceptional procedures

On receipt of a `ctmiEnquiry` return error APDU from the Home PINX indicating ‘`invalidServedUserNumber`’, the CTMI-detect PINX shall stop timer T1, stimulate the sending of a DISCONNECT message with cause value #1 ‘Unallocated (unassigned) number’ for release of the basic call, and enter state CTMI-Idle.

On receipt of a ctmiEnquiry return error APDU from the Home PINX indicating 'locationNotKnown', the CTMI-detect PINX shall stop timer T1, stimulate the sending of a DISCONNECT message with cause value #3 'No route to destination' for release of the basic call, and enter state CTMI-Idle.

On receipt of a ctmiEnquiry return error APDU from the Home PINX indicating 'notAvailable', the CTMI-detect PINX shall stop timer T1, stimulate the sending of a DISCONNECT message with cause value #20 'Subscriber absent' for release of the basic call, and enter state CTMI-Idle

On receipt of a ctmiEnquiry return error APDU from the Home PINX indicating 'basicServiceNotProvided', the CTMI-detect PINX shall stop timer T1, stimulate the sending of a DISCONNECT message with cause value #88 'Incompatible destination' for release of the basic call, and enter state CTMI-Idle.

On receipt of a ctmiEnquiry reject APDU from the Home PINX, the CTMI-detect PINX shall stop timer T1, stimulate the sending of a DISCONNECT message with cause value #38 'Network out of order' for release of the basic call, and enter state CTMI-Idle.

If timer T1 expires (i.e. the ctmiEnquiry invoke APDU is not answered by the Home PINX), the CTMI-detect PINX shall stimulate the sending of a DISCONNECT message with cause value #41 'Temporary failure' for release of the basic call, and enter state CTMI-Idle.

On call clearing during state CTMI-Detected, the CTMI-detect PINX shall stop timer T1 and enter state CTMI-Idle.

On receipt of a ctmiDivert return error or reject APDU from the Rerouteing PINX, the CTMI-detect PINX shall either stop timer T2, stimulate the sending of a DISCONNECT message for release of the basic call, and enter state CTMI-Idle or provide Rerouteing PINX functionality locally by initiating a new call establishment to the Visitor PINX in accordance with 6.5.1.1.

If timer T2 expires (i.e. the ctmiDivert invoke APDU is not answered by the Rerouteing PINX), the CTMI-detect PINX shall stimulate the sending of a DISCONNECT message for release of the basic call, and enter state CTMI-Idle or provide Rerouteing PINX functionality locally by initiating a new call establishment to the Visitor PINX in accordance with 6.5.1.1.

On call clearing during state CTMI-Divert, the CTMI-detect PINX shall stop timer T2 and enter state CTMI-Idle.

The CTMI-detect PINX is responsible for clearing the call independent signalling connection towards the Home PINX. This may occur on receipt of a return error or reject APDU, on expiry of timer T1 or on call clearing during state CTMI-Detect. Alternatively, the signalling connection may be retained for other applications, if appropriate.

6.5.3 Actions at the Home PINX

The SDL representation of procedures at the Home PINX is shown in C.3 of annex C.

When a Home PINX also provides CTMI-detect PINX functionality, in support of ANF-CTMI, the joint requirements of 6.5.2 (for a CTMI-detect PINX) and 6.5.3 (for a Home PINX) shall apply, with the exception that any communication between the Home PINX functionality and the CTMI-detect PINX functionality will be an intra-PINX matter. The messages specified for sending from the Home PINX towards the CTMI-detect PINX or vice versa will not appear on any inter-PINX link.

6.5.3.1 Normal procedures

On receipt of a ctmiEnquiry invoke APDU using the call reference of a call independent signalling connection (as specified in 7.3 of ECMA-165), the Home PINX shall check that the CTM user, as identified by the PISN number in element pismNumber, is defined in the HDB and that the basic service indicated by the basic call information elements embedded in element qSIGInfoElement is provided to that user.

If the CTM user is defined in the HDB, and the current location of the CTM user is known for the basic service concerned, then the Home PINX shall answer the ctmiEnquiry invoke APDU with a return result APDU containing choice currLocation. Element visitPINX shall contain the PISN number of the Visitor PINX and element pismNumber shall contain the PISN number of the CTM user. The latter shall be in the form of a complete number even if the PISN number received in the invoke APDU was not a complete number.

6.5.3.2 Exceptional procedures

If the CTM user is not found in the HDB, the Home PINX shall answer the ctmiEnquiry invoke APDU with a return error APDU containing the error invalidServedUserNumber.

If the CTM user has deregistered, the Home PINX shall answer the ctmiEnquiry invoke APDU with a return error APDU containing the error notAvailable.

If the current location of the CTM user is unknown, the Home PINX shall answer the ctmiEnquiry invoke APDU with a return error APDU containing the error locationNotKnown.

If the requested basic service is not provided, the Home PINX shall answer the ctmiEnquiry invoke APDU with a return error APDU containing the error basicServiceNotProvided.

6.5.3.3 Additional procedures for Call Forwarding Unconditional

On receipt of a ctmiEnquiry invoke APDU, if the CTM user is defined in the HDB and SS-CFU is active, the Home PINX shall answer the ctmiEnquiry invoke APDU with a return result APDU containing choice cfuActivated.

6.5.4 Actions at the Visitor PINX

The SDL representation of procedures at the Visitor PINX is shown in C.4 of annex C.

6.5.4.1 Normal procedures

On receipt of a ctmiInform invoke APDU in a SETUP message, the Visitor PINX shall check that there is an entry in the VDB for the CTM user, as indicated by the PISN number in element pisinNumber, and the basic service indicated by basic call information elements, and that the CTM user is accessible. If so, the Visitor PINX shall attempt to establish the call to the PISN access indicated by the VDB entry.

NOTE 5

On receipt of an incoming call authentication of the CTM user can be performed.

6.5.4.2 Exceptional procedures

If the CTM user is not found in the VDB, the Visitor PINX shall initiate call clearing according to the procedures in ECMA-143 with cause value #41 'Temporary failure'.

If the CTM user is not accessible, the Visitor PINX shall initiate call clearing according to the procedures in ECMA-143 with cause value #18 'No user responding'.

6.5.5 Actions at a Transit PINX

There are no special actions required in support of ANF-CTMI.

6.5.6 Actions at an Originating PINX

An Originating PINX shall act as the Rerouteing PINX in accordance with 6.5.1, except where Rerouteing PINX functionality is provided at a separate CTMI-detect PINX.

6.6 ANF-CTMI impact of interworking with public ISDNs

When interworking with a public ISDN which does not support an equivalent feature, the Incoming Gateway PINX shall act as the Rerouteing PINX in accordance with 6.5.1 in order to perform ANF-CTMI within the PISN, except where Rerouteing PINX functionality is provided at a separate CTMI-detect PINX.

6.7 ANF-CTMI impact of interworking with non-ISDNs

When interworking with a non-ISDN which does not support an equivalent feature, the Incoming Gateway PINX shall act as the Rerouteing PINX in accordance with 6.5.1 in order to perform ANF-CTMI within the PISN, except where Rerouteing PINX functionality is provided at a separate CTMI-detect PINX.

6.8 Protocol interactions between ANF-CTMI and other supplementary services and ANFs

This clause specifies protocol interactions with other supplementary services and ANFs for which stage 3 standards had been published at the time of publication of this Standard. For interactions with supplementary services and ANFs for which stage 3 standards are published subsequent to the publication of this Standard, see those other stage 3 standards.

NOTE 6

Simultaneous conveyance of APDUs for ANF-CTMI and other supplementary services or ANFs in the same message, each in accordance with the requirements of its respective stage 3 standard, does not, on its own, constitute a protocol interaction.

6.8.1 Interaction with Calling Name Identification Presentation (SS-CNIP)

No interaction.

6.8.2 Interaction with Connected Name Identification Presentation (SS-CONP)

No interaction.

6.8.3 Interaction with Call Forwarding Unconditional (SS-CFU)

The following interaction shall apply if SS-CFU is supported in accordance with ECMA-174.

6.8.3.1 Actions at the CTMI-detect PINX

On receipt of a ctmIEnquiry return result APDU containing choice cfuActivated, the CTMI-detect PINX shall stop timer T1 and act as the Served User PINX for SS-CFU in accordance with 6.5.3 of ECMA-174.

The CTMI-detect PINX is responsible for clearing the call independent signalling connection towards the Home PINX. This may occur on receipt of a return result APDU. Alternatively, the signalling connection may be retained for other applications, if appropriate.

6.8.4 Interaction with Call Forwarding Busy (SS-CFB)

No interaction.

6.8.5 Interaction with Call Forwarding No Reply (SS-CFNR)

No interaction.

6.8.6 Interaction with Path Replacement (ANF-PR)

No interaction.

6.8.7 Interaction with Call Transfer (SS-CT)

No interaction.

6.8.8 Interaction with Call Completion to Busy Subscriber (SS-CCBS)

No interaction.

6.8.9 Interaction with Call Completion on No Reply (SS-CCNR)

No interaction.

6.8.10 Interaction with Call Offer (SS-CO)

The following interaction shall apply if SS-CO is supported in accordance with ECMA-192.

6.8.10.1 Actions at the Rerouteing PINX

When executing ANF-CTMI, the Rerouteing PINX shall act as follows:

- include a callOfferRequest invoke APDU in the SETUP message to the Visitor PINX if this was included in the original SETUP message to the CTMI-detect PINX;
- include a pathRetain invoke APDU with callOffer bit set to ONE in the SETUP message to the Visitor PINX if this was included in the original SETUP message to the CTMI-detect PINX.

6.8.11 Interaction with Do Not Disturb (SS-DND)

No interaction.

6.8.12 Interaction with Do Not Disturb Override (SS-DNDO)

The following interaction shall apply if SS-DNDO is supported in accordance with ECMA-194.

6.8.12.1 Actions at the Rerouteing PINX

When executing ANF-CTMI, the Rerouteing PINX shall act as follows:

- include a doNotDisturbOverrideQ invoke APDU in the SETUP message to the Visitor PINX if this was included in the original SETUP message to the CTMI-detect PINX;
- include a pathRetain invoke APDU with bit dndo-low, dndo-medium or dndo-high set to ONE in the SETUP message to the Visitor PINX if this was included in the original SETUP message to the CTMI-detect PINX.

6.8.13 Interaction with Call Intrusion (SS-CI)

The following interaction shall apply if SS-CI is supported in accordance with ECMA-203.

6.8.13.1 Actions at the Rerouteing PINX

When executing ANF-CTMI, the Rerouteing PINX shall act as follows:

- include a callIntrusionRequest invoke APDU in the SETUP message to the Visitor PINX if this was included in the original SETUP message to the CTMI-detect PINX;
- include a pathRetain invoke APDU with bit ci-low, ci-medium or ci-high set to ONE in the SETUP message to the Visitor PINX if this was included in the original SETUP message to the CTMI-detect PINX.

6.8.14 Interaction with Cordless Terminal Location Registration (SS-CTLR)

No interaction.

6.8.15 Interaction with Recall (SS-RE)

No interaction.

6.8.16 Interaction with Advice Of Charge (SS-AOC)

The following interaction shall apply if SS-AOC is supported in accordance with ECMA-212.

6.8.16.1 Actions at the Rerouteing PINX

When executing ANF-CTMI, the Rerouteing PINX shall include a chargeRequest invoke APDU in the SETUP message to the Visitor PINX if this was included in the original SETUP message to the CTMI-detect PINX.

6.8.17 Interaction with Call Interception (ANF-CINT)

No interaction.

6.9 ANF-CTMI parameter values (timers)

6.9.1 Timer T1

Timer T1 operates at the CTMI-detect PINX during state CTMI-Detected. Its purpose is to protect against the absence of a response to the ctmiEnquiry invoke APDU.

Timer T1 shall have a value not less than 15 s.

6.9.2 Timer T2

Timer T2 operates at the CTMI-detect PINX during state CTMI-Divert. Its purpose is to protect against the absence of a response to the ctmiDivert invoke APDU.

Timer T2 shall have a value not less than 15 s.

Annex A

(normative)

Protocol Implementation Conformance Statement (PICS) proforma

A.1 Introduction

The supplier of a protocol implementation which is claimed to conform to this Standard shall complete the following Protocol Implementation Conformance Statement (PICS) proforma.

A completed PICS proforma is the PICS for the implementation in question. The PICS is a statement of which capabilities and options of the protocol have been implemented. The PICS can have a number of uses, including use:

- by the protocol implementor, as a check list to reduce the risk of failure to conform to the Standard through oversight;
- by the supplier and acquirer, or potential acquirer, of the implementation, as a detailed indication of the capabilities of the implementation, stated relative to the common basis for understanding provided by the Standard's PICS proforma;
- by the user or potential user of the implementation, as a basis for initially checking the possibility of interworking with another implementation; while interworking can never be guaranteed, failure to interwork can often be predicted from incompatible PICSs;
- by a protocol tester, as the basis for selecting appropriate tests against which to assess the claim for conformance of the implementation.

A.2 Instructions for completing the PICS proforma

A.2.1 General structure of the PICS proforma

The PICS proforma is a fixed format questionnaire divided into sub-clauses each containing a group of individual items. Each item is identified by an item number, the name of the item (question to be answered), and the reference(s) to the clause(s) that specifies (specify) the item in the main body of this Standard.

The "Status" column indicates whether an item is applicable and if so whether support is mandatory or optional.

The following terms are used:

m	mandatory (the capability is required for conformance to the protocol);
o	optional (the capability is not required for conformance to the protocol, but if the capability is implemented it is required to conform to the protocol specifications);
o.<n>	optional, but support of at least one of the group of options labelled by the same numeral <n> is required;
x	prohibited;
c.<cond>	conditional requirement, depending on support for the item or items listed in condition <cond>;
<item>;m	simple conditional requirement, the capability being mandatory if item number <item> is supported, otherwise not applicable;
<item>;o	simple conditional requirement, the capability being optional if item number <item> is supported, otherwise not applicable.

Answers to the questionnaire items are to be provided either in the "Support" column, by simply marking an answer to indicate a restricted choice (Yes or No), or in the "Not Applicable" column (N/A).

A.2.2 Additional information

Items of Additional Information allow a supplier to provide further information intended to assist the interpretation of the PICS. It is not intended or expected that a large quantity will be supplied, and a PICS can be considered complete without any such information. Examples might be an outline of the ways in which a (single) implementation can be set up to operate in a variety of environments and configurations. References to items of Additional Information may be entered next to any answer in the questionnaire, and may be included in items of Exception information.

A.2.3 Exception information

It may occasionally happen that a supplier will wish to answer an item with mandatory or prohibited status (after any conditions have been applied) in a way that conflicts with the indicated requirement. No pre-printed answer will be found in the “Support” column for this. Instead, the supplier is required to write into the “Support” column an x.<i> reference to an item of Exception Information, and to provide the appropriate rationale in the Exception item itself.

An implementation for which an Exception item is required in this way does not conform to this Standard. A possible reason for the situation described above is that a defect in the Standard has been reported, a correction for which is expected to change the requirement not met by the implementation.

A.3 PICS proforma for ECMA-215

A.3.1 Implementation identification

Supplier	
Contact point for queries about the PICS	
Implementation Name(s) and Version(s)	
Other information necessary for full identification, e.g. Name(s) and Version(s) for machines and/or operating systems; system name(s)	

Only the first three items are required for all implementations; other information may be completed as appropriate in meeting the requirement for full identification.

The terms Name and Version should be interpreted appropriately to correspond with a supplier's terminology (e.g. Type, Series, Model).

A.3.2 Protocol summary

Protocol version	1.0
Addenda implemented (if applicable)	
Amendments implemented	
Have any exception items been required (see A.2.3)?	No <input type="checkbox"/> Yes <input type="checkbox"/> (The answer Yes means that the implementation does not conform to this Standard)
Date of Statement	

A.3.3 General

Item	Question/feature	References	Status	N/A	Support
A1	Behaviour as CTMI-detect PINX for ANF-CTMI		o.1		Yes [] No []
A2	Behaviour as Home PINX for ANF-CTMI		o.1		Yes [] No []
A3	Behaviour as Visitor PINX for ANF-CTMI		o.1		Yes [] No []
A4	Behaviour as Transit PINX for ANF-CTMI		o.1		Yes [] No []
A5	Behaviour as Originating PINX		o.1		Yes [] No []
A6	Behaviour as Incoming Gateway PINX		o.1		Yes [] No []
A7	Behaviour as Rerouteing PINX for ANF-CTMI		c.1		m: Yes [] o: Yes [] No []

c.1: if A5 or A6 then mandatory else if A1 then optional

A.3.4 Procedures

Item	Question/feature	References	Status	N/A	Support
B1	Support of ECMA-143 and ECMA-165 procedures at a Rerouteing PINX	6.2.1	A7:m	[]	m: Yes []
B2	Support of ECMA-143 and ECMA-165 procedures at a CTMI-detect PINX	6.2.2	A1:m	[]	m: Yes []
B3	Support of ECMA-165 procedures at a Home PINX	6.2.3	A2:m	[]	m: Yes []
B4	Support of ECMA-143 and ECMA-165 procedures at a Visitor PINX	6.2.4	A3:m	[]	m: Yes []
B5	Support of ECMA-143 and ECMA-165 procedures at a Transit PINX	6.2.5	A4:m	[]	m: Yes []
B6	Signalling procedures at a Rerouteing PINX	6.5.1	A7:m	[]	m: Yes []
B7	Signalling procedures at a CTMI-detect PINX	6.5.2	A1:m	[]	m: Yes []
B8	Signalling procedures at a Home PINX	6.5.3.1 6.5.3.2	A2:m	[]	m: Yes []
B9	Signalling procedures at a Visitor PINX	6.5.4	A3:m	[]	m: Yes []
B10	Additional procedures at a Home PINX for Call Forwarding Unconditional	6.5.3.3	A2:o	[]	o: Yes [] No []

A.3.5 Coding

Item	Question/feature	References	Status	N/A	Support
C1	Receipt of ctmiDivert invoke APDU and sending of return result and return error APDUs	6.3	A7:m	[]	m: Yes []
C2	Sending of ctmiInform invoke APDU	6.3	A7:m	[]	m: Yes []
C3	Sending of ctmiEnquiry invoke APDU and receipt of return result and return error APDUs	6.3	A1:m	[]	m: Yes []
C4	Sending of ctmiDivert invoke APDU and receipt of return result and return error APDUs	6.3	A1:m	[]	m: Yes []
C5	Receipt of ctmiEnquiry invoke APDU and sending of return result and return error APDUs	6.3	A2:m	[]	m: Yes []
C6	Receipt of ctmiInform invoke APDU	6.3	A3:m	[]	m: Yes []

A.3.6 Timers

Item	Question/feature	References	Status	N/A	Support
D1	Support of Timer T1	6.9.1	A1:m	[]	m: Yes [] Value [. . . .]
D2	Support of Timer T2	6.9.2	A1:m	[]	m: Yes [] Value [. . . .]

A.3.7 Interactions between ANF-CTMI and SS-CFU

Item	Question/feature	References	Status	N/A	Support
E1	Support of SS-CFU		o		Yes [] No []
E2	Interactions at CTMI-detect PINX	6.8.3.1	c.1	[]	m:Yes []

c.1: if E1 and A1 then mandatory, else N/A

A.3.8 Interactions between ANF-CTMI and SS-CO

Item	Question/feature	References	Status	N/A	Support
F1	Support of SS-CO		o		Yes [] No []
F2	Interactions at Rerouteing PINX	6.8.10.1	c.1	[]	m:Yes []

c.1: if F1 and A7 then mandatory, else N/A

A.3.9 Interactions between ANF-CTMI and SS-DNDO

Item	Question/feature	References	Status	N/A	Support
G1	Support of SS-DNDO		o		Yes [] No []
G2	Interactions at Rerouteing PINX	6.8.12.1	c.1	[]	m:Yes []

c.1: if G1 and A7 then mandatory, else N/A

A.3.10 Interactions between ANF-CTMI and SS-CI

Item	Question/feature	References	Status	N/A	Support
H1	Support of SS-CI		o		Yes [] No []
H2	Interactions at Rerouteing PINX	6.8.13.1	c.1	[]	m:Yes []

c.1: if H1 and A7 then mandatory, else N/A

A.3.11 Interactions between ANF-CTMI and SS-AOC

Item	Question/feature	References	Status	N/A	Support
I1	Support of SS-AOC		o		Yes [] No []
I2	Interactions at Rerouteing PINX	6.8.16.1	c.1	[]	m:Yes []

c.1: if I1 and A7 then mandatory, else N/A





Annex B

(informative)

Examples of Message Sequences

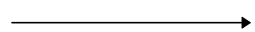
This annex describes some typical message flows for ANF-CTMI. The following conventions are used in the figures of this annex:

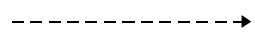
1. The following notation is used:

	Basic call message containing ANF-CTMI information
	Basic call message without ANF-CTMI information
	Call independent signalling connection message containing ANF-CTMI information
	Call independent signalling connection message without ANF-CTMI information
	Symbolic primitive without ANF-CTMI information
xxx.inv	Invoke APDU for operation xxx
xxx.res	Return result APDU for operation xxx
xxx.err	Return error APDU for operation xxx

2. The figures show messages exchanged via Protocol Control between PINXs involved in ANF-CTMI. Only messages relevant to ANF-CTMI are shown.
3. Only the relevant information content (e.g. remote operation APDUs, notifications, information elements) is listed below each message name. The Facility and Notification indicator information elements containing remote operation APDUs and notifications are not explicitly shown. Information with no impact on ANF-CTMI is not shown.

B.1 Example message sequences for normal operation of ANF-CTMI

Figure B.1 shows an example of normal operation of ANF-CTMI.

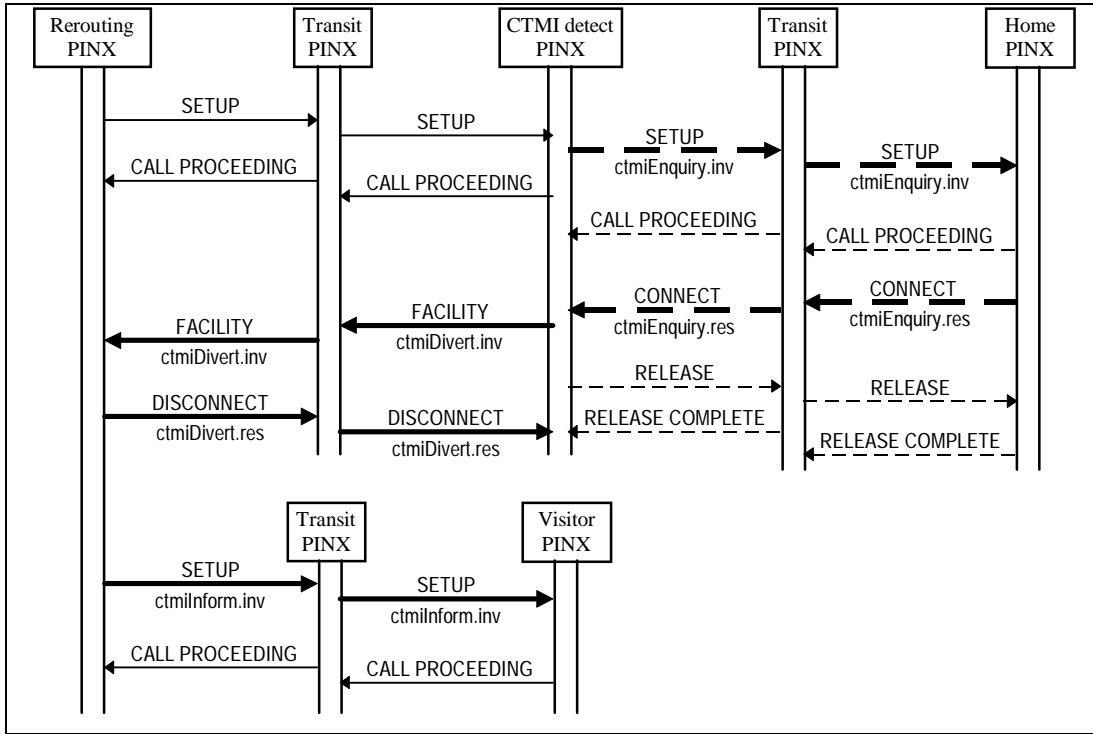

Figure B.1 - Example of normal operation of ANF-CTMI

Figure B.2 shows an example of ANF-CTMI when the Rerouting fails and the CTMI-detect PINX performs forward switching to the Visitor PINX.

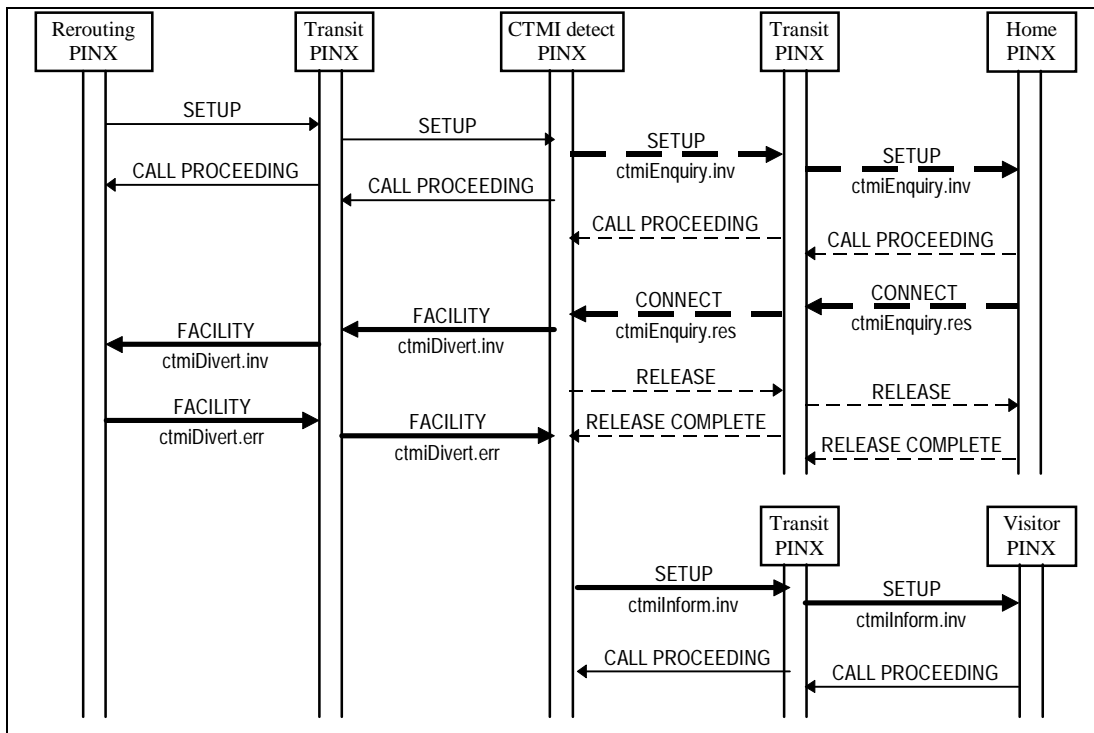

Figure B.2 - Example of forward switching by the CTMI-detect PINX

B.2 Examples of unsuccessful operation of ANF-CTMI

B.2.1 CTM user unknown in Home PINX

Figure B.3 shows an example of unsuccessful operation of ANF-CTMI due to CTM user unknown.

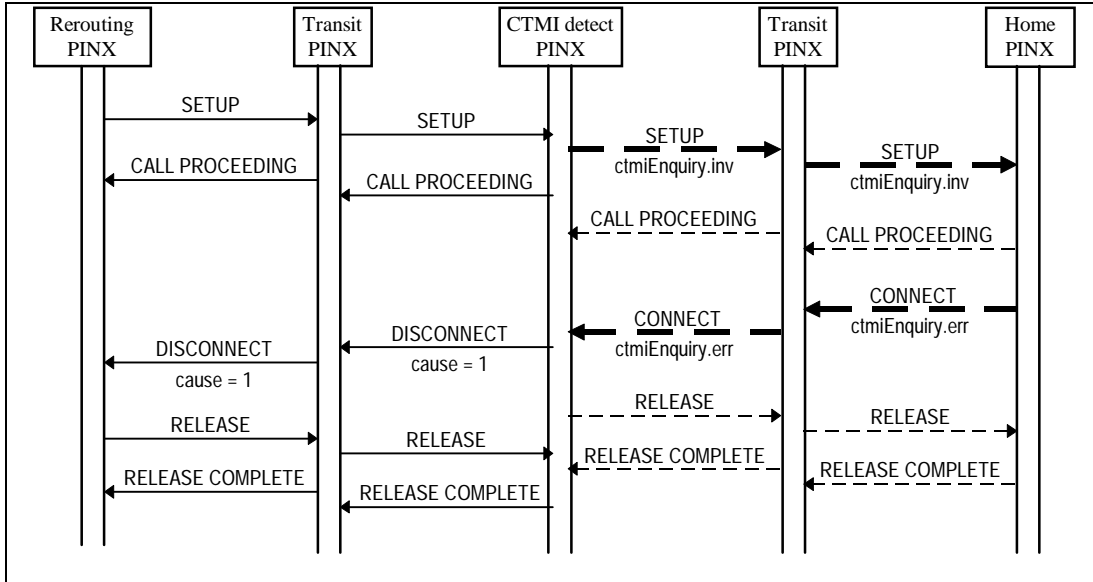

Figure B.3 - Example of ANF-CTMI failure due to CTM user unknown

B.2.2 CTM user's location not known in Home PINX

Figure B.4 shows an example of unsuccessful operation of ANF-CTMI due to CTM user's location not known.

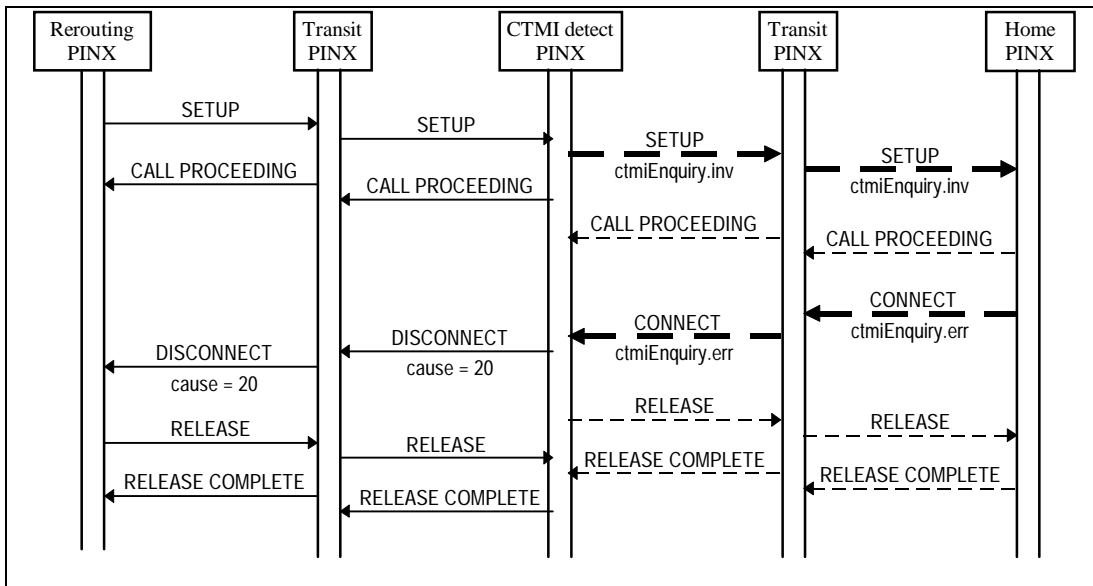

Figure B.4 - Example of ANF-CTMI failure due to CTM user's location not known

B.2.3 Collision with location update detected by Visitor PINX

Figure B.5 shows an example of unsuccessful operation of ANF-CTMI due to collision with location update.

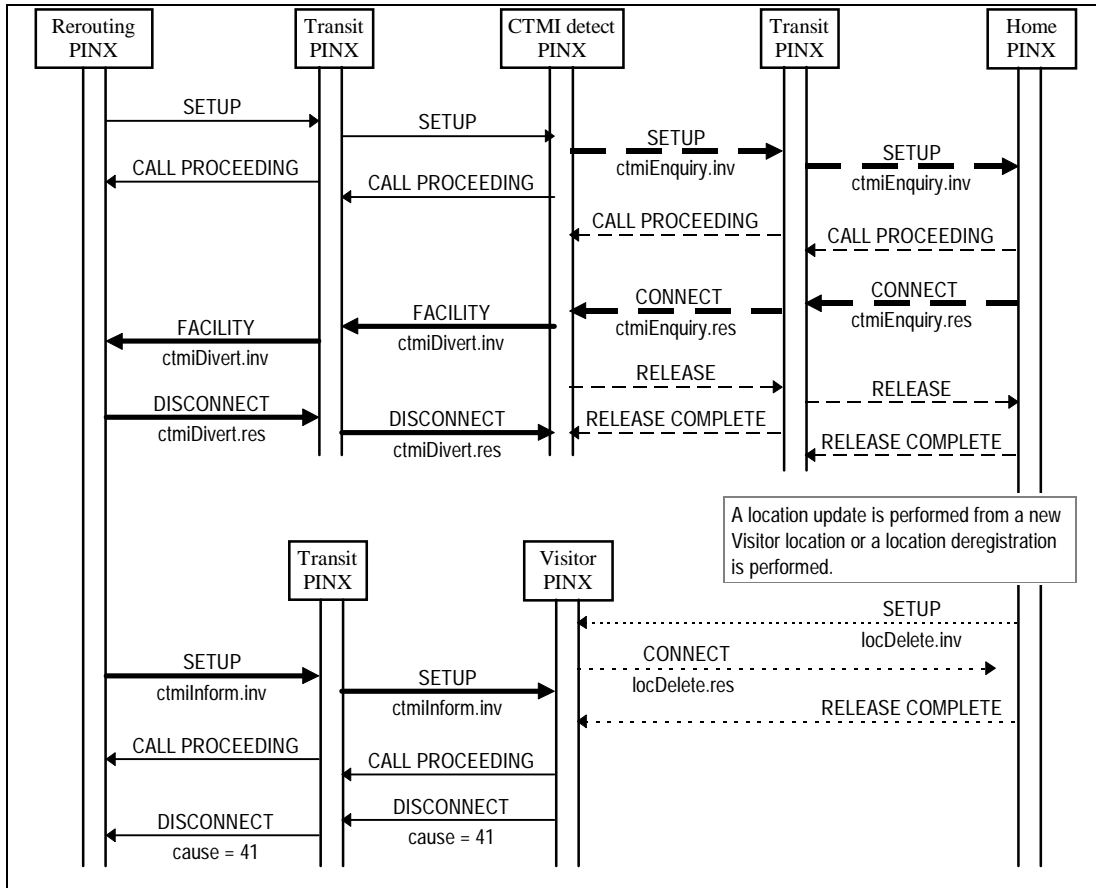

Figure B.5 - Example of ANF-CTMI failure due to collision with location update

Annex C

(informative)

Specification and Description Language (SDL) Representation of Procedures

The diagrams in this annex use the Specification and Description Language defined in ITU-T Rec. Z.100 (1993).

Each diagram represents the behaviour of an ANF-CTMI Supplementary Service Control entity at a particular type of PINX. In accordance with the protocol model described in ECMA-165, the Supplementary Service Control entity uses, via the Co-ordination Function, the services of Generic Functional Procedures Control and Basic Call Control.

Where an output symbol represents a primitive to the Co-ordination Function, and that primitive results in a message being sent, the output symbol bears the name of the message and any remote operations APDU(s) or notification(s) contained in that message. In the case of a message specified in ECMA-143, basic call actions associated with the sending of that message are deemed to occur.

Where an input symbol represents a primitive from the Co-ordination Function, and that primitive is the result of a message being received, the input symbol bears the name of the message and any remote operations APDU(s) or notification(s) contained in that message. In the case of a message specified in ECMA-143, basic call actions associated with the receipt of that message are deemed to have occurred.

The following abbreviations are used:

inv.	invoke APDU
res.	return result APDU
err.	return error APDU
rej.	reject APDU

C.1 SDL representation of ANF-CTMI at the Rerouteing PINX

Figure C.1 shows the behaviour of an ANF-CTMI Supplementary Service Control entity within the Rerouteing PINX.

Input signals from the right and output signals to the right represent primitives to and from the Co-ordination Function in respect of messages sent and received.

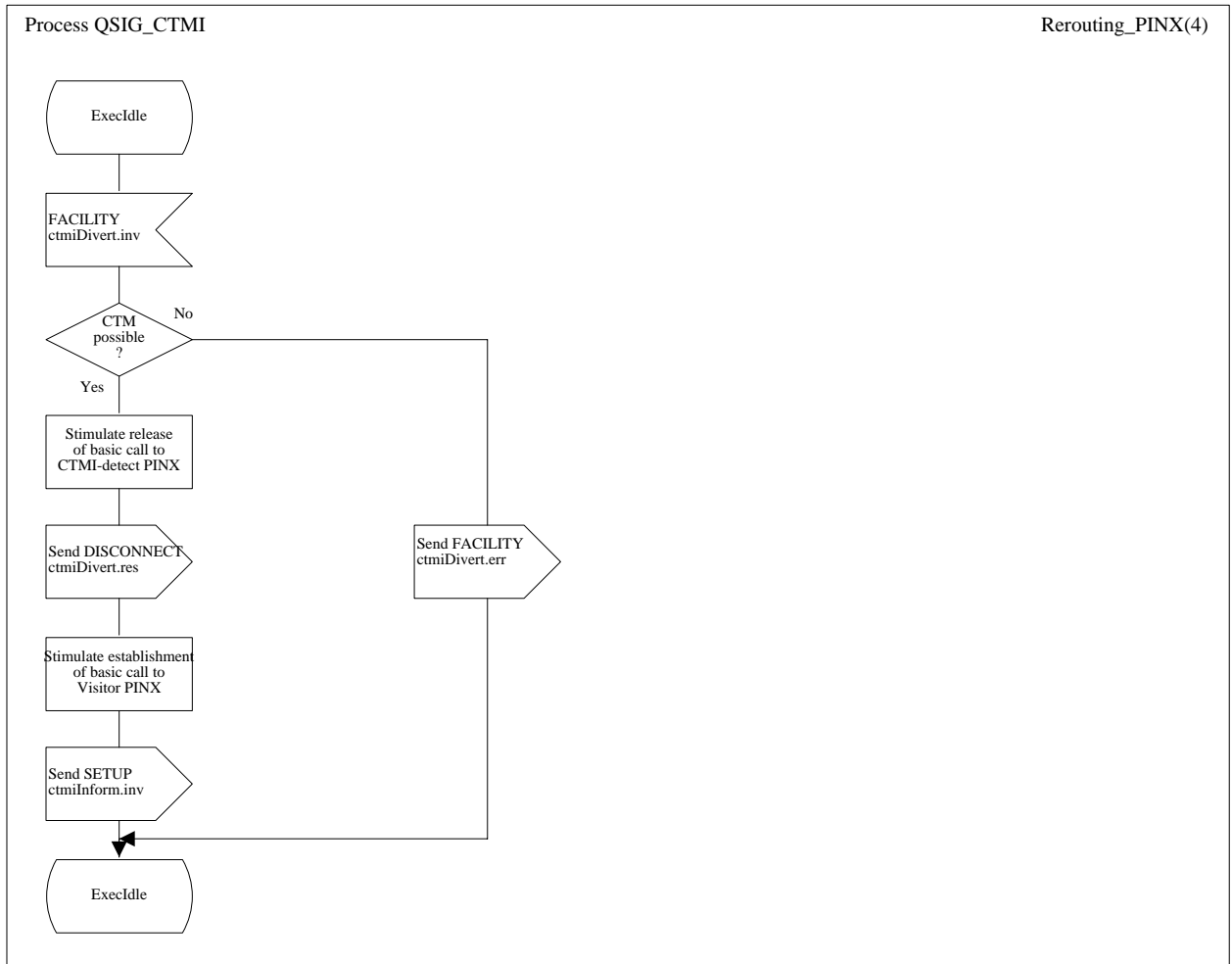

Figure C.1 - SDL representation of ANF-CTMI at the Rerouteing PINX

C.2 SDL representation of ANF-CTMI at the CTMI-detect PINX

Figure C.2 shows the behaviour of an ANF-CTMI entity within the CTMI-detect PINX.

Input signals from the right and output signals to the right represent primitives to and from the Co-ordination Function in respect of messages sent and received. Also protocol timer expiry is indicated by an input signal from the right.

Input signals from the left represent internal stimuli.

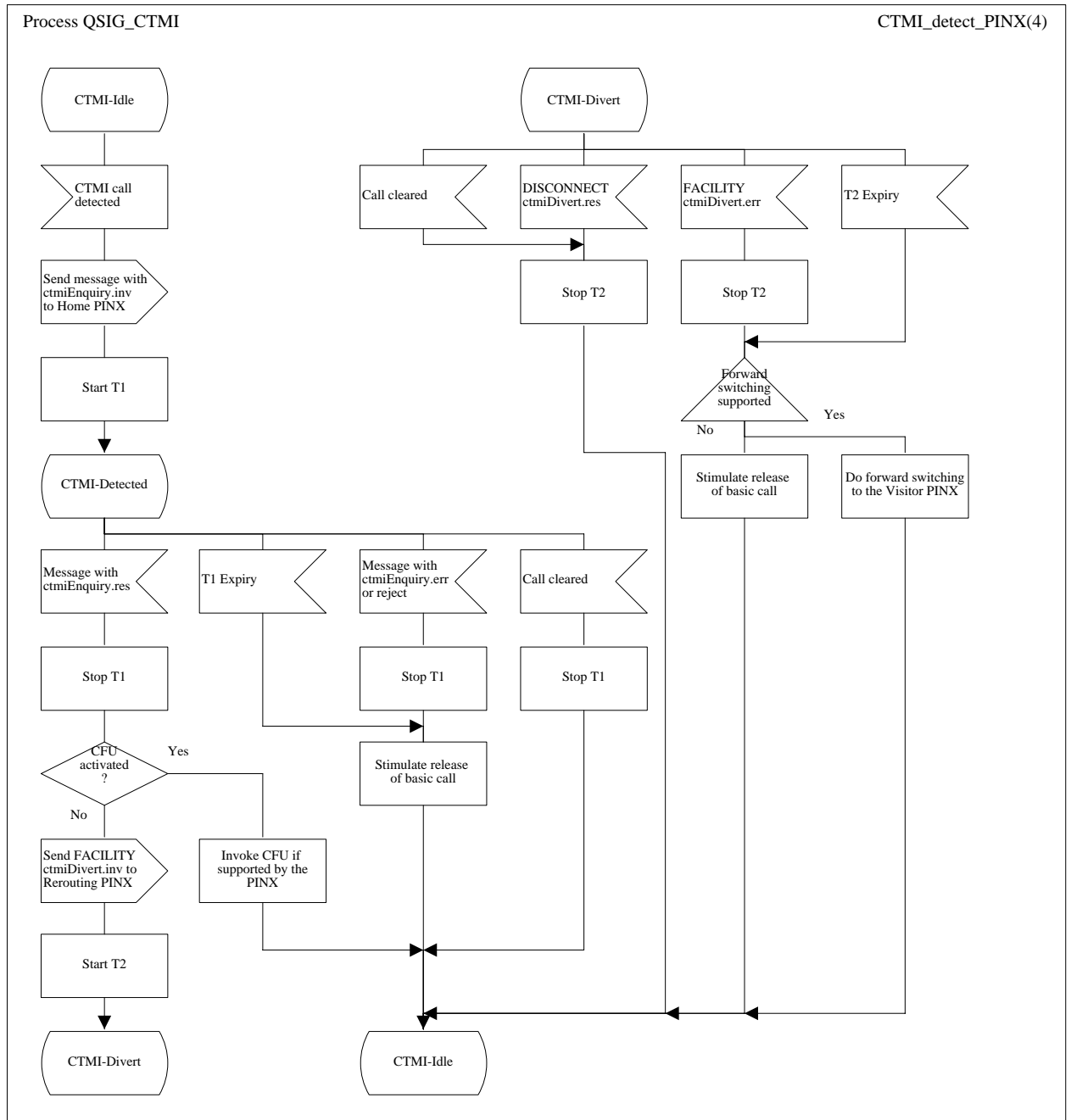

Figure C.2 - SDL representation of ANF-CTMI at the CTMI-detect PINX

C.3 SDL representation of ANF-CTMI at the Home PINX

Figure C.3 shows the behaviour of an ANF-CTMI entity within the Home PINX.

Input signals from the right and output signals to the right represent primitives to and from the Co-ordination Function in respect of messages sent and received.

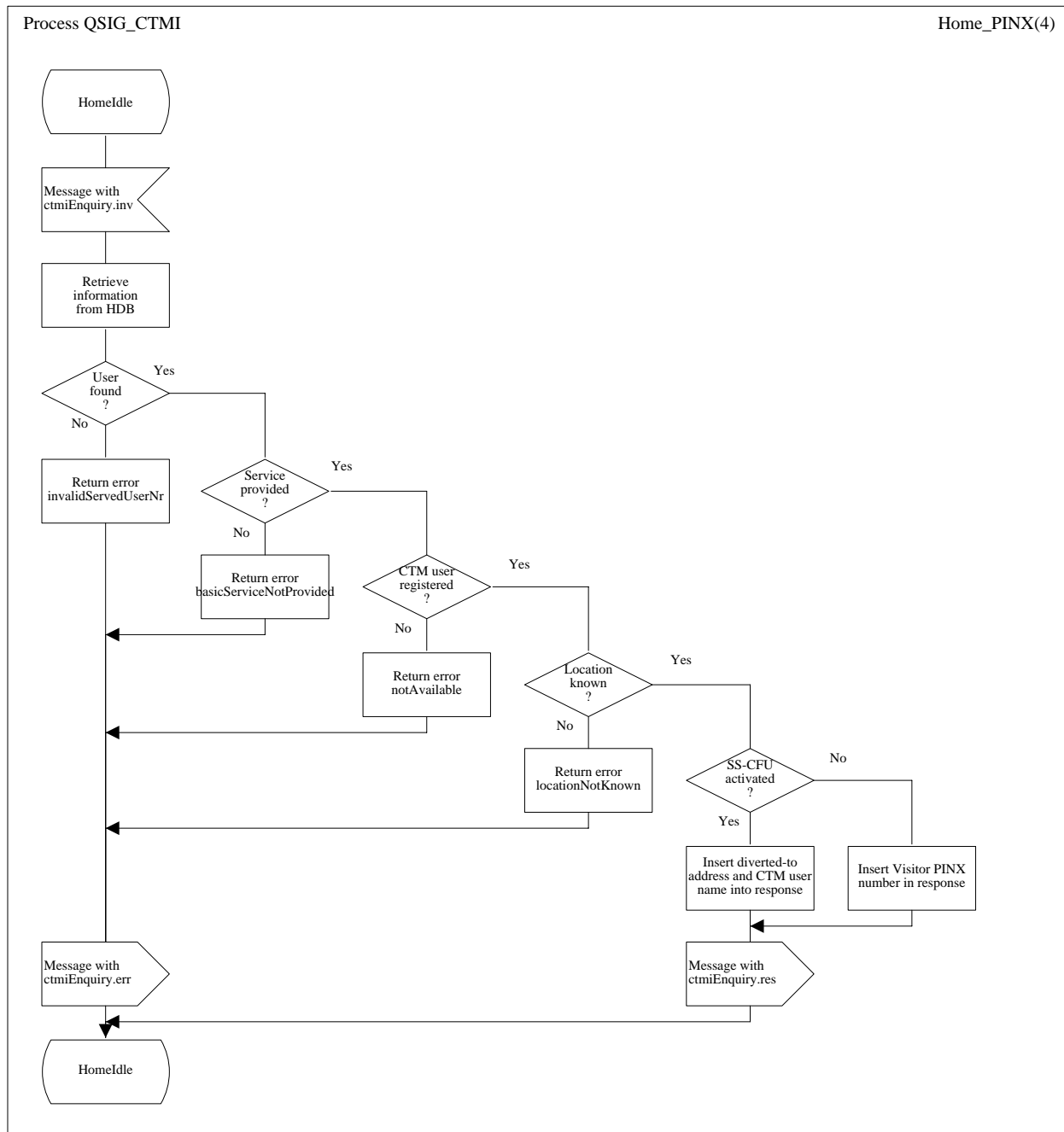

Figure C.3 - SDL representation of ANF-CTMI at the Home PINX

C.4 SDL representation of ANF-CTMI at the Visitor PINX

Figure C.4 shows the behaviour of an ANF-CTMI entity within the Visitor PINX.

Input signals from the right and output signals to the right represent primitives to and from the Co-ordination Function in respect of messages sent and received.

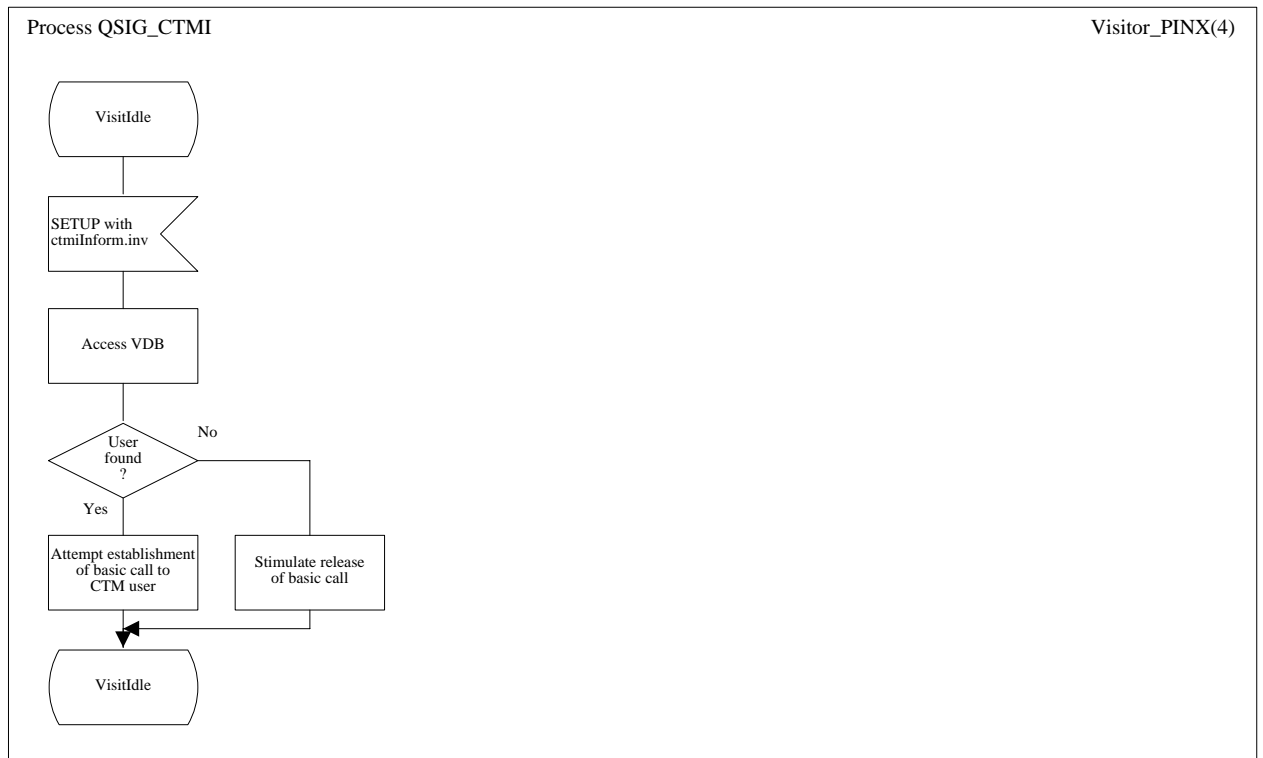

Figure C.4 - SDL representation of ANF-CTMI at the Visitor PINX

Annex D

(informative)

Bibliography

ETS 300 694 Private Integrated Services Network (PISN);
Cordless Terminal Mobility (CTM);
Call handling additional network features;
Service description (1996)

Annex E

(informative)

Imported ASN.1 definitions

Table E.1 is an extract from module General-Error-List in ITU-T recommendation Q.950.

Table E.1 - Imported ASN.1 definitions General-Error-List

notAvailable	ERROR ::= 3 -- is an indication that the user has subscribed to this service but the requested -- service is not available combined with the basic service or the other services -- (e.g. operation).
invalidServedUserNumber	ERROR ::= 6 -- is an indication that the requested service cannot be performed because of the -- usage of an invalid served user number.
basicServiceNotProvided	ERROR ::= 8 -- is an indication that the service request is directed to a Basic Service which is not -- provided (e.g. this return error value is used in cases where a supplementary service -- is to be invoked with a SETUP message but indicating the wrong Basic Service).

Table E.2 is an extract from module Addressing-Data-Elements in ISO/IEC 11582.

Table E.2 - Imported ASN.1 definitions Addressing-Data-Elements

PresentedNumberScreened	::= CHOICE	
	{ presentationAllowedNumber	[0] IMPLICIT NumberScreened,
	presentationRestricted	[1] IMPLICIT NULL,
	numberNotAvailableDueToInterworking	[2] IMPLICIT NULL,
	presentationRestrictedNumber	[3] IMPLICIT NumberScreened }
NumberScreened	::= SEQUENCE	
	{ PartyNumber,	
	ScreeningIndicator }	
Address	::= SEQUENCE	
	{ PartyNumber,	
	PartySubaddress OPTIONAL }	
PartyNumber	::= CHOICE	
	{ unknownPartyNumber	[0] IMPLICIT NumberDigits,
	-- the numbering plan is the default numbering plan of the network.	
	-- It is recommended that this value is used.	
	publicPartyNumber	[1] IMPLICIT PublicPartyNumber,
	-- the numbering plan is according to Recs. E.163 and E.164.	
	dataPartyNumber	[3] IMPLICIT NumberDigits,
	-- not used, value reserved.	
	telexPartyNumber	[4] IMPLICIT NumberDigits,
	-- not used, value reserved.	
	privatePartyNumber	[5] IMPLICIT PrivatePartyNumber,
	nationalStandardPartyNumber	[8] IMPLICIT NumberDigits }
	}	
PublicPartyNumber	::= SEQUENCE	
	{ publicTypeOfNumber	PublicTypeOfNumber,
	publicNumberDigits	NumberDigits }
PrivatePartyNumber	::= SEQUENCE	
	{ privateTypeOfNumber	PrivateTypeOfNumber,
	privateNumberDigits	NumberDigits }
NumberDigits	::= NumericString (SIZE(1..20))	
PublicTypeOfNumber	::= ENUMERATED	
	{ unknown	(0),
	-- if used number digits carry prefix indicating type of number	
	-- according to national recommendations	
	internationalNumber	(1),
	nationalNumber	(2),
	networkSpecificNumber	(3),
	-- not used, value reserved.	
	subscriberNumber	(4),
	abbreviatedNumber	(6) }
	-- valid only for called party number at the outgoing access,	
	-- network substitutes appropriate number	
PrivateTypeOfNumber	::= ENUMERATED	
	{ unknown	(0),
	level2RegionalNumber	(1),
	level1RegionalNumber	(2),
	pISNSpecificNumber	(3),
	localNumber	(4),
	abbreviatedNumber	(6) }

Table E.2 - Imported ASN.1 definitions Addressing-Data-Elements (concluded)

PartySubaddress	::= CHOICE { UserSpecifiedSubaddress, -- not recommended NSAPSubaddress } -- according to Rec. X.213
UserSpecifiedSubaddress	::= SEQUENCE { SubaddressInformation, oddCountIndicator BOOLEAN OPTIONAL } -- used when the coding of subaddress is BCD
NSAPSubaddress	::= OCTET STRING (SIZE(1..20)) -- specified according to Rec. X.213. Some networks may -- limit the subaddress value to some other length, e.g. 4 octets
SubaddressInformation	::= OCTET STRING (SIZE(1..20)) -- specified according to user requirements. Some networks may limit the -- subaddress value to some other length, e.g. 4 octets
ScreeningIndicator	::= ENUMERATED { userProvidedNotScreened (0), -- number was provided by a remote user terminal equipment, -- and has been screened by a network that is not the local public -- or local private network. userProvidedVerifiedAndPassed (1), -- number was provided by a remote user terminal equipment -- (or by a remote private network), and has been screened -- by the local public or local private network. userProvidedVerifiedAndFailed (2), -- not used, value reserved. networkProvided (3) } -- number was provided by public or local private network

Printed copies can be ordered from:

ECMA

114 Rue du Rhône
CH-1204 Geneva
Switzerland

Fax: +41 22 849.60.01

Internet: documents@ecma.ch

Files can be downloaded from our FTP site, [ftp.ecma.ch](ftp://ftp.ecma.ch), logging in as **anonymous** and giving your E-mail address as **password**. This Standard is available from library **ECMA-ST** as a compacted, self-expanding file in MSWord 6.0 format (file E215-DOC.EXE) and as an Acrobat PDF file (file E215-PDF.PDF). File E215-EXP.TXT gives a short presentation of the Standard.

Our web site, <http://www.ecma.ch>, gives full information on ECMA, ECMA activities, ECMA Standards and Technical Reports.

ECMA

**114 Rue du Rhône
CH-1204 Geneva
Switzerland**

This Standard ECMA-215 is available free of charge in printed form and as a file.

See inside cover page for instructions