

**Standard** ECMA-362

1<sup>st</sup> Edition / December 2004

**NFCIP-1 - Protocol Test  
Methods**

**Standard**



Standard  
ECMA-362

1<sup>st</sup> Edition / December 2004

---

**NFCIP-1 - Protocol Test  
Methods**

---



## Brief history

In 2002, Ecma International formed Task Group 19 of Technical Committee 32 to specify Near Field Communication (NFC) signal interfaces and protocols. The NFC devices are wireless closely coupled devices communicating at 13,56 MHz.

The General Assembly of December 2002 adopted Near Field Communication Interface and Protocol-1 (NFCIP-1) as Standard ECMA-340.

This Ecma standard specifies protocol tests for ECMA-340 and complements ECMA-356, which specifies the RF interface tests for ECMA-340.

This Ecma Standard has been adopted by the General Assembly of December 2004.

---



## Table of contents

<b>1</b>	<b>Scope</b>	<b>1</b>
<b>2</b>	<b>Conformance</b>	<b>1</b>
<b>3</b>	<b>References</b>	<b>1</b>
<b>4</b>	<b>Notational conventions</b>	<b>1</b>
4.1	Representation of numbers	1
4.2	Names	1
4.3	Test report	1
<b>5</b>	<b>Definitions</b>	<b>1</b>
5.1	Activation in Active communication Mode	1
5.2	Activation in Passive communication Mode	1
5.3	Active communication Mode	1
5.4	Operating volume	2
5.5	Passive communication Mode	2
5.6	Single Device Detection (SDD)	2
5.7	Scenario	2
5.8	Test commands	2
<b>6</b>	<b>Acronyms and abbreviations</b>	<b>3</b>
<b>7</b>	<b>General description</b>	<b>4</b>
7.1	Apparatus for Testing	4
7.1.1	Generating the I/O character timing in reception mode	4
7.1.2	Measuring and monitoring the RF I/O protocol	4
7.1.3	Test scenario and report	4
7.1.4	RFU bits	4
7.1.5	General rules	4
<b>8</b>	<b>Target test methods</b>	<b>4</b>
8.1	Apparatus for testing the Target (Target-test-apparatus)	4
8.2	List of protocol test methods related to ECMA-340	5
8.3	Activation in Passive communication Mode at 212 and 424 kbps	6
8.3.1	Activation time	6
8.3.2	Frame format	6
8.3.3	SDD at 212 and 424 kbps	6
8.4	Activation in Active communication Mode	7

8.4.1	RF Collision Avoidance	7
8.5	Logical operation of the Target Transport Protocol	8
8.5.1	Handling of ATR_REQ	8
8.5.2	Handling of PSL_REQ	9
8.5.3	Handling of DEP_REQ Information PDUs	10
8.5.4	Handling of DEP_REQ Information PDUs with the "more information" bit set to ONE	11
8.5.5	Handling of DEP_REQ supervisory PDU's with timeout bit set to ONE	14
8.5.6	Handling of DEP_REQ supervisory PDUs with timeout bit set to ZERO	15
8.5.7	Handling of DSL_REQ	16
8.5.8	Handling of RLS_REQ	17
8.5.9	Handling of WUP_REQ (Active communication Mode Only)	18
<b>9</b>	<b>Initiator test methods</b>	<b>21</b>
9.1	Apparatus for testing the Initiator (Initiator-test-apparatus)	21
9.1.1	Initiator test apparatus concept	21
9.1.2	Protocol activation procedure for Passive communication Mode at 106 kbps	21
9.1.3	Protocol activation procedures for Passive communication Mode at 212 and 424 kbps	21
9.1.4	Protocol activation procedures for Active communication Mode	22
9.2	List of protocol test methods for Initiators	22
9.3	Activation in Passive communication Mode at 212 and 424kbps	23
9.3.1	Frame format	23
9.3.2	SDD at 212 and 424 kbps	23
9.4	Activation in Active communication Mode	24
9.4.1	Initial RF Collision Avoidance	24
9.4.2	Response RF Collision Avoidance with time jitter n=0	24
9.5	Logical operation of the Transport Protocol	24
9.5.1	Handling of ATR_RES	24
9.5.2	Handling of PSL_RES	25
9.5.3	Handling of DEP_RES Information PDUs	26
9.5.4	Handling of DEP_RES Information PDU's with more information bit set to ONE	28
9.5.5	Handling of DEP_RES supervisory PDU's with timeout bit set to ONE	30
9.5.6	Handling of DEP_RES supervisory PDUs with timeout bit set to ZERO	31
9.5.7	Handling of DSL_RES	32
9.5.8	Handling of RLS_RES	33
<b>Annex A (normative)</b>	<b>Test report template for Target tests</b>	<b>35</b>
<b>Annex B (normative)</b>	<b>Test report template for Initiator tests</b>	<b>39</b>



## 1 Scope

---

This Ecma Standard specifies protocol test methods for ECMA-340 in addition to those specified in ECMA-356.

## 2 Conformance

---

In addition to conforming to ECMA-356, implementations of ECMA-340 shall pass all normative tests and requirements specified herein; test results shall be recorded using Annex A and Annex B of this Ecma Standard.

## 3 References

---

The following are normative references for the purpose of this Standard:

ECMA-340	Near Field Communication - Interface and Protocol (NFCIP-1)
ECMA-356	NFCIP-1 - RF Interface Test Methods
ISO/IEC 10373-6	Identification cards -- Test methods -- Part 6: Proximity cards

## 4 Notational conventions

---

### 4.1 Representation of numbers

The following conventions and notations apply in this document unless otherwise stated.

- Letters and digits in parentheses represent numbers in hexadecimal notation.
- The setting of bits is denoted by ZERO or ONE.
- Numbers in binary notation and bit patterns are represented by strings of digits 0 and 1 shown with the most significant bit to the left. Within such strings, X may be used to indicate that the setting of a bit is not specified within the string.

### 4.2 Names

The names of basic elements, e.g. specific fields, are written with a capital initial letter.

### 4.3 Test report

The test report includes the number of passed tests versus the total number of tests, the number of different samples and the date of the tests, see Annexes A and B.

## 5 Definitions

---

### 5.1 Activation in Active communication Mode

Flow to activate the DUT in Active communication Mode as defined in ECMA-340, which includes initialisation and protocol activation.

### 5.2 Activation in Passive communication Mode

Flow to activate the DUT in Passive communication Mode as defined in ECMA-340, which includes initialisation and protocol activation.

### 5.3 Active communication Mode

In the Active communication Mode scheme, as defined in ECMA-340, both the Initiator and the Target use their own RF field to enable the communication.

## 5.4 Operating volume

A volume with a field strength of at least  $H_{\min}$  and not exceeding  $H_{\max}$  generated by a NFC device at manufacturer specified positions.

## 5.5 Passive communication Mode

The Initiator is generating the RF field and the Target responds to an Initiator command in a load modulation scheme as defined in ECMA-340.

## 5.6 Single Device Detection (SDD)

SDD is an algorithm used by the initiator to detect one out of several Targets in its RF field.

## 5.7 Scenario

A scenario is a protocol and application specific sequence test operations. Scenario description tables list all individual test operations.

A horizontal line in a scenario description table indicates that the device shall be reset to initial conditions.

## 5.8 Test commands

Commands defined for dedicated functional behaviour on an implemented system according to ECMA-340. The PDUs that are actually used in these commands shall be recorded in the test report (see Annex A and Annex B).

Definitions valid for all test commands:

xx PNI

The following test commands are specified based on PDUs specified in ECMA-340:

A(ACK) <sub>xx</sub>	DEP_REQ or DEP_RES PDU coded as ACK/NACK PDU with ACK/NACK bit set to ZERO and PNI set to xx.
A(NACK) <sub>xx</sub>	DEP_REQ or DEP_RES PDU coded as ACK/NACK PDU with ACK/NACK bit set to ONE and PNI set to xx.
S(A)	DEP_REQ or DEP_RES PDU coded as Supervisory PDU (as defined in ECMA-340) with the Timeout bit set to ZERO. No PNI is used for this command.
S(TO)	DEP_REQ or DEP_RES PDU coded as Supervisory PDU (as defined in ECMA-340) with the Timeout bit set to ONE. No PNI is used for this command.
TEST_COMMAND1 <sub>xx</sub>	Default Test command, it is a DEP_REQ frame coded as information PDU with "More Information" bit set to ZERO (no chaining) and the PNI set to xx. The Initiator or the target-test-apparatus sends this PDU.
TEST_RESPONSE1 <sub>xx</sub>	Response to TEST_COMMAND1 (DEP_RES) with the PNI set to xx.
TEST_COMMAND2 <sub>xx</sub>	Test command used for tests of the chaining procedure. This command forces the counterpart (either Initiator or Target) to use chaining in the next DEP_REQ. This command is a DEP_REQ or DEP_RES frame, for an Initiator or Target respectively, with its "More Information" bit set to ZERO and it uses the same PDU as TEST_COMMAND1, but this PDU has different data.
TEST_COMMAND3B <sub>xx</sub>	This command marks the beginning of a DEP_REQ or DEP_RES frame, for an Initiator or Target respectively, with its "More Information" bit set to ONE and the PNI set to xx.
TEST_COMMAND3n <sub>xx</sub>	This command is sent after TEST_COMMAND3B and before TEST_COMMAND3E. The lower case <i>n</i> represents a number ranging

	from 0 to 9. This command has the "More Information" bit set to ONE and the PNI set to xx.
TEST_COMMAND3E <sub>xx</sub>	This command marks the end of the chaining procedure and is a DEP_REQ or DEP_RES frame, for an Initiator or Target respectively, with the "More Information" bit set to ZERO and the PNI set to xx.
TEST_RESPONSE3 <sub>xx</sub>	is the response to the chaining command. Shall be a DEP_REQ or DEP_RES frame, for an Initiator or Target respectively, with the "More Information" bit set to ZERO and the PNI set to xx.
TEST_COMMAND4 <sub>xx</sub>	Test command used for tests dealing with frame waiting time. The Initiator sends this command and forces the Target to use a Supervisory PDU with the timeout bit set to ONE and the PNI set to xx.
TEST_RESPONSE4 <sub>xx</sub>	is the response to TEST_COMMAND4. It is a DEP_RES with the "More Information" bit set to ZERO and the PNI set to xx. It may be the same as TEST_RESPONSE1.

## 6 Acronyms and abbreviations

---

ATR_REQ	ATtribute Request command as defined in ECMA-340
ATR_RES	Response to the ATR_REQ
CRC	Cyclic Redundancy Check as defined in Annex A of ECMA-340
~CRC	CRC as defined above with all bits inverted
DEP_REQ	Data Exchange Protocol Request as defined in ECMA-340
DEP_RES	Response to the Data Exchange Protocol Request
DID	Device ID as defined in ECMA-340
DSL_REQ	DeSeLect Request command as defined in ECMA-340
DSL_RES	Response to the DSL_REQ
DUT	Device Under Test
fc	Frequency of operating field (carrier frequency) as defined in ECMA-340
Hmax	Maximum field strength of the Initiator antenna field as defined in ECMA-340
Hmin	Minimum field strength of the Initiator antenna field as defined in ECMA-340
HThreshold	Defined in ECMA-340
ID	Identification number
LT	Lower Tester the Target-emulation part of the Initiator-Test-apparatus
Mute	No response within a specified timeout
PDU	Protocol Data Unit as defined in ECMA-340
PNI	Package Number Information as defined in ECMA-340
POL_REQ	POLLing Request command as defined in ECMA-340
POL_RES	Response to the Polling Request
PSL_REQ	Parameter SeLect Request command as defined in ECMA-340
PSL_RES	Response to the PSL_REQ
RF	Radio Frequency
RFU	Reserved for Future Use
RLS_REQ	ReLease Request command as defined in ECMA-340

RLS_RES	Response to the RLS_REQ
SDD	Single Device Detection as defined in ECMA-340
T <sub>d</sub>	The delay between the end of the Request frame and the start of the first time slot for SDD at 212 and 424 kbps (equals 512 × 64/fc)
T <sub>s</sub>	The period of one time slot (equals 256 × 64/fc)
TCM	Test control message
UT	Upper Tester, the master part of the Initiator-Test-apparatus

## 7 General description

---

### 7.1 Apparatus for Testing

*NOTE*

*The test-apparatus may require information about the implemented protocol and functionality. These parameters shall be recorded in the test report.*

This clause is valid for Initiator and Target tests.

Although this Standard does not define dedicated test circuit for timing measurements and to check the correctness of the framing, influence of such circuit shall be avoided.

#### 7.1.1 Generating the I/O character timing in reception mode

The target-test-apparatus and the LT shall be able to generate the I/O bit stream according to ECMA-340. All timing parameters (e.g. start bit length, guard time, bit width, request guard time, start of frame width, end of frame width) shall be set to any value within the defined ranges of ECMA-340. The limits shall be tested according ECMA-356.

#### 7.1.2 Measuring and monitoring the RF I/O protocol

The target-test-apparatus and the LT shall be able to measure the timing of the logical low and high states of the incoming demodulated data.

#### 7.1.3 Test scenario and report

Testing of the DUT as defined in this document and requires a test scenario to be executed. This test scenario contains a protocol and application specific sequence.

The result of the test scenario shall be documented in a test report as defined in Annexes A and B.

#### 7.1.4 RFU bits

A test shall fail and the DUT declared non-compliant in case an RFU field is not set to its default value.

#### 7.1.5 General rules

The following rules apply:

An Initiator (Target test apparatus) always sends a request whereas a Target (LT) sends a response.

A response must follow a request.

If the PNIs for the TEST\_RESPONSE<sub>n</sub> and TEST\_COMMAND<sub>n</sub> are the same, then TEST\_COMMAND<sub>n</sub> is correct.

## 8 Target test methods

---

### 8.1 Apparatus for testing the Target (Target-test-apparatus)

The Target-test-apparatus tests the DUT by emulating an Initiator.

The Target-test-apparatus shall execute the initialisation and protocol activation and perform data exchange commands.

## 8.2 List of protocol test methods related to ECMA-340

To test Targets performing initialisation and SDD in Passive communication Mode at 106 kbps the PICC test methods of ISO/IEC 10373-6 must be executed.

To test Targets performing initialisation and SDD in Passive communication Mode at 212 and 424 kbps the test methods listed in table 1 must be executed.

Table 1 — Activation in Passive communication Mode at 212 and 424 kbps

Clause	Test method Name	Corresponding requirement	
		Base standard	Clause(s)
8.3.1	Activation time	ECMA-340	11.2.2.3
8.3.2	Frame format	ECMA-340	11.2.2.2
8.3.3	SDD at 212 and 424 kbps	ECMA-340	11.2.2.3 11.2.2.4

To test Targets performing initialisation in Active communication Mode the test method in table 2 must be executed.

Table 2 — Activation in Active communication Mode

Clause	Test method Name	Corresponding requirement	
		Base standard	Clause(s)
8.4.1	RF Collision Avoidance	ECMA-340	11.1.2

To test Targets using the transport protocol the test methods listed in table 3 must be executed.

Table 3 — Logical operation of the Transport Protocol

Clause	Test method Name	Corresponding requirement	
		Base standard	Clause(s)
8.5.1	Handling of ATR_REQ	ECMA-340	12.5.1.3
8.5.2	Handling of PSL_REQ	ECMA-340	12.5.3.3
8.5.3	Handling of DEP_REQ Information PDUs	ECMA-340	12.6.1.2
8.5.4	Handling of DEP_REQ Information PDUs with the "more information" bit set to ONE	ECMA-340	12.6.1.3
8.5.5	Handling of DEP_REQ supervisory PDUs with timeout bit set to ONE	ECMA-340	12.6.1.3
8.5.6	Handling of DEP_REQ supervisory PDU's with timeout bit set to ZERO	ECMA-340	12.6.1.3
8.5.7	Handling of DSL_REQ	ECMA-340	12.7.1.3
8.5.8	Handling of RLS_REQ	ECMA-340	12.7.2.3

### 8.3 Activation in Passive communication Mode at 212 and 424 kbps

#### 8.3.1 Activation time

The purpose of this test is to verify that the Target responds with to a POL\_REQ with a POL\_RES within two seconds after power up (see ECMA-340 clause 11.2.2.3).

##### 8.3.1.1 Procedure

Repeat steps a) to e) for the data rates of 212 and 424 kbps.

- a) Place the DUT into the operating volume.
- b) Generate an RF-field between the limits  $H_{min}$  and  $H_{max}$  and verify that the field strength does not influence the test results.
- c) Send a POL\_REQ command frame with TSN is set to 0 at the selected data rate.
- d) If there is no POL\_RES received after  $T_d$  and  $T_s$  are passed send the POL\_REQ again. Repeat this step until a response from the DUT is received.
- e) Measure the timing between RF-on and the beginning of the 1<sup>st</sup> response of the DUT. If the DUT responds in less than two seconds, the test is PASS otherwise it is FAIL.

##### 8.3.1.2 Test report

The test report shall indicate whether the DUT behaves correctly for both data rates.

#### 8.3.2 Frame format

The purpose of this test is to determine the frame formats at 212 and 424 kbps are correct (see ECMA-340 clause 11.2.2.2).

##### 8.3.2.1 Procedure

Repeat steps a) to d) for the data rates of 212 and 424 kbps.

- a) Place the DUT into the operating volume.
- b) Generate an RF-field between the limits  $H_{min}$  and  $H_{max}$  and verify that the field strength does not influence the test results.
- c) Send the POL\_REQ command frame at the selected data rate.
- d) Verify the correct framing of the response from the DUT.

##### 8.3.2.2 Test report

The test report shall indicate whether the DUT behaves correctly for both data rates and shall include results for the following characteristics:

Characteristic	Expected result
Preamble	minimum 48 bits all logical ZEROs
SYNC	1 <sup>st</sup> byte is 'B2' 2 <sup>nd</sup> byte is '4D'
value of the length byte	'12'
CRC bytes	according to ECMA-340, Annex A

#### 8.3.3 SDD at 212 and 424 kbps

The purpose of this test is to determine the correct response to the POL\_REQ (see ECMA-340 clause 11.2.2.4).

##### 8.3.3.1 Procedure

Repeat steps a) to f) for the data rates of 212 and 424 kbps.

- a) Place the DUT into the operating volume.
- b) Generate an RF-field between the limits  $H_{\min}$  and  $H_{\max}$  and verify that the field strength does not influence the test results.
- c) Send a POL\_REQ command frame with TSN is set to 0 at the selected data rate.
- d) Record the time between POL\_REQ and POL\_RES. If the DUT does not respond in the last time slot available repeat step c).
- e) Analyse the content of the response.
- f) Increase the TSN to the next allowed value and repeat step a) to e) until the maximum TSN value is reached.

### 8.3.3.2 Test report

The test report shall indicate whether the DUT behaves correctly for both data rates and shall include results for the following characteristics:

Characteristic	Expected result
1st byte of the payload	'01'
2nd byte of the payload	'01'
3rd byte of the payload	'FE'
time between end of POL_REQ and end of POL_RES	$T_d + (TSN + 1) * T_s$

## 8.4 Activation in Active communication Mode

### 8.4.1 RF Collision Avoidance

The purpose of this test is to determine the behaviour of the DUT in Active communication Mode during RF Collision Avoidance (see ECMA-340 clause 11.1.2).

#### 8.4.1.1 Procedure

Repeat steps a) to e) for the data rates of 106, 212 and 424 kbps.

- a) Place the DUT into the operating volume.
- b) Generate an RF-field between the limits  $H_{\min}$  and  $H_{\max}$  and verify that the field strength does not influence the test results.
- c) Send a valid ATR\_REQ command frame at the selected data rate and switch off the RF afterwards.
- d) Measure the time between RF-off of the Target test-apparatus and RF-on of the DUT.
- e) Repeat steps a) to d) until all randomly generated number of time periods are met and count the number of retries necessary.

#### 8.4.1.2 Test report

The test report shall indicate whether the DUT behaves correctly for all data rates.

Characteristic	Expected result
$T_{ADT}$	minimum $768/f_c$ maximum $2559/f_c$
$T_{RFW}$	n times $512/f_c$

## 8.5 Logical operation of the Target Transport Protocol

### 8.5.1 Handling of ATR\_REQ

The purpose of this test is to determine the correct handling of the ATR\_REQ of the DUT (see ECMA-340 clause 12.5.1.3.2).

#### 8.5.1.1 Procedure

Repeat steps a) to e) for the data rates of 106, 212 and 424 kbps and for both Active and Passive communication Modes.

- a) Place the DUT into the operating volume.
- b) Generate an RF-field between the limits  $H_{min}$  and  $H_{max}$  and verify that the field strength does not influence the test results.
- c) Perform activation selected according at the selected data rate and follow the rules for Collision avoidance in Active communication mode.
- d) Apply the test scenario T 1.
- e) Analyse if the response from the DUT are according to scenario T 1.

#### *Scenario T 1 — ATR\_REQ*

Target-test-apparatus		DUT
TEST_COMMAND1 <sub>00</sub>	→	
	←	Mute
ATR_REQ	→	
	←	ATR_RES
ATR_REQ	→	
	←	ATR_RES
ATR_REQ (~CRC)	→	
	←	Mute
ATR_REQ	→	
	←	ATR_RES
TEST_COMMAND1 <sub>00</sub>	→	
	←	TEST_RESPONSE1 <sub>00</sub>
ATR_REQ	→	
	←	Mute
TEST_COMMAND1 <sub>01</sub>	→	
	←	TEST_RESPONSE1 <sub>01</sub>



### 8.5.1.2 Test report

The test report shall indicate whether the DUT behaves correctly for all data rates and communication modes.

### 8.5.2 Handling of PSL\_REQ

The purpose of this test is to determine the correct PSL handling of the DUT (see ECMA-340 clause 12.5.3.3.2).

#### 8.5.2.1 Procedure

Repeat steps a) to f) for the data rates of 106, 212 and 424 kbps and for both Active and Passive communication Modes.

- a) Place the DUT into the operating volume.
- b) Turn on a field between the limits  $H_{min}$  and  $H_{max}$  and verify that the field strength does not influence the test results.
- c) Perform initialisation and protocol activation in the selected communication mode and data rate.
- d) Send an ATR\_REQ and receive ATR\_RES.
- e) Apply the test scenario T 2.
- f) Check the response from the DUT is according to scenario T 2.

#### Scenario T 2 — PSL\_REQ

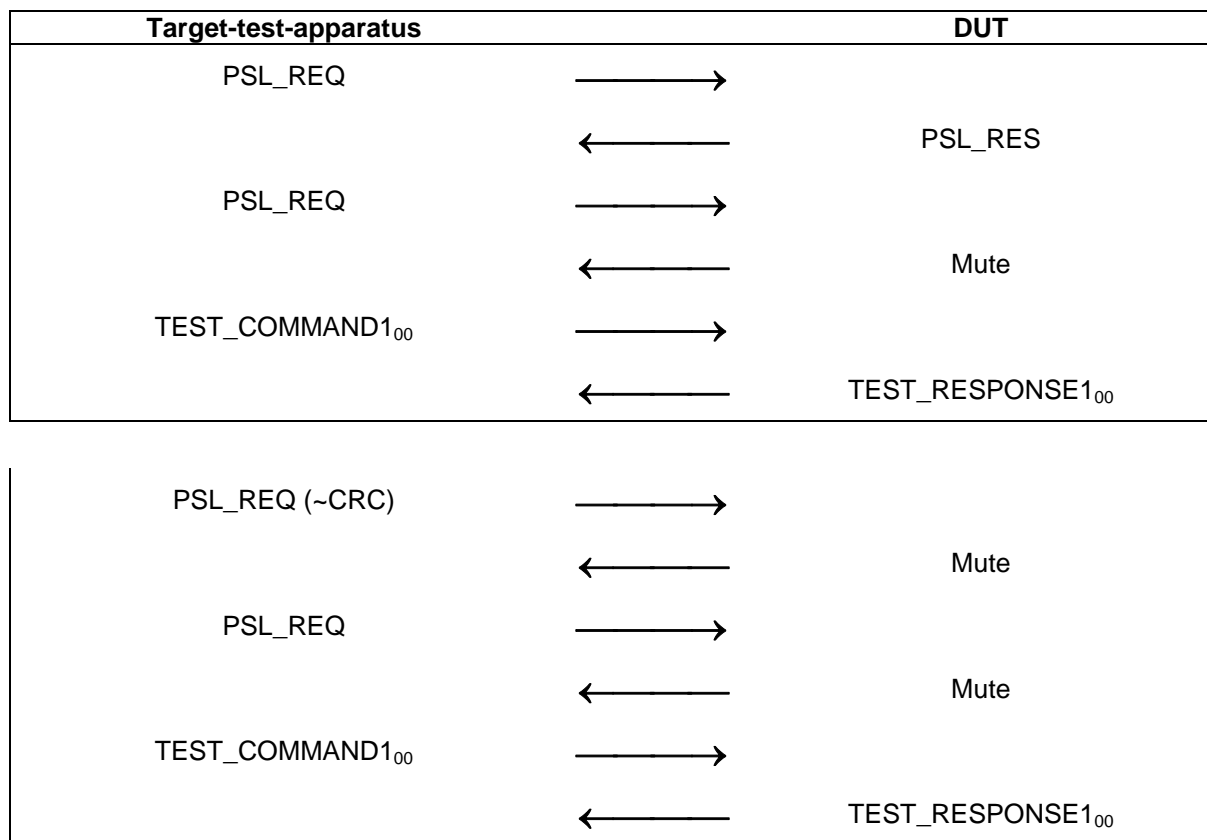

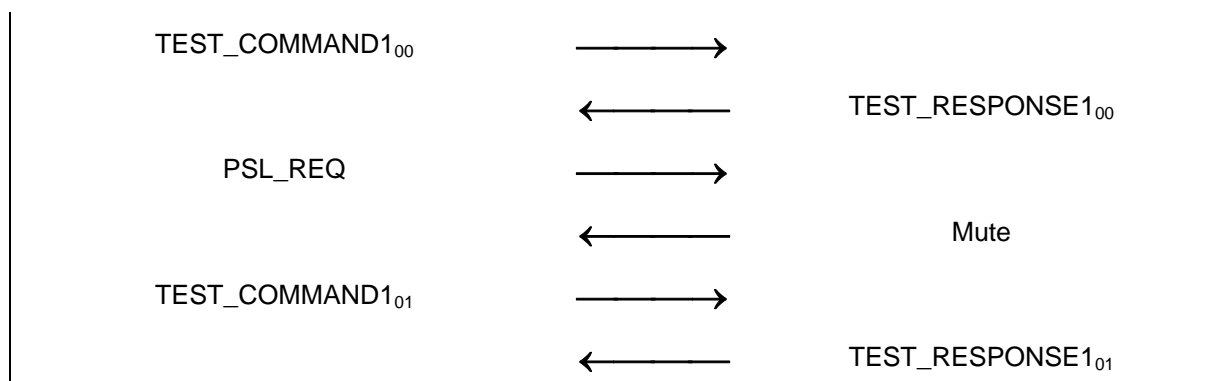

### 8.5.2.2 Test report

The test report shall indicate whether the DUT behaves correctly for all data rates and communication modes.

### 8.5.3 Handling of DEP\_REQ Information PDUs

The purpose of this test is to determine the correct handling of the DEP\_REQ information PDU of the DUT (see ECMA-340 clause 12.6.1.3).

#### 8.5.3.1 Procedure

Repeat steps a) to f) for the data rates of 106, 212 and 424 kbps and for both Active and Passive communication Modes.

- Place the DUT into the operating volume.
- Turn on a field between the limits  $H_{min}$  and  $H_{max}$  and verify that the field strength does not influence the test results.
- Perform activation in the selected communication mode and data rate.
- Send an ATR\_REQ and receive the ATR\_RES from the DUT.
- Execute scenario T 3 followed by scenario T 4.
- Check if the response and the PNIs from the DUT are according to the scenarios.

*Scenario T 3 — DEP\_REQ information PDU, correct transaction*

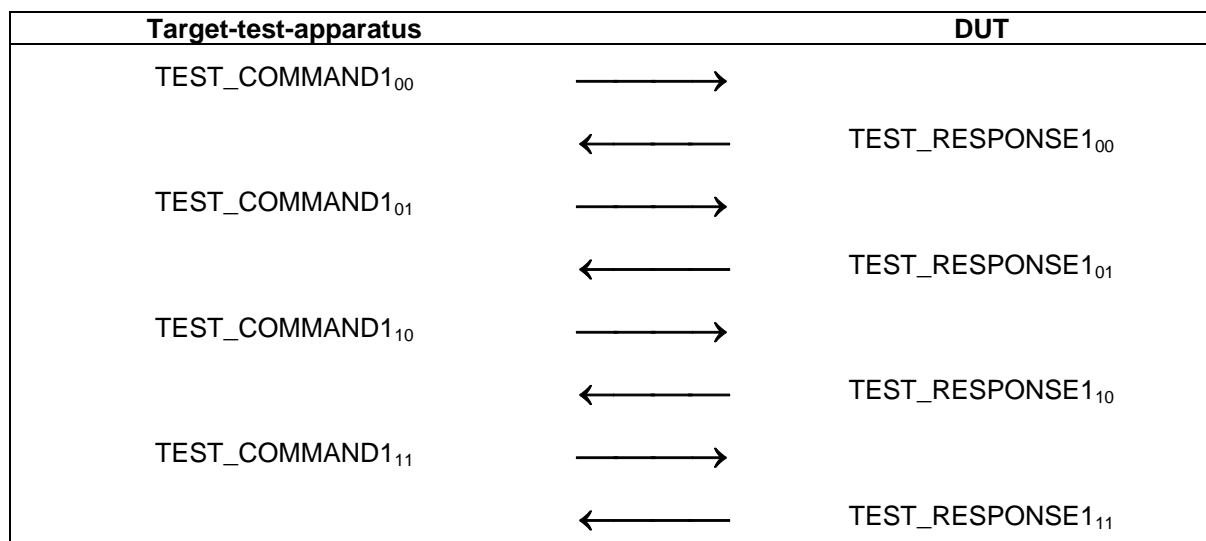

*Scenario T 4 — DEP\_REQ information PDU, erroneous transaction*

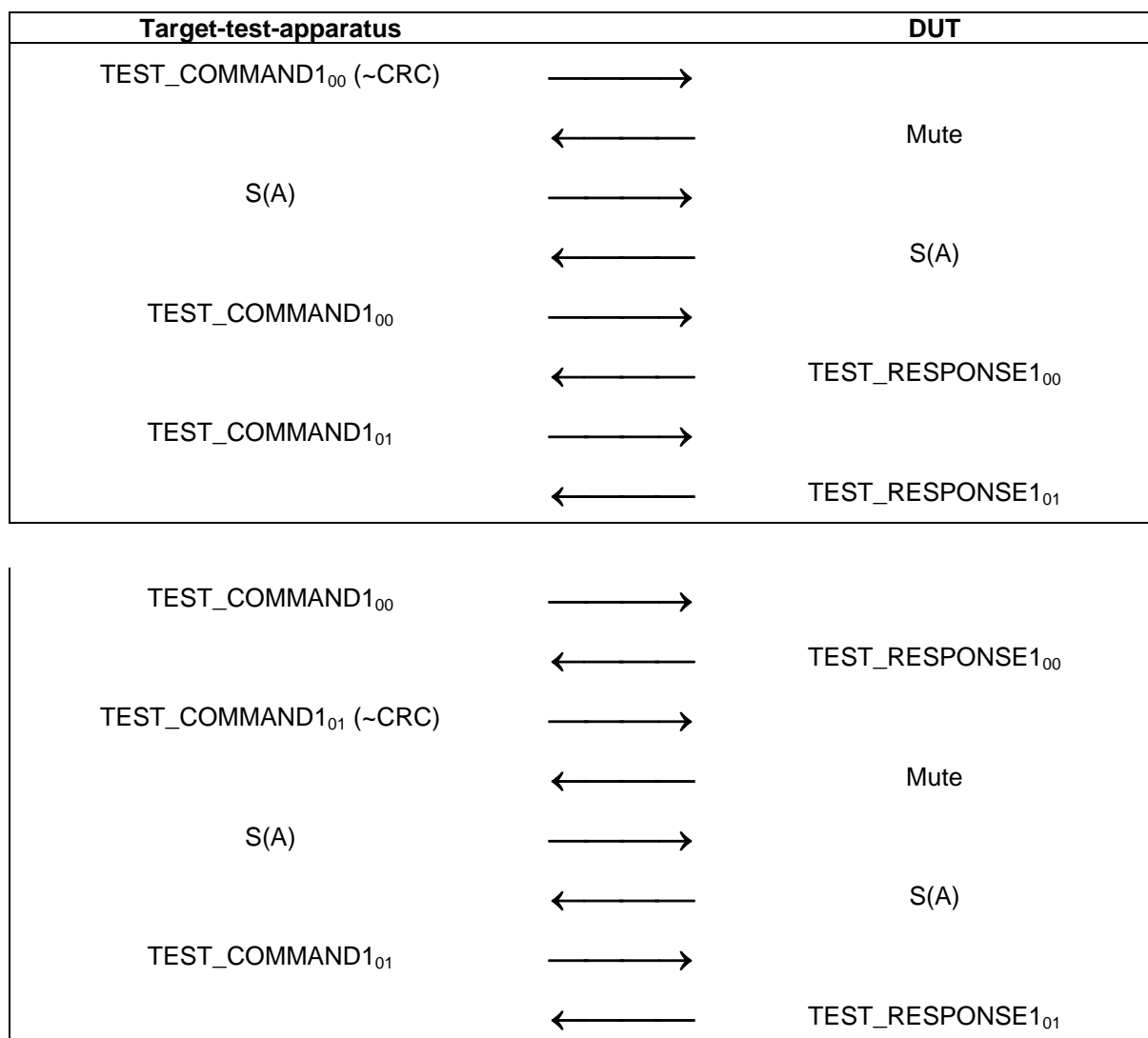

### 8.5.3.2 Test report

The test report shall indicate whether the DUT behaves correctly for all data rates and communication modes for both scenarios.

### 8.5.4 Handling of DEP\_REQ Information PDUs with the "more information" bit set to ONE

The purpose of this test is to determine the correct handling of the DEP\_REQ information PDU with the "more information" bit set to ONE (see ECMA-340 clause 12.6.1.3).

#### 8.5.4.1 Procedure

Repeat steps a) to f) for the data rates of 106, 212 and 424 kbps and for both Active and Passive communication Modes.

- a) Place the DUT into the operating volume.
- b) Turn on a field between the limits  $H_{min}$  and  $H_{max}$  and verify that the field strength does not influence the test results.
- c) Perform activation in the selected communication mode and data rate.
- d) Send an ATR\_REQ and receive the ATR\_RES from the DUT.

- e) Execute scenario T 5 followed scenario T 6.
- f) Check if the response and the PNIs from the DUT are according to the test scenarios.

*Scenario T 5 — DEP\_REQ information PDU with more information bit set; correct transaction*

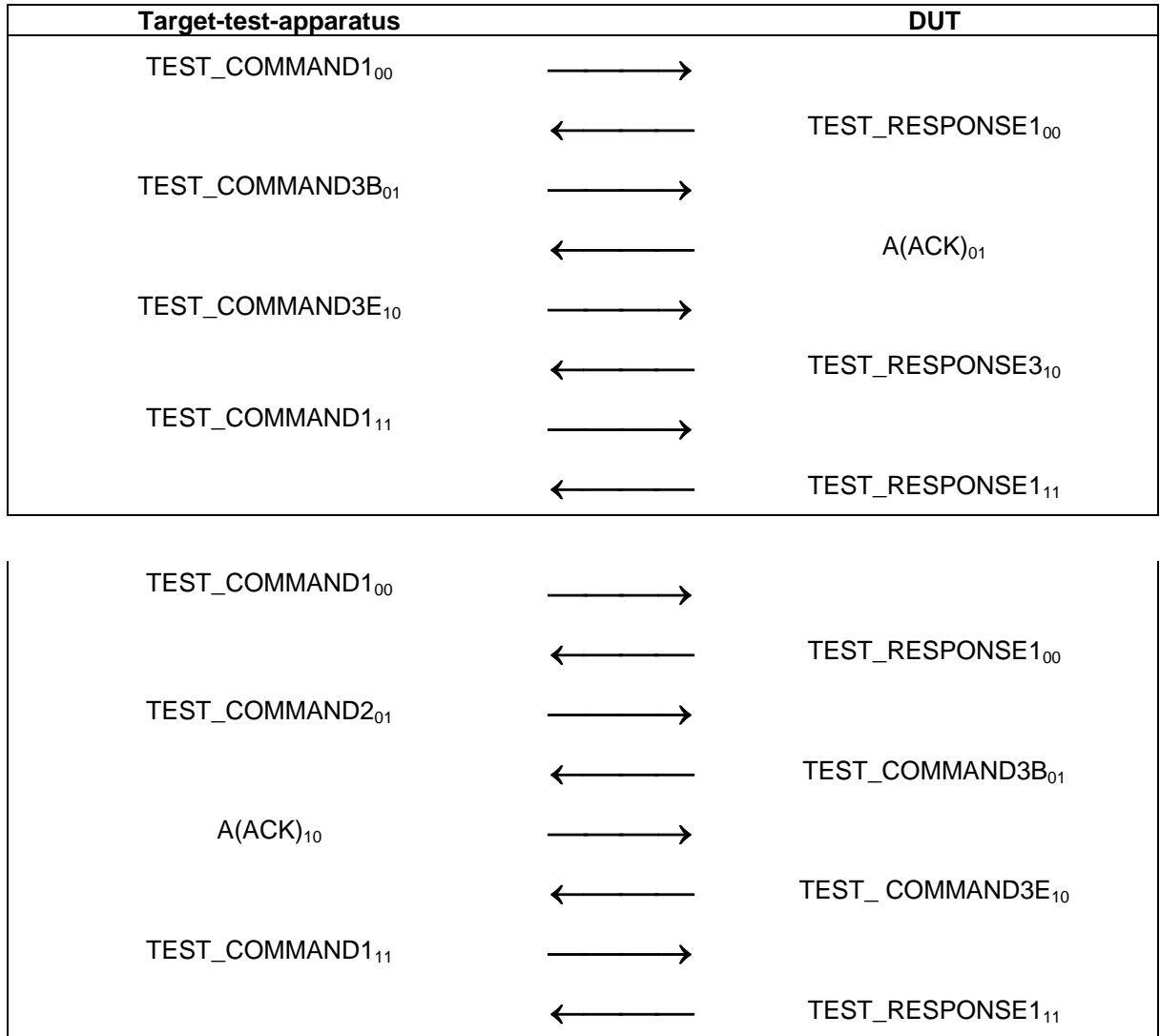

Scenario T 6 — DEP\_REQ information PDU with more information bit set, erroneous transaction

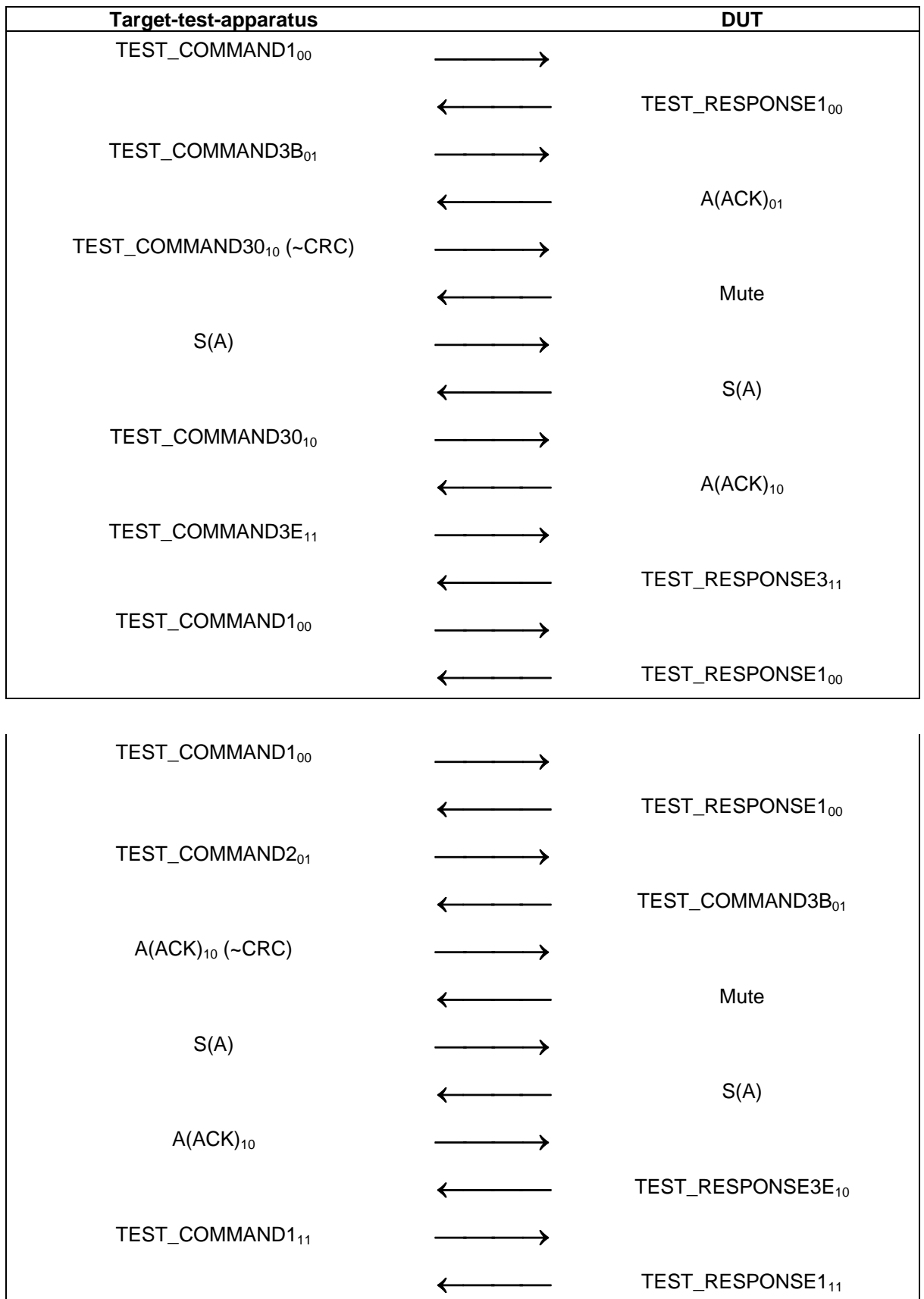

### 8.5.4.2 Test report

The test report shall indicate whether the DUT behaves correctly for all data rates and communication modes.

### 8.5.5 Handling of DEP\_REQ supervisory PDU's with timeout bit set to ONE

The purpose of this test is to determine the correct handling of the DEP\_REQ with supervisory PDU with timeout bit set to ONE (see ECMA-340 clause 12.6.1.3).

#### 8.5.5.1 Procedure

Repeat steps a) to f) for the data rates of 106, 212 and 424 kbps and for both Active and Passive communication Modes.

- a) Place the DUT into the operating volume.
- b) Turn on a field between the limits  $H_{min}$  and  $H_{max}$  and verify that the field strength does not influence the test results.
- c) Perform activation in the selected communication mode and data rate.
- d) Send an ATR\_REQ and receive the ATR\_RES from the DUT.
- e) Execute scenario T 7 followed by scenario T 8.
- f) Check if the response and the PNIs from the DUT are according to scenarios.

*Scenario T 7 — DEP\_REQ supervisory PDU with timeout bit set to ONE; correct transaction*

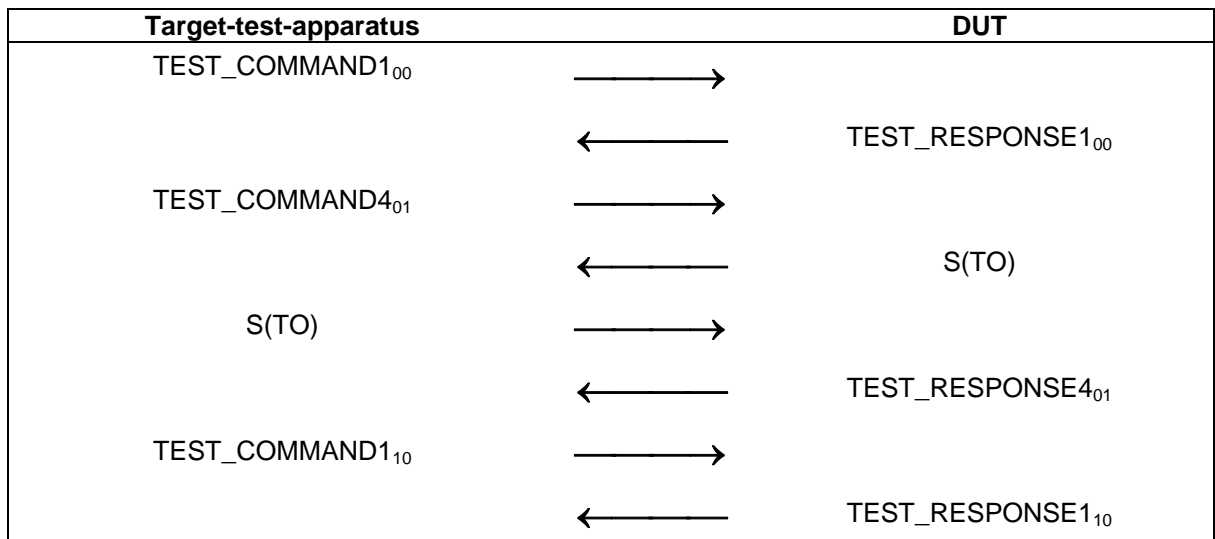

*Scenario T 8 — DEP\_REQ supervisory PDU, timeout bit set, erroneous transaction*

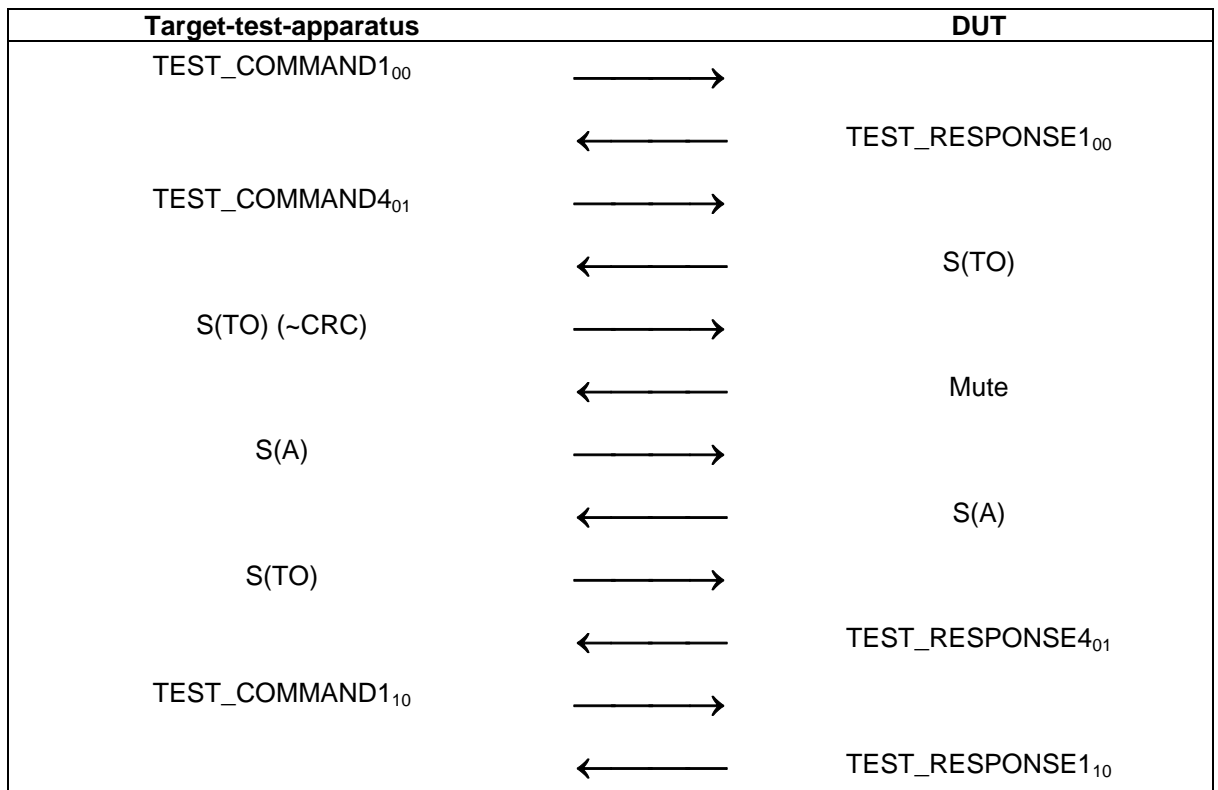

### 8.5.5.2 Test report

The test report shall indicate whether the DUT behaves correctly for all data rates and both communication modes

### 8.5.6 Handling of DEP\_REQ supervisory PDUs with timeout bit set to ZERO

The purpose of this test is to determine the correct handling of the DEP\_REQ supervisory PDU with the timeout bit set to ZERO (see ECMA-340 clause 12.6.1.3).

#### 8.5.6.1 Procedure

Repeat steps a) to f) for the data rates of 106, 212 and 424 kbps and for both Active and Passive communication Modes.

- Place the DUT into the operating volume.
- Turn on a field between the limits  $H_{min}$  and  $H_{max}$  and verify that the field strength does not influence the test results.
- Perform activation in the selected communication mode and data rate.
- Send an ATR\_REQ and receive the ATR\_RES from the DUT.
- Execute scenario T 9 followed by scenario T 10.
- Check if the response and the PNIs from the DUT are according to the scenarios.

*Scenario T 9 — DEP\_REQ supervisory PDU, timeout bit not set to ZERO, correct transaction*

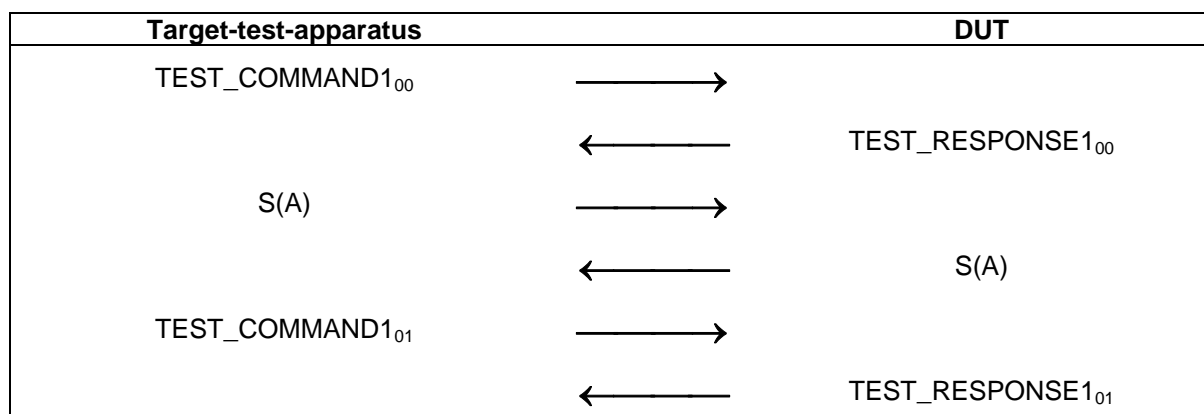

*Scenario T 10 — DEP\_REQ supervisory PDU, timeout bit not set to ZERO, erroneous transaction*

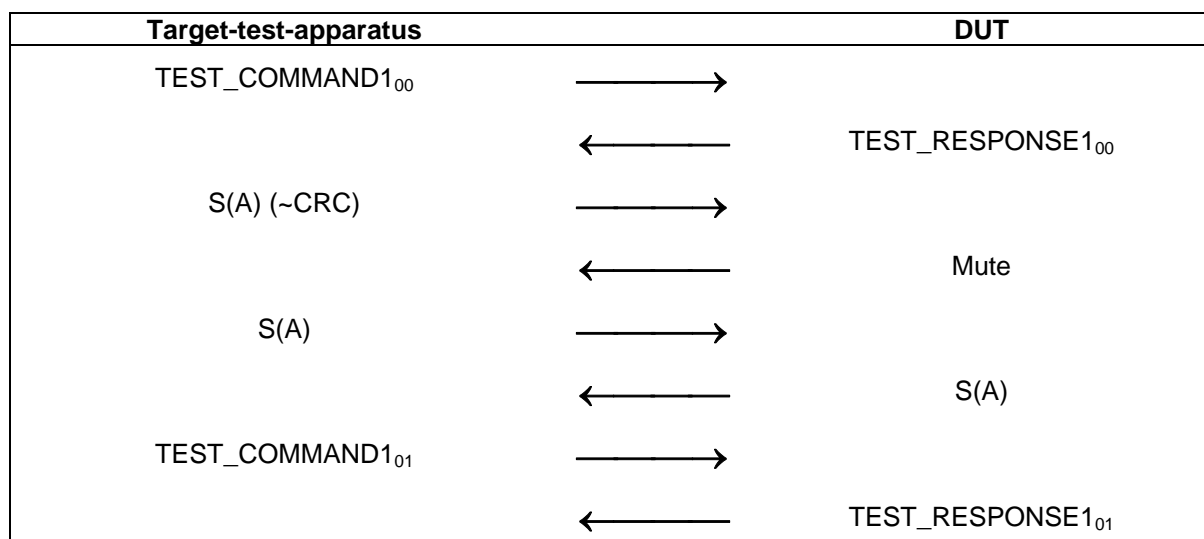

### 8.5.6.2 Test report

The test report shall indicate whether the DUT behaves correctly for all data rates and communication modes.

### 8.5.7 Handling of DSL\_REQ

The purpose of this test is to determine the correct handling of the DSL\_REQ (see ECMA-340 clause 12.7.1.3).

#### 8.5.7.1 Procedure

Repeat steps a) to f) for the data rates of 106, 212 and 424 kbps and for both Active and Passive communication Modes.

- a) Place the DUT into the operating volume.
- b) Turn on a field between the limits  $H_{\min}$  and  $H_{\max}$  and verify that the field strength does not influence the test results.
- c) Perform activation in the selected communication mode and data rate.
- d) Send an ATR\_REQ and receive the ATR\_RES from the DUT.
- e) Execute scenario T 11 followed scenario T 12.



- f) Check if the response and the PNIs from the DUT are according to the scenarios.

*Scenario T 11 — DSL\_REQ, correct transaction*

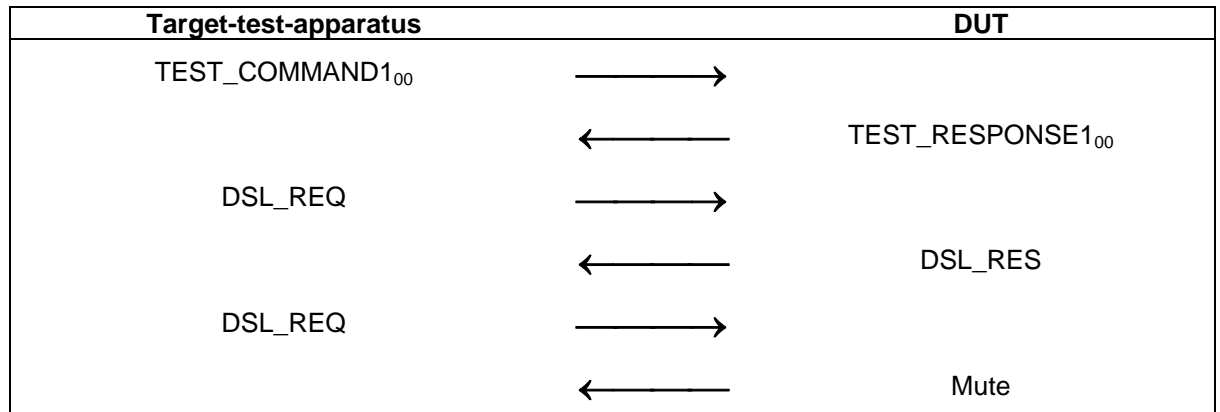

*Scenario T 12 — DSL\_REQ, erroneous transaction*

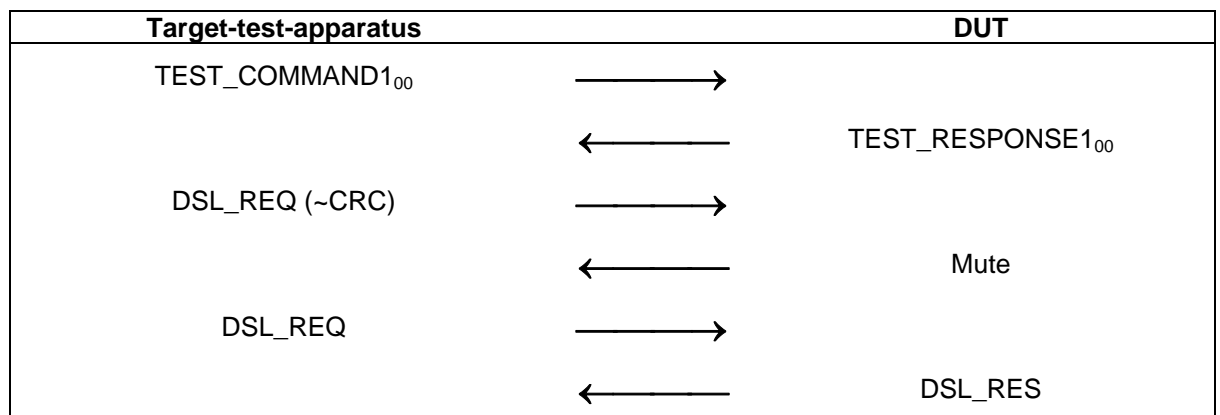

### 8.5.7.2 Test report

The test report shall indicate whether the DUT behaves correctly for all data rates and communication modes.

### 8.5.8 Handling of RLS\_REQ

The purpose of this test is to determine the correct handling of the RLS\_REQ of the DUT (see ECMA-340 clause 12.7.2.3).

#### 8.5.8.1 Procedure

Repeat steps a) to h) for the data rates of 106, 212 and 424 kbps and for both Active and Passive communication Modes.

- a) Place the DUT into the operating volume.
- b) Turn on a field between the limits  $H_{min}$  and  $H_{max}$  and verify that the field strength does not influence the test results.
- c) Perform activation in the selected communication mode and data rate.
- d) Send an ATR\_REQ and receive the ATR\_RES from the DUT.
- e) Execute scenario T 13 followed scenario T 14.
- f) Check if the response and the PNIs from the DUT are according to the scenarios.
- g) Perform activation for the selected communication mode and data rate.

h) Send ATR\_REQ and check valid ATR\_RES from the DUT.

*Scenario T 13 — RLS\_REQ, correct transaction*

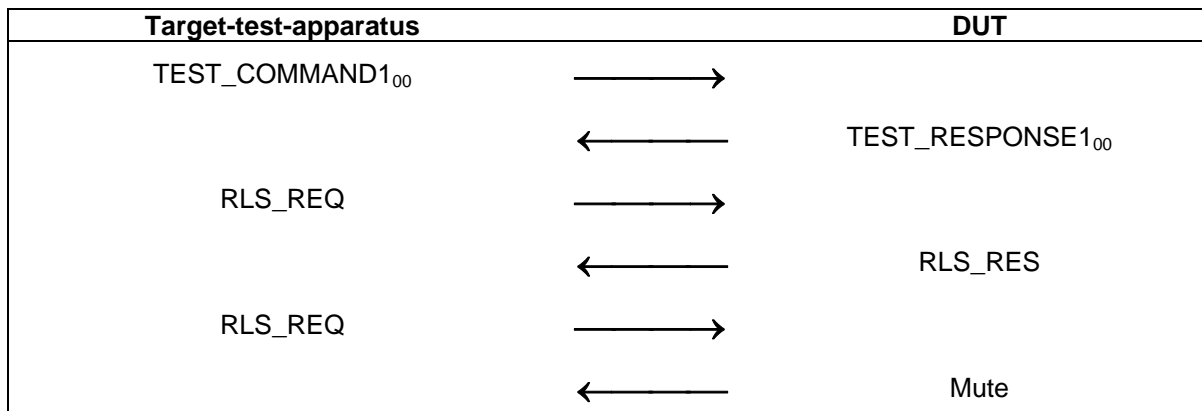

*Scenario T 14 — RLS\_REQ, erroneous transaction*

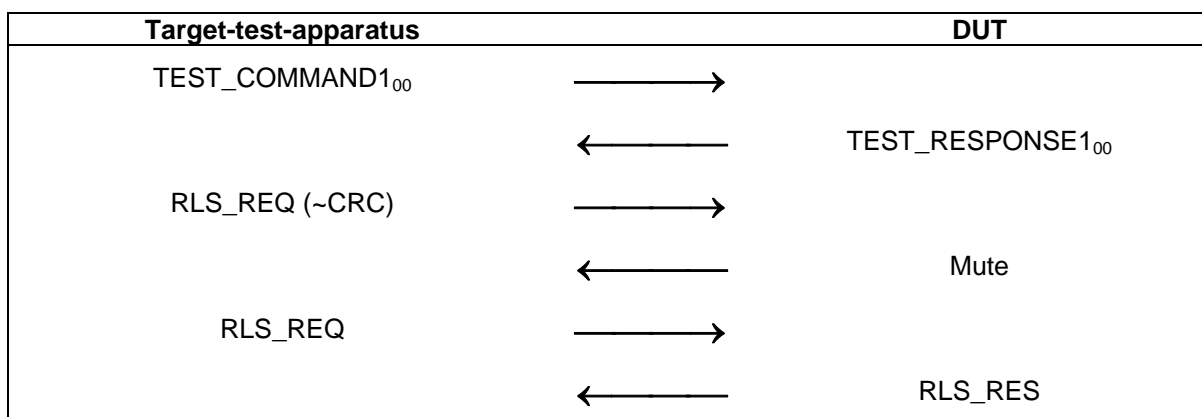

### 8.5.8.2 Test report

The test report shall indicate whether the DUT behaves correctly for all data rates and communication modes.

### 8.5.9 Handling of WUP\_REQ (Active communication Mode Only)

The purpose of this test is to determine the correct handling of the WUP\_REQ of the DUT (see ECMA-340 clause 12.5.2.3).

#### 8.5.9.1 Procedure

Repeat steps a) to g) for the data rates of 106, 212 and 424 kbps.

- Place the DUT into the operating volume.
- Turn on a field between the limits  $H_{min}$  and  $H_{max}$  and verify that the field strength does not influence the test results.
- Perform activation in Active communication Mode at the selected data rate.
- Send an ATR\_REQ and receive the ATR\_RES from the DUT.
- Execute scenario T 15 followed by scenario T 16.
- Check if the response and the PNIs from the DUT are according to the scenarios.
- Send an ATR\_REQ and receive the ATR\_RES from the DUT.

Scenario T 15 — WUP\_REQ, correct transaction

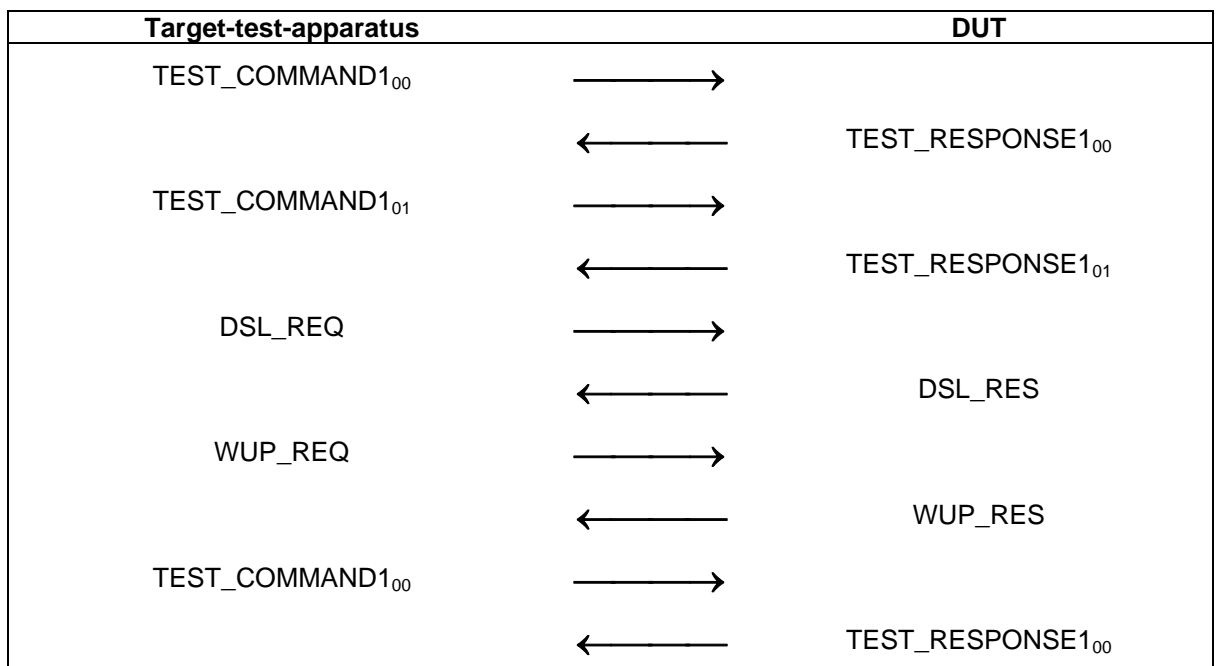

Scenario T 16 — WUP\_REQ, erroneous transaction

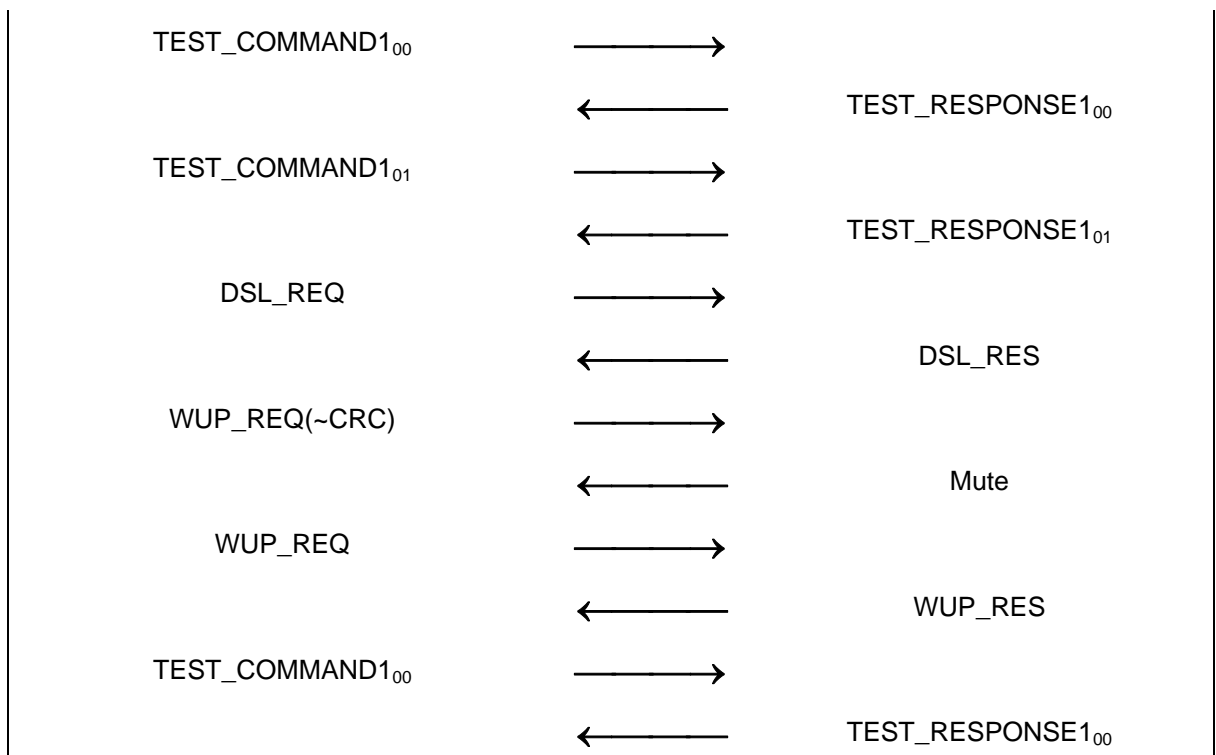
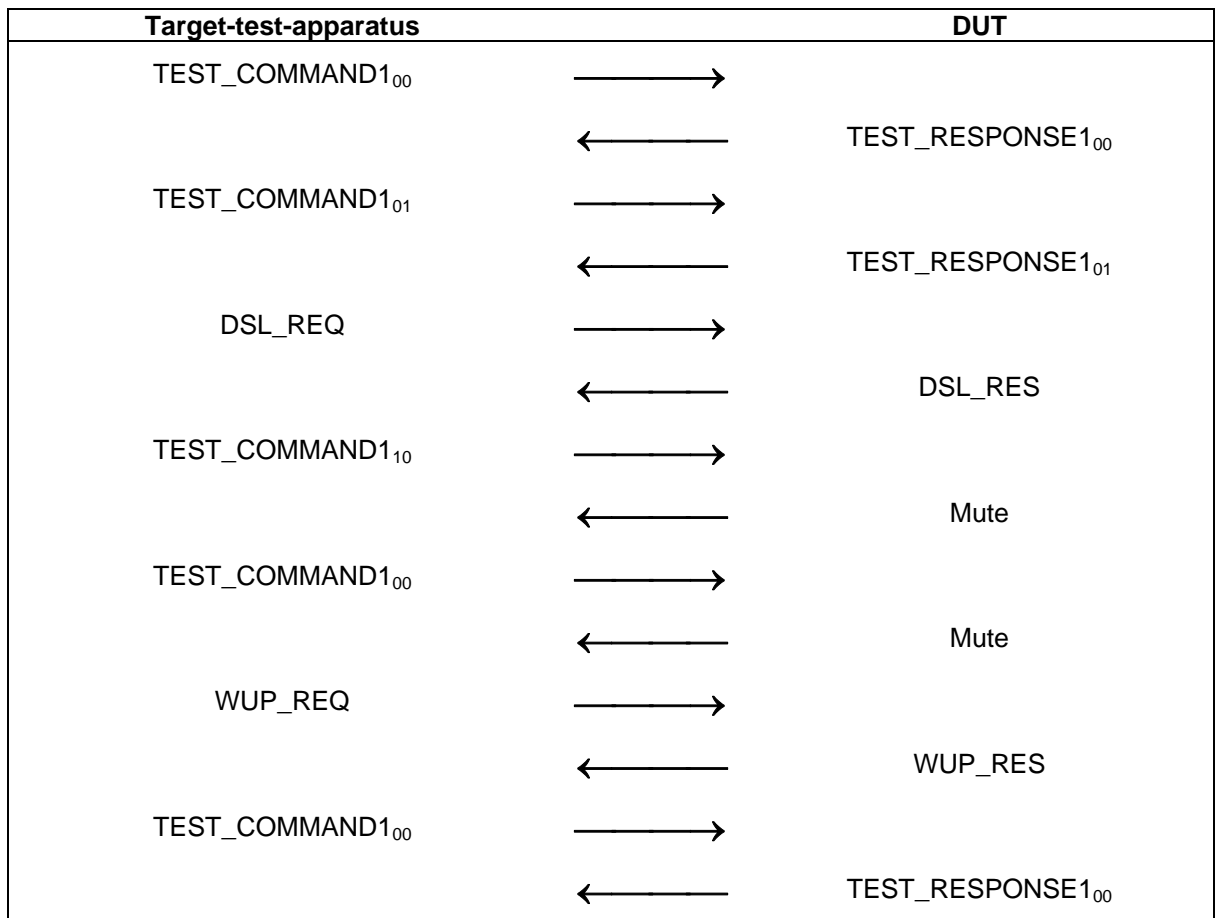

### 8.5.9.2 Test report

The test report shall indicate whether the DUT behaves correctly for all data rates.

## 9 Initiator test methods

### 9.1 Apparatus for testing the Initiator (Initiator-test-apparatus)

#### 9.1.1 Initiator test apparatus concept

The Initiator-test-apparatus consists of two parts.

- The Upper Tester (UT) configures the Initiator and instructs the Initiator to send commands. This Standard does not specify how the UT controls the DUT.
- The Lower Tester (LT) emulates the Target protocol, and includes a digital sampling oscilloscope for timing measurements.

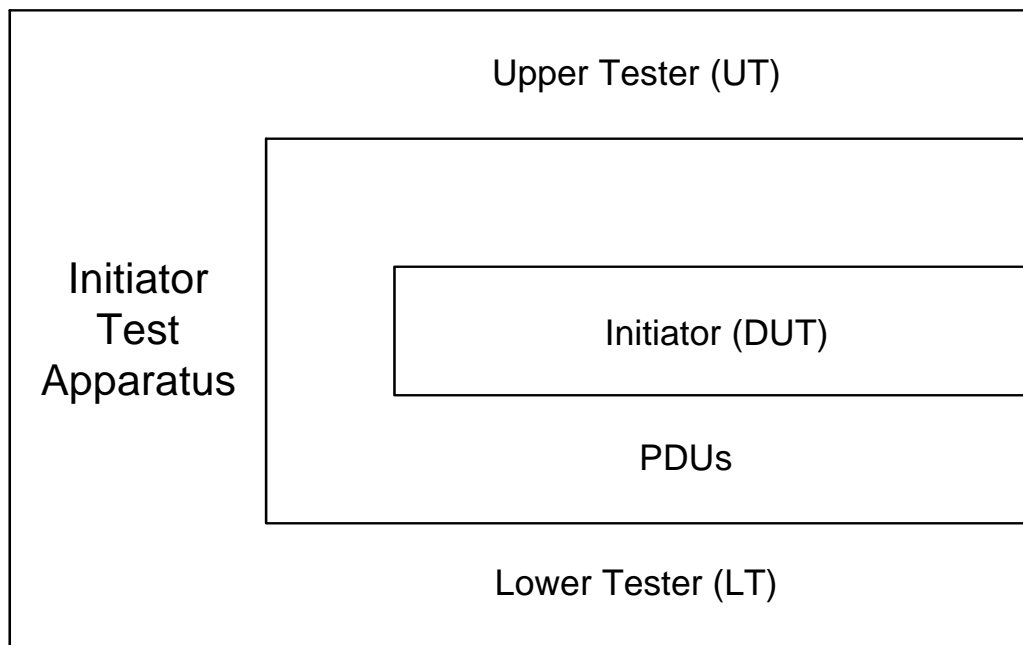

*Figure 1 — Initiator test apparatus concept*

#### 9.1.2 Protocol activation procedure for Passive communication Mode at 106 kbps

Activate the LT by executing the following sequence:

- Set the LT in Passive communication Mode at 106 kbps
- Set the DUT in Passive communication Mode at 106 kbps.
- Instruct the DUT to perform activation and SDD at 106 kbps.

#### 9.1.3 Protocol activation procedures for Passive communication Mode at 212 and 424 kbps

Repeat the following sequence for the data rates of 212 and 424 kbps:

- Set the LT in Passive communication Mode at the selected data rate.
- Set the DUT in Passive communication Mode at the selected data rate.
- Instruct the DUT to perform SDD at the selected data rate.

### 9.1.4 Protocol activation procedures for Active communication Mode

Repeat the following sequence for the data rates of 106, 212 and 424 kbps:

- a) Set the LT in Active communication Mode at the selected data rate.
- b) Set the DUT in Active communication Mode at the selected data rate.
- c) Instruct the DUT to perform Active communication Mode activation flow at selected data rate (see ECMA-340, 12.3).

## 9.2 List of protocol test methods for Initiators

This subclause lists all required protocol test methods for Initiators.

To test Initiators performing initialisation and SDD in Passive communication Mode at 106 kbps execute the PCD test methods as defined in ISO/IEC 10373-6.

To test initiators performing initialisation and SDD in Passive communication Mode at 212 and 424 kbps execute the test methods in table 4.

Table 4 — Activation in Passive communication Mode at 212 and 424kbps

Clause	Test method Name	Corresponding requirement	
		Base standard	Clause(s)
9.3.1	Frame format	ECMA-340	11.2.2.2
9.3.2	SDD at 212 and 424 kbps	ECMA-340	11.2.2.3 11.2.2.4

To test Initiators performing initialisation in Active communication Mode execute the test methods in table 5.

Table 5 — Activation in Active communication Mode

Clause	Test method Name	Corresponding requirement	
		Base standard	Clause(s)
9.4.1	Initial RF Collision Avoidance	ECMA-340	11.1.1
9.4.2	Response RF Collision Avoidance with time jitter n=0	ECMA-340	11.1.2

To test initiators using the transport protocol execute the test methods in table 6.

Table 6 — Logical operation of the Initiator Transport Protocol

Clause	Test method Name	Corresponding requirement	
		Base standard	Clause(s)
9.5.1	Handling of ATR_RES	ECMA-340	12.5.1.3
9.5.2	Handling of PSL_RES	ECMA-340	12.5.3.3
9.5.3	Handling of DEP_RES information PDUs	ECMA-340	12.6.1.2
9.5.4	Handling of DEP_RES Information PDU's with more information bit set to ONE	ECMA-340	12.6.1.3
9.5.5	Handling of DEP_RES supervisory PDU's with timeout bit set to ONE	ECMA-340	12.6.1.3
9.5.6	Handling of DEP_RES supervisory PDU's with timeout bit set to ZERO	ECMA-340	12.6.1.3
9.5.7	Handling of DSL_RES	ECMA-340	12.7.1.3
9.5.8	Handling of RLS_RES	ECMA-340	12.7.2.3

### 9.3 Activation in Passive communication Mode at 212 and 424kbps

#### 9.3.1 Frame format

The purpose of this test is to determine the correct frame format of the DUT at 212 and 424 kbps (see ECMA-340 clause 11.2.2.2).

##### 9.3.1.1 Procedure

Repeat steps a) to d) for the 212 and 424 kbps.

- a) Place the LT into the operating volume of the DUT.
- b) Execute [9.1.3](#) with selected data rate.
- c) The LT waits until the DUT sends a valid POL\_REQ.
- d) Verify that the frame attributes are in accordance to ECMA-340 clause 11.2.2.2.

##### 9.3.1.2 Test report

The test report shall indicate whether the DUT behaves correctly for both data rates.

#### 9.3.2 SDD at 212 and 424 kbps

The purpose of this test is to determine the correct handling of the POL\_REQ of the DUT (see ECMA-340 clause 11.2.2.3 and 11.2.2.4).

##### 9.3.2.1 Procedure

Repeat steps a) to f) for all TSN values and for 212 and 424 kbps data rates.

- a) Place the LT into the operating volume of the DUT.
- b) Execute [9.1.3](#) with selected TSN and selected data rate.
- c) The LT waits until the DUT sends a valid POL\_REQ.
- d) The LT answers with a POL\_RES in the last allowed timeslot.
- e) Instruct the DUT to send ATR\_REQ.
- f) The LT receives the ATR\_REQ.

##### 9.3.2.2 Test report

The test report shall indicate whether the DUT behaves correctly for both data rates and all TSN values.

## 9.4 Activation in Active communication Mode

### 9.4.1 Initial RF Collision Avoidance

The purpose of this test is to verify the behaviour of the DUT during initial RF Collision Avoidance (see ECMA-340 clause 11.1.1).

#### 9.4.1.1 Procedure

Repeat steps a) to h) for the 106, 212 and 424 kbps data rates.

- a) Place the LT into the operating volume of the DUT.
- b) The LT (field generating antenna) shall generate an RF-field. (Arrangement of test assembly can be found in ECMA-356).
- c) Ensure that the field strength at the DUT is at least  $H_{\text{Threshold}}$ .
- d) Execute [9.1.4](#) with selected data rate.
- e) The LT shall switch off its RF-field.
- f) The LT waits until the DUT sends a valid ATR\_REQ.
- g) Analyse the timing between the RF off of the LT and the RF on of the DUT (see ECMA-340 clause 11.1.1).
- h) Repeat steps a) to g) until all possible values for  $n$  of  $T_{\text{RFG}}$  are detected.

#### 9.4.1.2 Test report

The test report shall indicate whether the DUT behaves correctly for all data rates.

### 9.4.2 Response RF Collision Avoidance with time jitter $n=0$

The purpose of this test is to verify the behaviour of the DUT during response RF Collision Avoidance with time jitter  $n=0$  (see ECMA-340 clause 11.1.2).

#### 9.4.2.1 Procedure

Repeat steps a) to g) for the 106, 212 and 424 kbps data rates.

- a) Place the LT into the operating volume of the DUT.
- b) Execute [9.1.4](#) with selected data rate.
- c) The LT waits until the DUT sends a valid ATR\_REQ.
- d) The LT answers with a valid ATR\_RES.
- e) Instruct the DUT to send TEST\_COMMAND1.
- f) The LT receives the TEST\_COMMAND1.
- g) Verify that the time between the RF off of the LT and the RF on of the DUT complies with ECMA-340 clause 11.1.2.

#### 9.4.2.2 Test report

The test report shall indicate whether the timing is correct for all data rates.

## 9.5 Logical operation of the Transport Protocol

### 9.5.1 Handling of ATR\_RES

The purpose of this test is to determine the correct handling of the ATR\_RES of the DUT (see ECMA-340 clause 12.5.1.3).



### 9.5.1.1 Procedure

Repeat steps a) to c) for all specified data rates, communication modes and protocol activation procedure combinations.

- a) Place the LT into the operating volume of the DUT.
- b) Execute [9.1.2](#) for Passive communication Mode at 106 kbps, [9.1.3](#) for Passive communication Mode at 212 and 424 kbps and [9.1.4](#) for Active communication Mode at all data rates.
- c) Execute scenario I 1.

#### *Scenario I 1 — ATR\_RES*

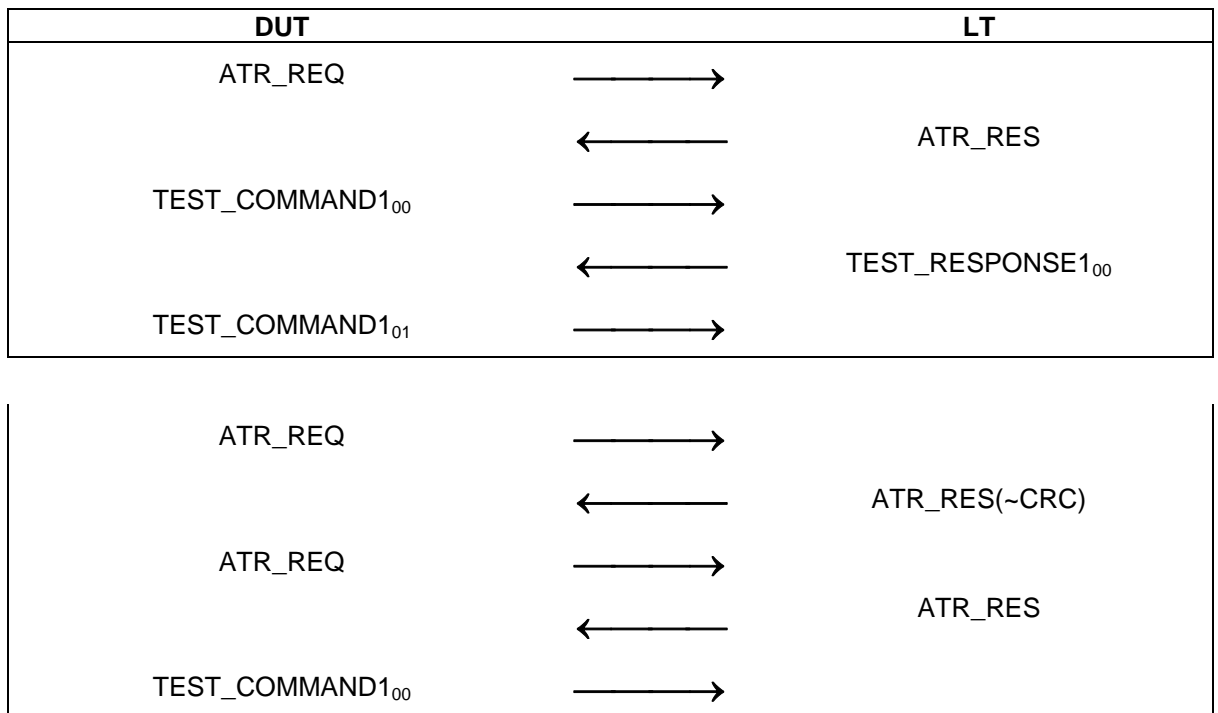

### 9.5.1.2 Test report

The test report shall indicate whether the DUT behaves correctly for all data rates and communication modes.

### 9.5.2 Handling of PSL\_RES

The purpose of this test is to determine the correct handling of the PSL\_RES (see ECMA-340 clause 12.5.3.3).

#### 9.5.2.1 Procedure

Repeat steps a) to c) for all specified data rate, communication mode and protocol activation procedure combinations.

- a) Place the LT into the operating volume of the DUT.
- b) Execute [9.1.2](#) for Passive communication Mode at 106 kbps, [9.1.3](#) for Passive communication Mode at 212 and 424 kbps and [9.1.4](#) for Active communication Mode at all data rates.
- c) Execute scenario I 2.

Scenario I 2 — PSL\_RES

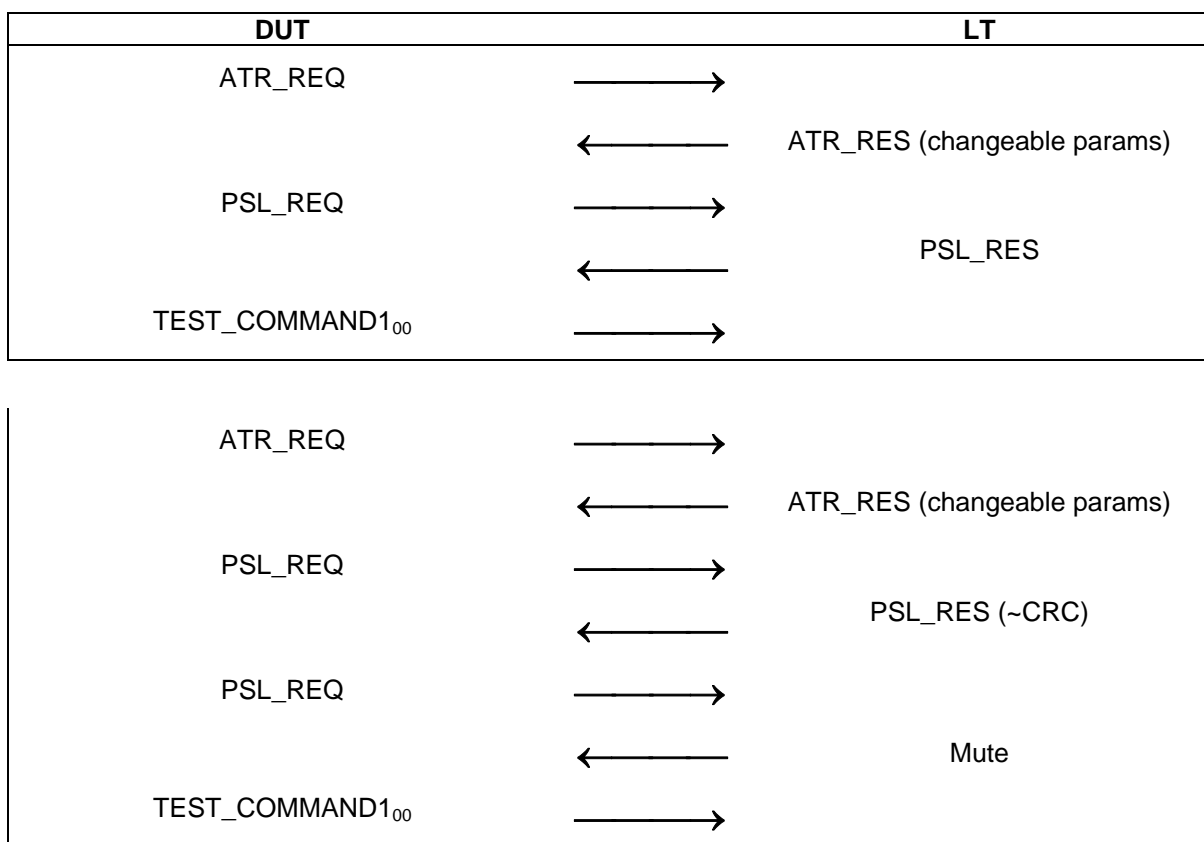

#### 9.5.2.2 Test report

The test report shall indicate whether the DUT behaves correctly for all data rates and communication modes.

#### 9.5.3 Handling of DEP\_RES Information PDUs

The purpose of this test is to determine the correct handling of the DEP\_RES (see ECMA-340 clause 12.6.1.2).

##### 9.5.3.1 Procedure

Repeat steps a) to d) for all specified data rate, communication mode and protocol activation procedure combinations.

- a) Place the LT into the operating volume of the DUT.
- b) Execute [9.1.2](#) for Passive communication Mode at 106 kbps, [9.1.3](#) for Passive communication Mode at 212 and 424 kbps and [9.1.4](#) for Active communication Mode at all data rates.
- c) Execute scenario I 3.
- d) Execute scenario I 4.

*Scenario I 3 — DEP\_RES information PDU, correct transaction*

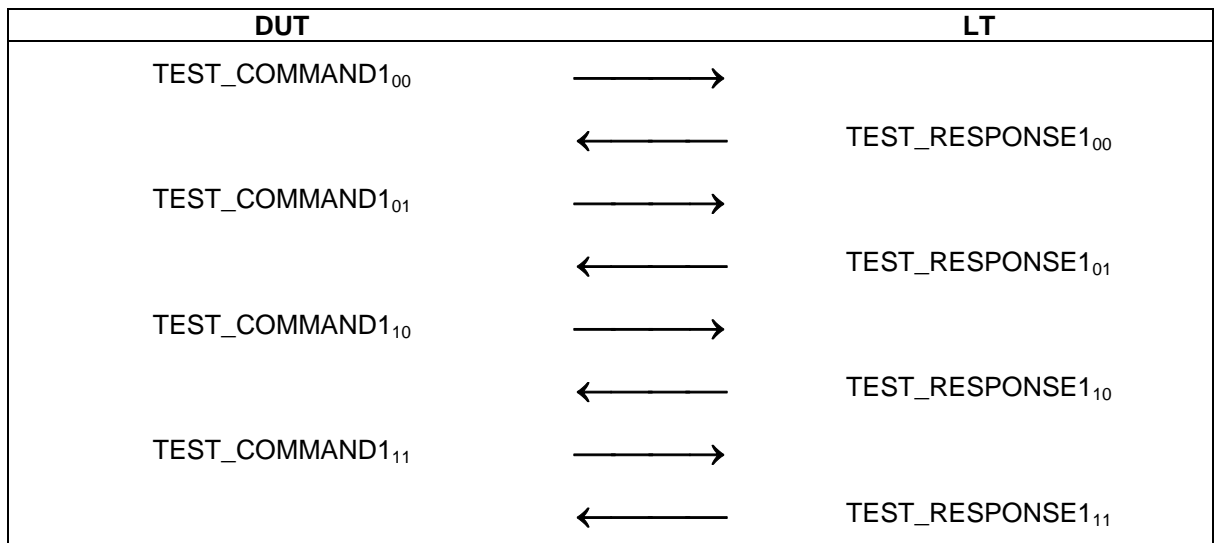

*Scenario I 4 — DEP\_RES information PDU, erroneous transaction*

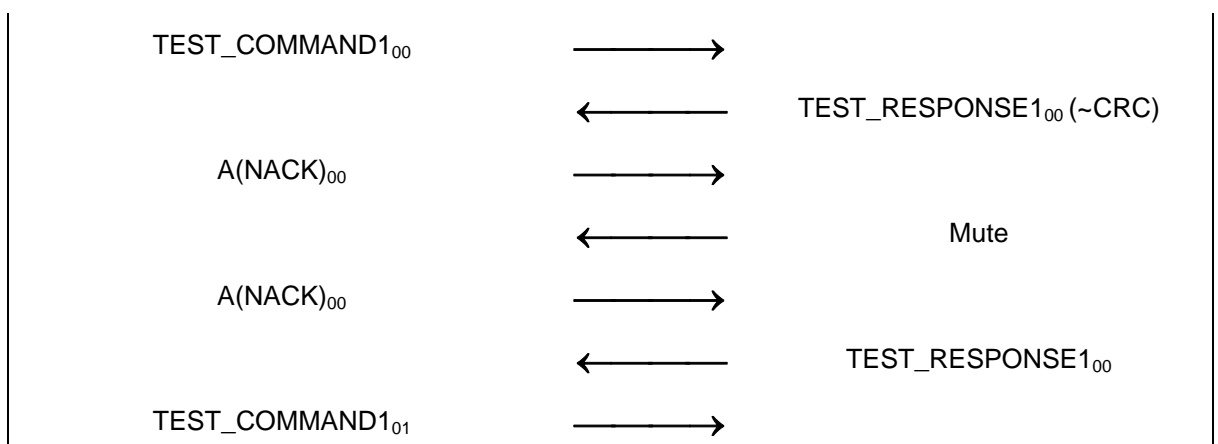
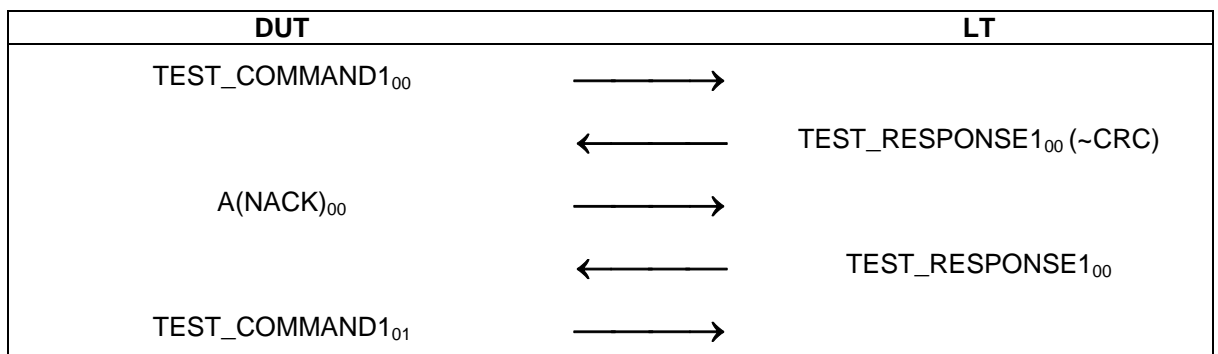

**9.5.3.2 Test report**

The test report shall indicate whether the DUT behaves correctly for all data rates and communication modes.

### 9.5.4 Handling of DEP\_RES Information PDU's with more information bit set to ONE

The purpose of this test is to determine the correct handling of the DEP\_RES with information bit set to ONE (see ECMA-340 clause 12.6.1.3).

#### 9.5.4.1 Procedure

Repeat steps a) to d) for all specified data rate, communication mode and protocol activation procedure combinations.

- a) Place the LT into the operating volume of the DUT.
- b) Execute [9.1.2](#) for Passive communication Mode at 106 kbps, [9.1.3](#) for Passive communication Mode at 212 and 424 kbps and [9.1.4](#) for Active communication Mode at all data rates.
- c) Execute scenario I 5.
- d) Execute scenario I 6.

*Scenario I 5 — DEP\_RES with more information bit set to ONE, correct transaction*

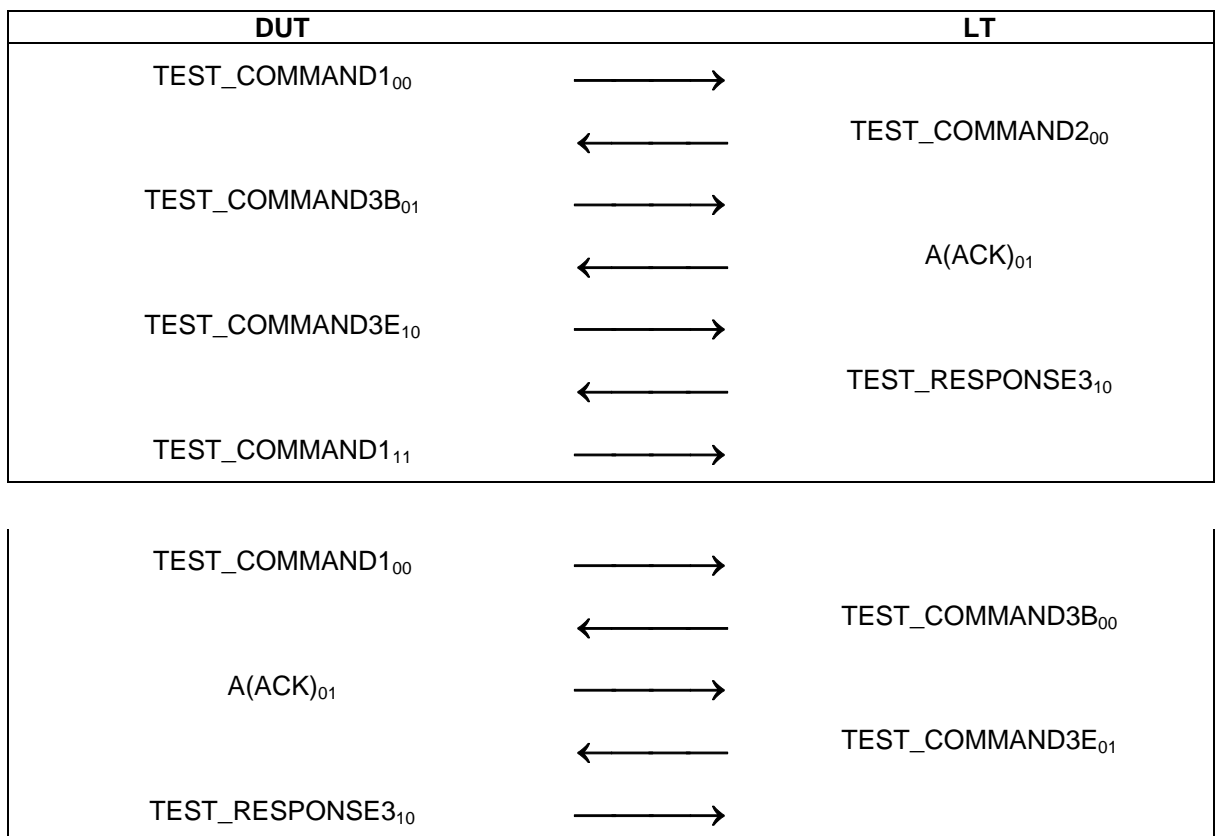

Scenario I 6 — DEP\_RES with more information bit set to ONE, erroneous transaction

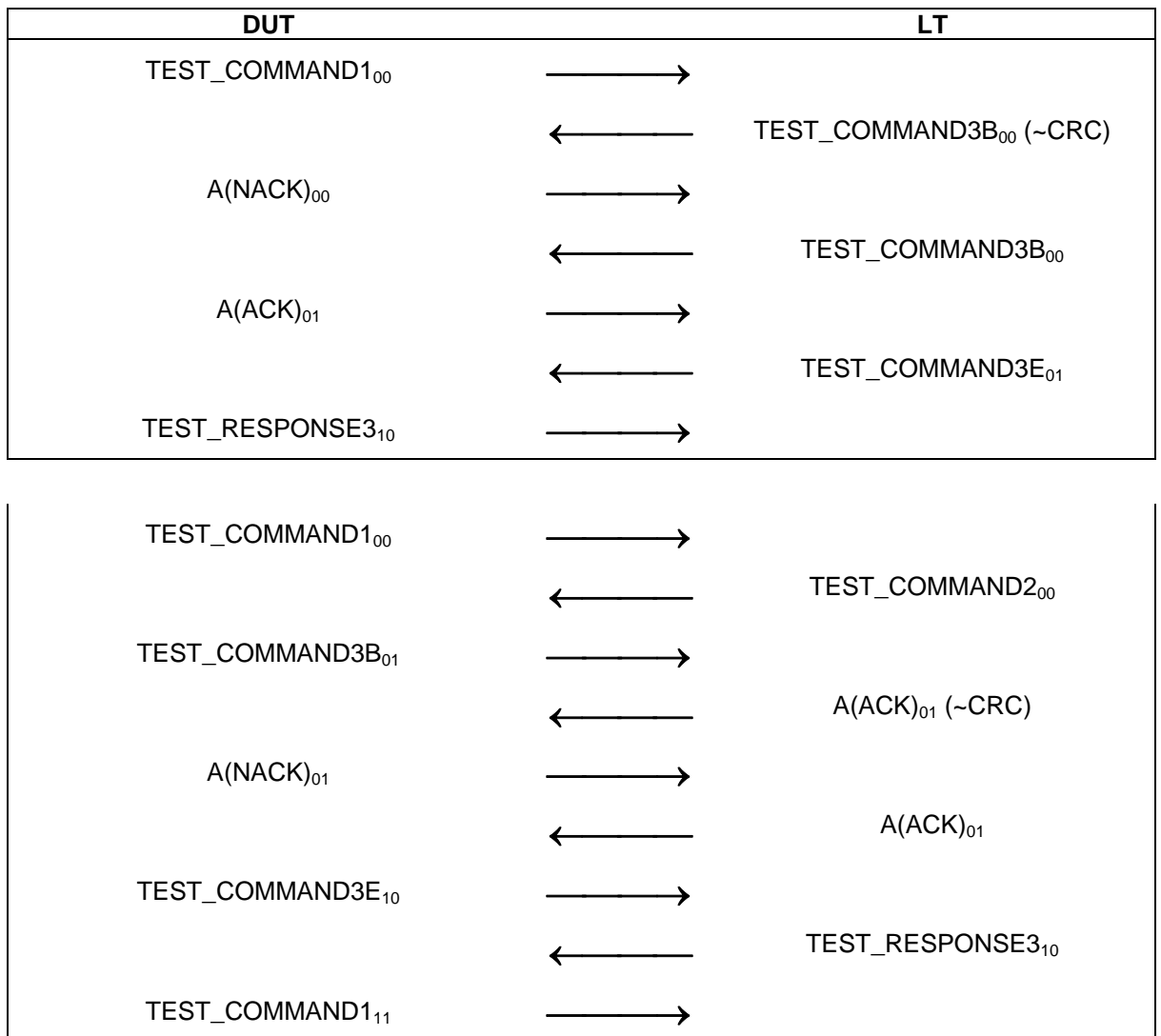

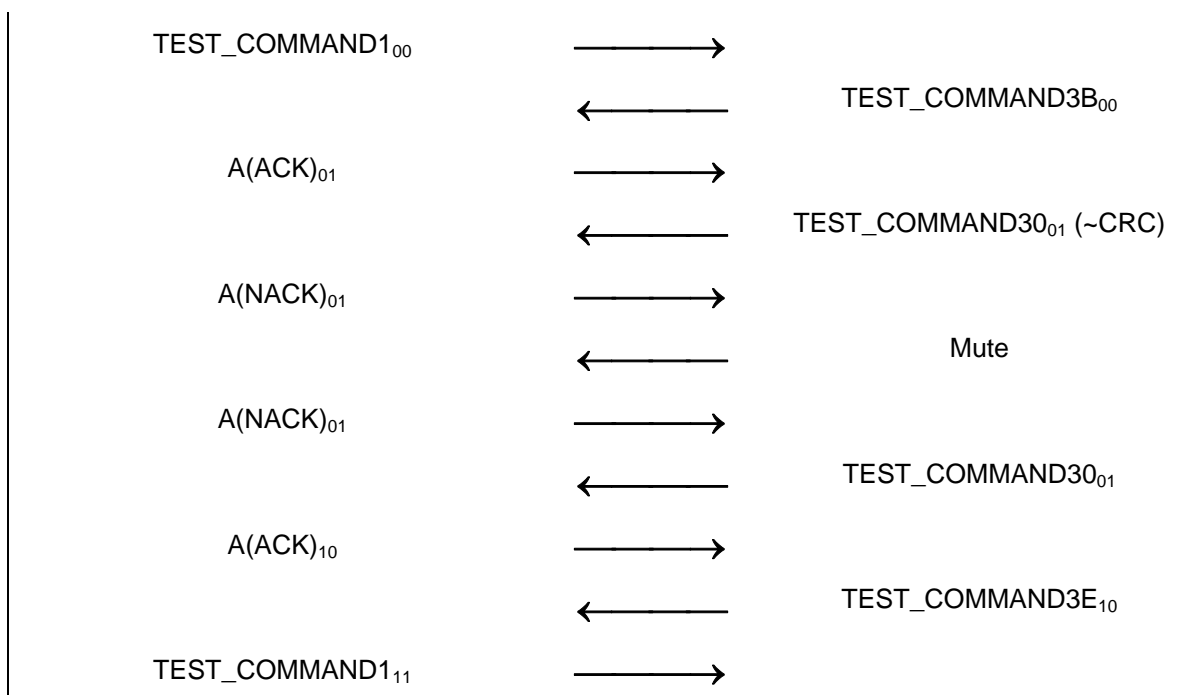

#### 9.5.4.2 Test report

The test report shall indicate whether the DUT behaves correctly for all data rates and communication modes.

#### 9.5.5 Handling of DEP\_RES supervisory PDU's with timeout bit set to ONE

The purpose of this test is to determine the correct handling of the DEP\_RES with supervisory PDUs with timeout bit set to ONE (see ECMA-340 clause 12.6.1.3).

##### 9.5.5.1 Procedure

Repeat steps a) to d) for all specified data rate, communication mode and protocol activation procedure combinations.

- a) Place the LT into the operating volume of the DUT.
- b) Execute [9.1.2](#) for Passive communication Mode at 106 kbps, [9.1.3](#) for Passive communication Mode at 212 and 424 kbps and [9.1.4](#) for Active communication Mode at all data rates.
- c) Execute scenario I 7.
- d) Execute scenario I 8.

*Scenario I 7 — DEP\_RES with timeout bit set to ONE, correct transaction*

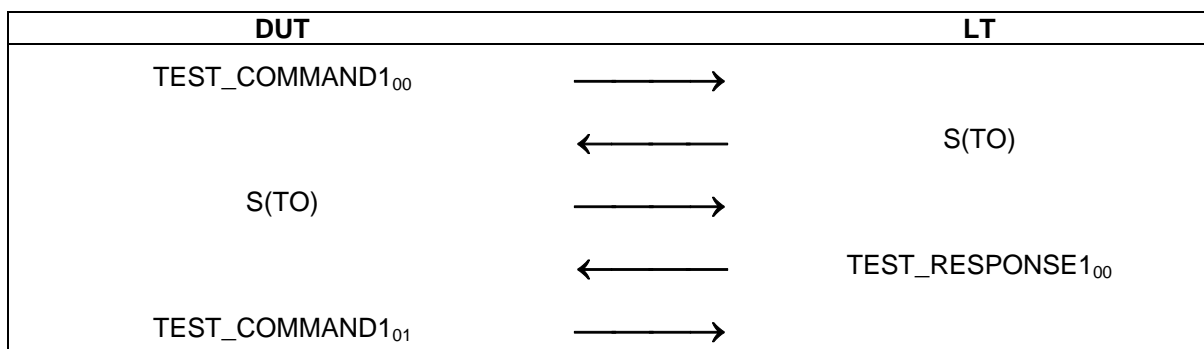

Scenario I 8 — DEP\_RES with timeout bit set to ONE, erroneous transaction

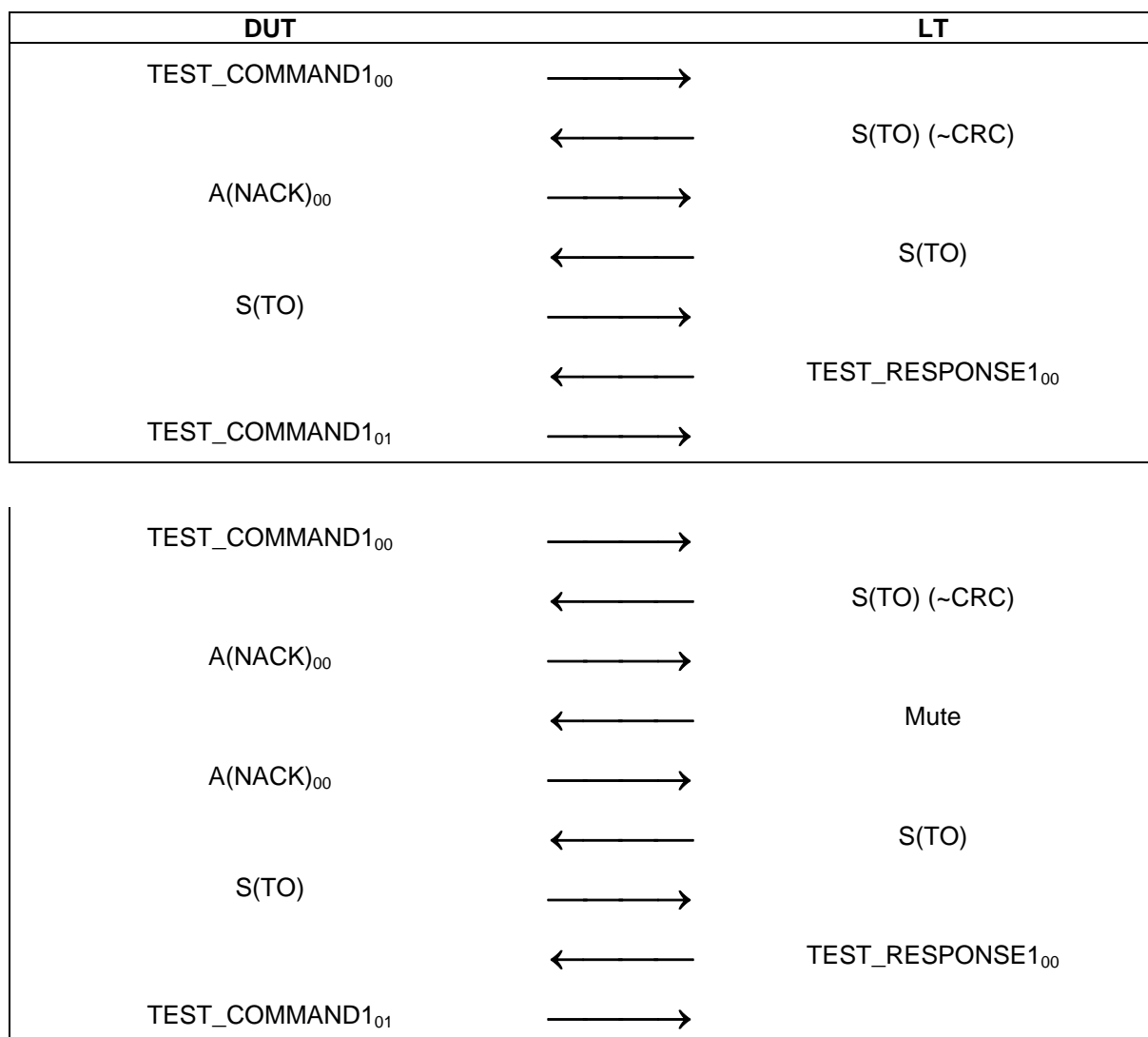

#### 9.5.5.2 Test report

The test report shall indicate whether the DUT behaves correctly for all data rates and communication modes.

#### 9.5.6 Handling of DEP\_RES supervisory PDUs with timeout bit set to ZERO

The purpose of this test is to determine the correct handling of the DEP\_RES supervisory PDU with timeout bit set to ZERO (Attention) (see ECMA-340 clause 12.6.1.3).

##### 9.5.6.1 Procedure

Repeat steps a) to d) for all specified data rate, communication mode and protocol activation procedure combinations.

- Place the LT into the operating volume of the DUT.
- Execute [9.1.2](#) for Passive communication Mode at 106 kbps, [9.1.3](#) for Passive communication Mode at 212 and 424 kbps and [9.1.4](#) for Active communication Mode at all data rates.
- Execute scenario I 9.
- Execute scenario I 10.

*Scenario I 9 — DEP\_RES with timeout bit set to ZERO, correct transaction*

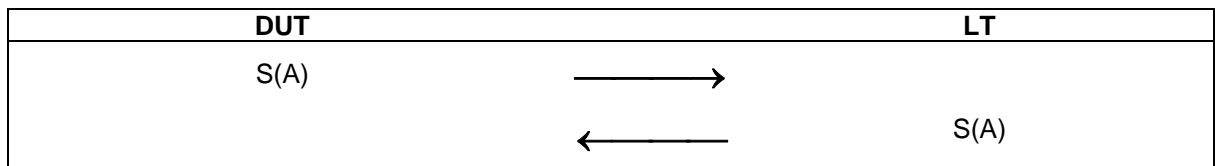

*Scenario I 10 — DEP\_RES with timeout bit set to ZERO, erroneous transaction*

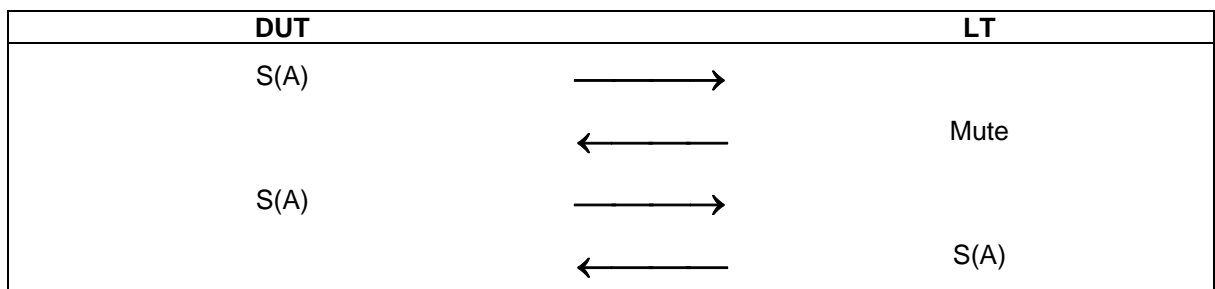

**9.5.6.2 Test report**

The test report shall indicate whether the DUT behaves correctly for all data rates and communication modes.

**9.5.7 Handling of DSL\_RES**

The purpose of this test is to determine the correct handling of the DSL\_RES of the DUT (see ECMA-340 clause 12.7.1.3).

**9.5.7.1 Procedure**

Repeat steps a) to d) for all specified data rate, communication mode and protocol activation procedure combinations.

- a) Place the LT into the operating volume of the DUT.
- b) Execute [9.1.2](#) for Passive communication Mode at 106 kbps, [9.1.3](#) for Passive communication Mode at 212 and 424 kbps and [9.1.4](#) for Active communication Mode at all data rates.
- c) Execute scenario I 11.
- d) Execute scenario I 12.

*Scenario I 11 — DSL\_RES, correct transaction*

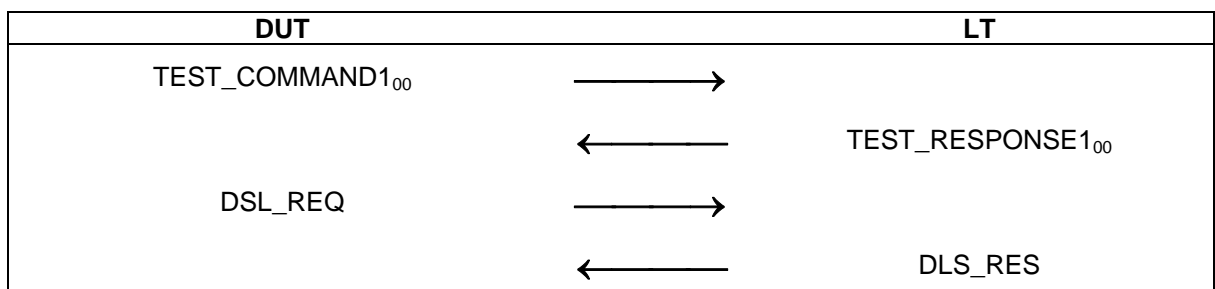



*Scenario I 12 — DSL\_RES, erroneous transaction*

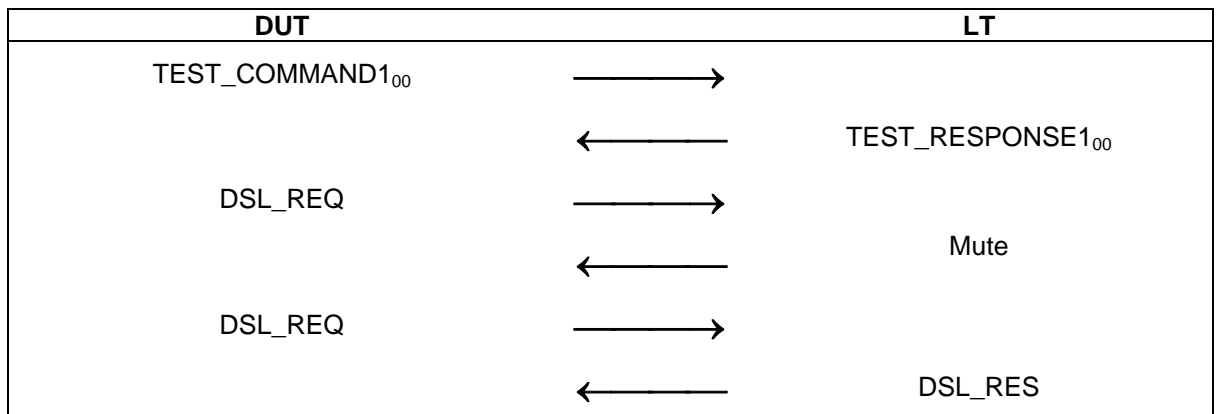

**9.5.7.2 Test report**

The test report shall indicate whether the DUT behaves correctly for all data rates and communication modes.

**9.5.8 Handling of RLS\_RES**

The purpose of this test is to determine the correct handling of the RLS\_RES of the DUT (see ECMA-340 clause 12.7.2.3).

**9.5.8.1 Procedure**

Repeat steps a) to d) for all specified data rate, communication mode and protocol activation procedure combinations.

- a) Place the LT into the operating volume of the DUT.
- b) Execute [9.1.2](#) for Passive communication Mode at 106 kbps, [9.1.3](#) for Passive communication Mode at 212 and 424 kbps and [9.1.4](#) for Active communication Mode at all data rates.
- c) Execute scenario I 13.
- d) Execute scenario I 14.

*Scenario I 13 — RLS\_RES, correct transaction*

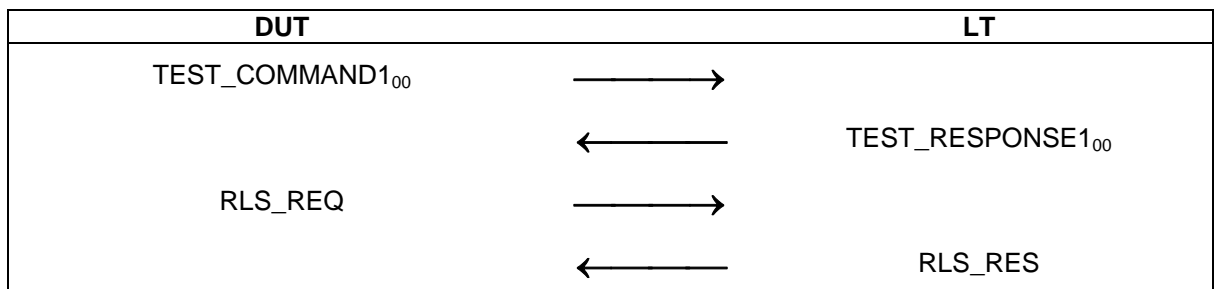

*Scenario I 14 — RLS\_RES, erroneous transaction*

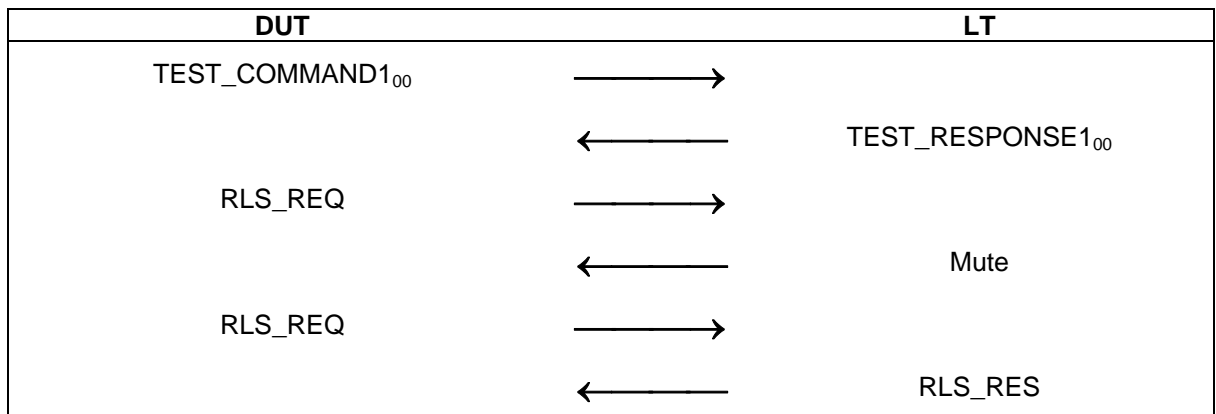

**9.5.8.2 Test report**

The test report shall indicate whether the DUT behaves correctly for all data rates and communication modes.

## Annex A (normative)

### Test report template for Target tests

Supplier:

Product:

Legend:

A: 106 kbps	Active communication Mode at 106 kbps
A: 212 kbps	Active communication Mode at 212 kbps
A: 424 kbps	Active communication Mode at 424 kbps
P: 106 kbps	Passive communication Mode at 106 kbps
P: 212 kbps	Passive communication Mode at 212 kbps
P: 424 kbps	Passive communication Mode at 424 kbps

Command and ID definitions valid for all protocol tests.			
No	Command name	Description	Data Used
1	TEST_COMMAND1	Default command used for test	
2	TEST_RESPONSE1	Default response used for TEST_COMMAND1	
3	TEST_COMMAND2	Default command used to force chaining	
4	TEST_COMMAND3	Default command using chaining. This command is divided in more than 1 part.	
5	TEST_RESPONSE3	Default response used for TEST_COMMAND3	
6	TEST_COMMAND4	Default command which forces Response Waiting Time at Target side	
7	TEST_RESPONSE4	Default response to TEST_COMMAND4 after Response Waiting Time has been processed.	
8	DID	Identifier used for tests	
9	NAD	Tested only if Target supports NAD	Yes / No
10	Chaining	Tested only if Target supports commands longer than 63 bytes	Yes / No

8.3 Activation in Passive communication Mode at 212 and 424 kbps.						
No	Testname	Expected result according to ECMA-340	Reference chapter in ECMA-340	Condition	Test results PASS/FAIL	
1	<a href="#">8.3.1 Activation time</a>	The test passes if the DUT responds in the time defined in ECMA-340.	11.2.2.3	P: 212 kbps		
				P: 424 kbps		
2	<a href="#">8.3.2 Frame format</a>	The test passes if the Preamble, SYNC, Length and CRC are according to ECMA-340.	11.2.2.2	P: 212 kbps		
				P: 424 kbps		
3	<a href="#">8.3.3 SDD at 212 and 424 kbps</a>	The test passes if the data and the response time are according to ECMA-340.	11.2.2.4	P: 212 kbps		
				P: 424 kbps		
8.4 Activation in Active communication Mode						
No	Testname	Expected result according to ECMA-340	Reference chapter in ECMA-340	Condition	Test results PASS/FAIL	
1	<a href="#">8.4.1 RF Collision Avoidance</a>	The test passes if the DUT activates its RF field as specified in ECMA-340.	11.1.2	A: 106 kbps		
				A: 212 kbps		
				A: 424 kbps		
8.5 Logical operation of the Target Transport Protocol.						
No	Test name	Expected result	Reference chapter in ECMA-340	Scenario number	Condition	Test results PASS/FAIL
1	<a href="#">8.5.1 Handling of ATR_REQ</a>	The test passes if DUT behaves as described in the scenario.	12.5.1.3.2	T 1	P: 106 kbps	
					P: 212 kbps	
					P: 424 kbps	
					A: 106 kbps	
					A: 212 kbps	

					A: 424 kbps	
2	<a href="#">8.5.2 Handling of PSL_REQ</a>	The test passes if DUT behaves as described in the scenario.	12.5.3.3.2	T 2	P: 106 kbps	
					P: 212 kbps	
					P: 424 kbps	
					A: 106 kbps	
					A: 212 kbps	
					A: 424 kbps	
3	<a href="#">8.5.3 Handling of DEP_REQ Information PDUs</a>	The test passes if DUT behaves as described in the scenarios.	12.6.1.3	T 3 T 4	P: 106 kbps	
					P: 212 kbps	
					P: 424 kbps	
					A: 106 kbps	
					A: 212 kbps	
					A: 424 kbps	
4	<a href="#">8.5.4 Handling of DEP_REQ Information PDUs with the "more information" bit set to ONE</a>	The test passes if DUT behaves as described in the scenarios.	12.6.1.3	T 5 T 6	P: 106 kbps	
					P: 212 kbps	
					P: 424 kbps	
					A: 106 kbps	
					A: 212 kbps	
					A: 424 kbps	
5	<a href="#">8.5.5 Handling of DEP_REQ supervisory PDU's with timeout bit set to ONE</a>	The test passes if DUT behaves as described in the scenarios.	12.6.1.3	T 7 T 8	P: 106 kbps	
					P: 212 kbps	
					P: 424 kbps	
					A: 106 kbps	
					A: 212 kbps	
					A: 424 kbps	
6	<a href="#">8.5.6 Handling of DEP_REQ supervisory PDUs with timeout bit set to ZERO</a>	The test passes if DUT behaves as described in the scenarios.	12.6.1.3	T 9 T 10	P: 106 kbps	
					P: 212 kbps	
					P: 424 kbps	
					A: 106 kbps	
					A: 212 kbps	
					A: 424 kbps	
7	<a href="#">8.5.7 Handling of DSL_REQ</a>	The test passes if DUT behaves as described in the scenarios.	12.7.1.3	T 11 T 12	P: 106 kbps	
					P: 212 kbps	
					P: 424 kbps	
					A: 106 kbps	
					A: 212 kbps	
					A: 424 kbps	

8	<a href="#">8.5.8 Handling of RLS_REQ</a>	The test passes if DUT behaves as described in the scenarios.	12.7.2.3	T 13 T 14	P: 106 kbps	
					P: 212 kbps	
					P: 424 kbps	
					A: 106 kbps	
					A: 212 kbps	
					A: 424 kbps	
9	<a href="#">8.5.9 Handling of WUP_REQ (Active communication Mode Only)</a>	The test passes if DUT behaves as described in the scenarios.	12.7.2.3	T 15 T 16	A: 106 kbps	
					A: 212 kbps	
					A: 424 kbps	

## Annex B (normative)

### Test report template for Initiator tests

Supplier:

Product:

Legend:

A: 106 kbps	Active communication Mode at 106 kbps
A: 212 kbps	Active communication Mode at 212 kbps
A: 424 kbps	Active communication Mode at 424 kbps
P: 106 kbps	Passive communication Mode at 106 kbps
P: 212 kbps	Passive communication Mode at 212 kbps
P: 424 kbps	Passive communication Mode at 424 kbps

Commands and ID definitions used for protocol tests.			
No	Command name	Description	Data Used
1	TEST_COMMAND1	Default command used for test	
2	TEST_RESPONSE1	Default response used for TEST_COMMAND1	
3	TEST_COMMAND2	Default command used to force chaining	
4	TEST_COMMAND3	Default command using chaining. This command is divided in more than 1 part.	
5	TEST_RESPONSE3	Default response used for TEST_COMMAND3	
6	TEST_COMMAND4	Default command which forces Response Waiting Time at Target side	
7	TEST_RESPONSE4	Default response to TEST_COMMAND4 after Response Waiting Time has been processed.	
8	DID	Identifier used for tests	
9	NAD	Tested only if the Initiator uses NAD	Yes / No
10	Chaining	Tested only if the Initiator supports commands longer than 63 bytes	Yes / No

9.3 Activation in Passive communication Mode at 212 and 424kbps						
No	Testname	Expected result according to ECMA-340	Reference chapter in ECMA-340	Condition	Test results PASS/FAIL	
1	<a href="#">9.3.1 Frame format</a>	If the Preamble, SYNC, Length and CRC are according to ECMA-340 the test is passed.	11.2.2.2	P: 212 kbps		
				P: 424 kbps		
2	<a href="#">9.3.2 SDD at 212 and 424 kbps</a>	The test passes if the data and the response time are according to ECMA-340.	11.2.2.3 11.2.2.4	P: 212 kbps		
				P: 424 kbps		
9.4 Activation in Active communication Mode						
No	Testname	Expected result according to ECMA-340	Reference chapter in ECMA-340	Condition	Test results PASS/FAIL	
1	<a href="#">9.4.1 Initial RF Collision Avoidance</a>	The test passes if the DUT activates its RF field as specified in ECMA-340.	11.1.2	A: 106 kbps		
				A: 212 kbps		
				A: 424 kbps		
9.5 Logical operation of the Transport Protocol						
No	Test name	Expected result	Reference chapter in ECMA-340	Scenario number	Condition	Test results PASS/FAIL
1	<a href="#">9.5.1 Handling of ATR_RES</a>	The test passes if DUT behaves as described in the scenario.	12.5.1.3	1 1	P: 106 kbps	
					P: 212 kbps	
					P: 424 kbps	
					A: 106 kbps	
					A: 212 kbps	
					A: 424 kbps	



2	<a href="#">9.5.2 Handling of PSL_RES</a>	The test passes if DUT behaves as described in the scenario.	12.5.3.3	I 2	P: 106 kbps	
					P: 212 kbps	
					P: 424 kbps	
					A: 106 kbps	
					A: 212 kbps	
A: 424 kbps						
3	<a href="#">9.5.3 Handling of DEP_RES Information PDUs</a>	The test passes if DUT behaves as described in the scenarios.	12.6.1.2	I 3 I 4	P: 106 kbps	
					P: 212 kbps	
					P: 424 kbps	
					A: 106 kbps	
					A: 212 kbps	
A: 424 kbps						
4	<a href="#">9.5.4 Handling of DEP_RES Information PDU's with more information bit set to ONE</a>	The test passes if DUT behaves as described in the scenarios.	12.6.1.3	I 5 I 6	P: 106 kbps	
					P: 212 kbps	
					P: 424 kbps	
					A: 106 kbps	
					A: 212 kbps	
A: 424 kbps						
5	<a href="#">9.5.5 Handling of DEP_RES supervisory PDU's with timeout bit set to ONE</a>	The test passes if DUT behaves as described in the scenarios.	12.6.1.3	I 7 I 8	P: 106 kbps	
					P: 212 kbps	
					P: 424 kbps	
					A: 106 kbps	
					A: 212 kbps	
A: 424 kbps						
6	<a href="#">9.5.6 Handling of DEP_RES supervisory PDUs with timeout bit set to ZERO</a>	The test passes if DUT behaves as described in the scenarios.	12.6.1.3	I 9 I 10	P: 106 kbps	
					P: 212 kbps	
					P: 424 kbps	
					A: 106 kbps	
					A: 212 kbps	
A: 424 kbps						
7	<a href="#">9.5.7 Handling of DSL_RES</a>	The test passes if DUT behaves as described in the scenarios.	12.7.1.3	I 11 I 12	P: 106 kbps	
					P: 212 kbps	
					P: 424 kbps	
					A: 106 kbps	
					A: 212 kbps	
A: 424 kbps						

8	<a href="#">9.5.8 Handling of RLS RES</a>	The test passes if DUT behaves as described in the scenarios.	12.7.2.3	I 13 I 14	P: 106 kbps	
					P: 212 kbps	
					P: 424 kbps	
					A: 106 kbps	
					A: 212 kbps	
					A: 424 kbps	

