

Standard ECMA-397

1st Edition / December 2010

**Short Distance Visible
Light Communication
(SDVLC)**

Standard



is the registered trademark of Ecma International



COPYRIGHT PROTECTED DOCUMENT

Contents

Page

1	Scope	1
2	Conformance	1
3	Normative references	1
4	Terms and definitions	1
5	Conventions and notations	5
6	General	5
7	Physical Layer	6
8	Transmitter and Receiver Block Diagram	7
8.1	Transmitter to Receiver Link	7
8.2	Data Encoding	7
8.2.1	8B10 Data Encoding	7
8.2.2	2B4B Data Encoding	7
8.3	Modulation	8
8.4	Bit Order	8
9	Frame Formats	8
9.1	Frame Structure overview	8
9.2	Frame Structure Detail	10
9.2.1	Start Indicator Structure	10
9.2.2	Control Header Structure	11
9.3	MAC PDU Structure	13
9.3.1	MAC Header	13
9.3.2	Payload	14
9.3.3	Payload CRC	15
9.4	Visible Frame	15
9.4.1	Visible Pattern	15
9.5	Cyclic Redundancy Check (CRC)	16
10	Connection Procedure	16
11	Association Operation Messages	17
11.1	Association Request (AS-REQ)	17
11.2	Association Response (AS-RSP)	18
11.3	Association Acknowledge (AS-ACK)	18
11.4	Disassociation Request (DAS-REQ)	19
11.5	Disassociation Response (DAS-RSP)	19
11.6	Disassociation Acknowledge (DAS-ACK)	20
12	Data Burst Modes Operation	20
12.1	Periodic Burst Mode	20
12.1.1	Burst Request Message (BR-REQ)	21
12.1.2	Burst Response Message (BR-RSP)	22
12.2	Aperiodic Burst Mode	24
12.2.1	Aperiodic Burst Request Message (ABR-REQ)	25
12.2.2	Aperiodic Burst Response Message (ABR-RSP)	26
13	Data Encoding Change	28
13.1	ENC-REQ (Data Encoding Change Request)	29
13.2	ENC-RSP (Data Encoding Change Response)	29

Introduction

SDVLC uses visible light LEDs for data communication. In most cases, LEDs with the primary purpose of illumination will take on the secondary purpose of acting as a digital data communication source; in other cases the LED's primary purpose will be data communication while the secondary purpose will be to communicate visible status to the user. With the extension of the application of LEDs from the primary purpose of illumination to the secondary purpose of data communication, VLC (Visible Light Communication) can be also applied to short range data communication.

With SDVLC, "what you see is what you send". One possible application of SDVLC is high speed mobile to mobile communication.

This Ecma Standard has been adopted by the General Assembly of December 2010.

"DISCLAIMER

This document and possible translations of it may be copied and furnished to others, and derivative works that comment on or otherwise explain it or assist in its implementation may be prepared, copied, published, and distributed, in whole or in part, without restriction of any kind, provided that the above copyright notice and this section are included on all such copies and derivative works. However, this document itself may not be modified in any way, including by removing the copyright notice or references to Ecma International, except as needed for the purpose of developing any document or deliverable produced by Ecma International (in which case the rules applied to copyrights must be followed) or as required to translate it into languages other than English.

The limited permissions granted above are perpetual and will not be revoked by Ecma International or its successors or assigns.

This document and the information contained herein is provided on an "AS IS" basis and ECMA INTERNATIONAL DISCLAIMS ALL WARRANTIES, EXPRESS OR IMPLIED, INCLUDING BUT NOT LIMITED TO ANY WARRANTY THAT THE USE OF THE INFORMATION HEREIN WILL NOT INFRINGE ANY OWNERSHIP RIGHTS OR ANY IMPLIED WARRANTIES OF MERCHANTABILITY OR FITNESS FOR A PARTICULAR PURPOSE."

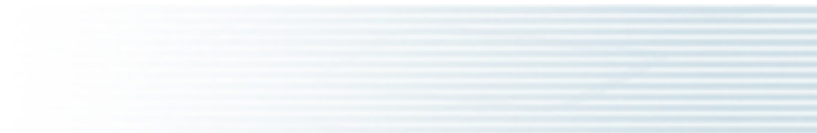

Short Distance Visible Light Communication (SDVLC)

1 Scope

This Ecma Standard specifies a PHY and MAC for communication of up to 10 cm distance with an f_m of 120 MHz using visual light with the wavelength between 380 and 780 nm.

In addition it specifies human detectable brightness control that is independent from the modulation for the data transfer.

2 Conformance

Conformant implementations:

- have both a Transmitter and a Receiver.
- use 8B10B encoding and may use 2B4B encoding.
- use an f_m of 120 MHz as specified in 8.3.

3 Normative references

The following referenced documents are indispensable for the application of this document. For dated references, only the edition cited applies. For undated references, the latest edition of the referenced document (including any amendments) applies.

ECMA-340, *Near Field Communication - Interface and Protocol (NFCIP-1)*

ISO/IEC 7498-1, *Information technology – Open Systems Interconnection – Basic Reference Model – Part 1: The Basic Model*

ISO/IEC 14165-251, *Information technology -- Fibre Channel -- Part 251: Framing and Signaling (FC-FS)*

ITU-T Z.100, *Specification and description language (SDL)*

RFC 791, *Internet Protocol - DARPA Internet Program – Protocol Specification*

4 Terms and definitions

For the purposes of this document, the following terms, definitions and abbreviations apply, in addition to those in ISO/IEC 7498-1.

4.1

Ack

Acknowledge

4.2

AK

Ack/Nack

4.3
ABR-REQ
Aperiodic Burst Request

4.4
ABR-RSP
Aperiodic Burst Response

4.5
AS-ACK
Association Acknowledge

4.6
AS-REQ
Association Request

4.7
AS-RSP
Association Response

4.8
Burst Master
Burst scheduler

4.9
Burst Slave
Burst schedule follower

4.10
BR-REQ
Burst Request

4.11
BR-RSP
Burst Response

4.12
BS
Burst Start

4.13
BWS
Burst Window Size

4.14
CHC
Control Header CRC

4.15
CRC
Cyclic Redundancy Check

4.16
DAS-ACK
Disassociation Acknowledge

4.17
DAS-REQ
Disassociation Request

4.18**DAS-RSP**

Disassociation Response

4.19**DCC-REQ**

Duty Cycle Change Request

4.20**DCC-RSP**

Duty Cycle Change Response

4.21**dectet**

group of 10 bits (cf. octet)

4.22**DER**

Data Encoding Response

4.23**Disassociatee**

recipient of a DAS-REQ

4.24**Disassociator**

initiator of a disassociation

4.25**DQWS**

Data Quiet Window Size

4.26**ENC**

Data Encoding

4.27**FL**

Frame Length

4.28 **f_m**

Frequency of modulation clock that changes the optical output signal

4.29**FT**

Frame Type

4.30**Initiator**

initiator of an association

4.31**LEN**

Length

4.32**MF**

MAC Flag

4.33
MHC
MAC Header CRC

4.34
MM
Management Message

4.35
Nack
Negative Acknowledge

4.36
OOK
On-Off Keying

4.37
OP
Operation

4.38
PL
Payload Length

4.39
PDU
Protocol Data Unit [ISO/IEC 7498-1]

4.40
PSN
PDU Sequence Number

4.41
RC
Response Code

4.42
Recipient
receiver of a frame

4.43
RFU
Reserved for Future Use

4.44
RID
Recipient ID

4.45
RVF
Recipient VF

4.46
SDL
Specification and Description Language [ITU-T Z.100]

4.47
SDU
Service Data Unit [ISO/IEC 7498-1]

4.48
SDVLC
Short Distance Visible Light Communication

4.49
Sender
sender of a frame

4.50
SI
Start Indicator

4.51
SID
Sender ID

4.52
SMF
Supported Modulation Frequencies

4.53
Target
recipient of an AS-REQ

4.54
VF
Visible Frame

4.55
VFA
VF Mode Stop Approve

4.56
VFR
VF Mode Stop Request

4.57
VLC
Visible Light Communication

5 Conventions and notations

The following conventions and notations apply in this document unless otherwise stated.

- The setting of bits is denoted by ZERO or ONE.
- An individual bit in a field is identified by a numerical subscript of the field name, where for numeric values the least significant bit of the value is assigned to the bit with subscript 0.
- (xxxxxxx)_b denotes a sequence of binary digits.

6 General

All RFU bits shall be set to 0 by the Sender and ignored by the Recipient.

Unless otherwise stated, all RFU values shall be ignored by the Recipient.

7 Physical Layer

Figure 1 illustrates the basic model of the SDVLC Transmitter and Receiver.

A SDVLC Transmitter shall have an optical output with a minimum peak irradiance of 3 W/m^2 between 380 nm and 780 nm over an area of at least $1,0 \text{ cm} \times 1,0 \text{ cm}$ at a distance of 10 cm, and a 10% to 90% rise time t_r and fall time t_f of at most 3,0 ns, illustrated in Figure 2. The SDVLC Transmitter shall have a maximum off irradiance of 1 mW/m^2 .

A SDVLC Receiver shall have an optical sensitivity from 380 nm to 780 nm and from 0 cm to at least 10 cm from a SDVLC Transmitter.

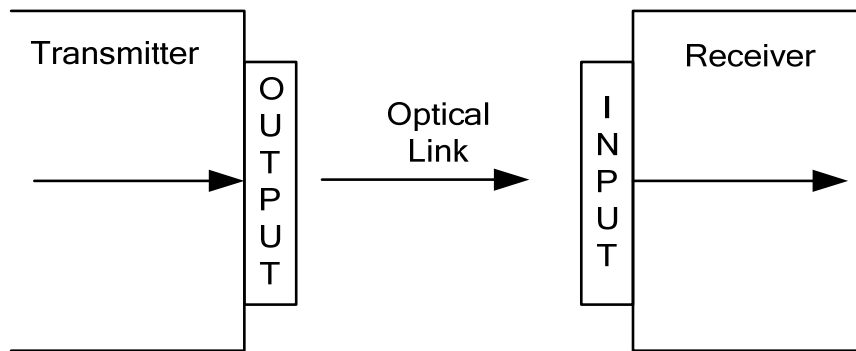

Figure 1 — SDVLC Transmitter and Receiver

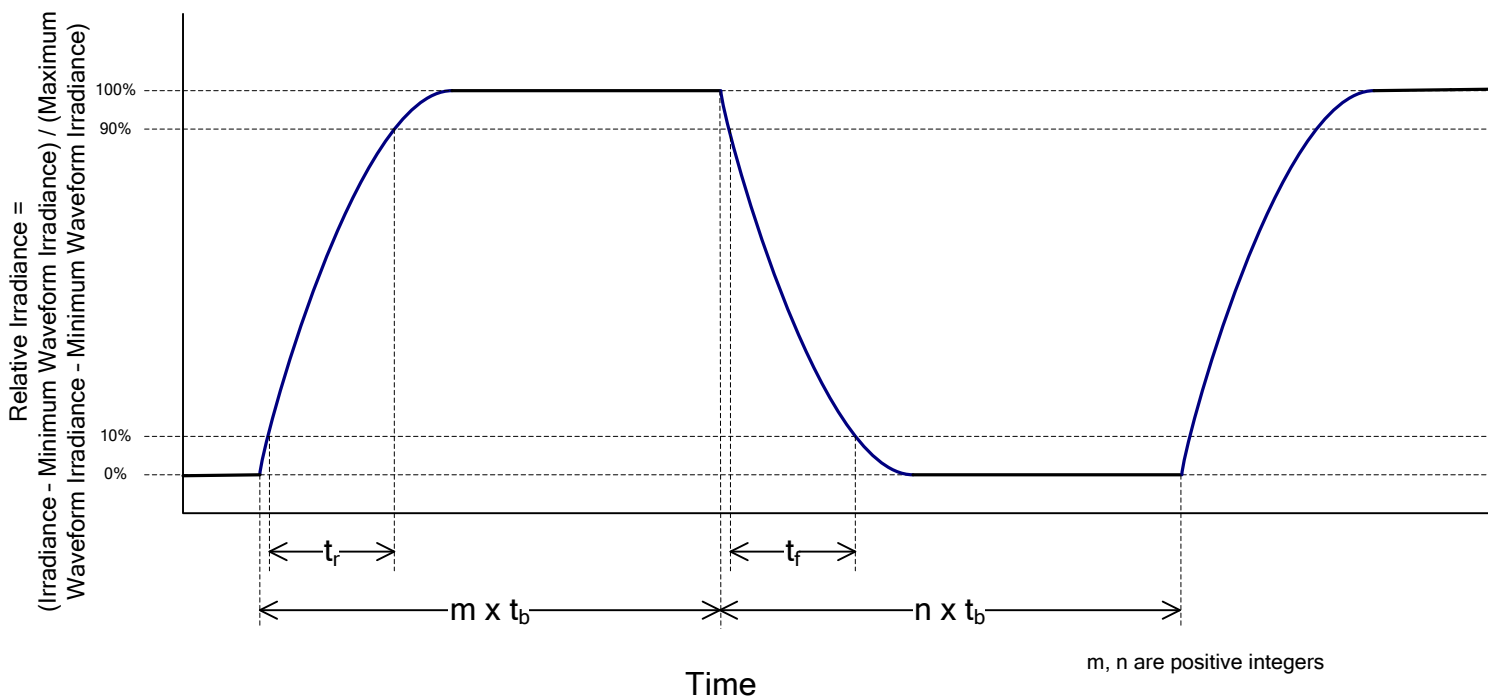

Figure 2 — SDVLC Modulation Waveform

8 Transmitter and Receiver Block Diagram

8.1 Transmitter to Receiver Link

In Figure 3, the modular structures of SDVLC system are shown. When data is to be transmitted, the data is encoded by the Data Encoding block. In the Modulation block, encoded data is used to modulate the optical output. The optical output is then transmitted to the Receiver. The Demodulation block of the Receiver demodulates the optical signal. The demodulated signal is then decoded by the Data Decoding block.

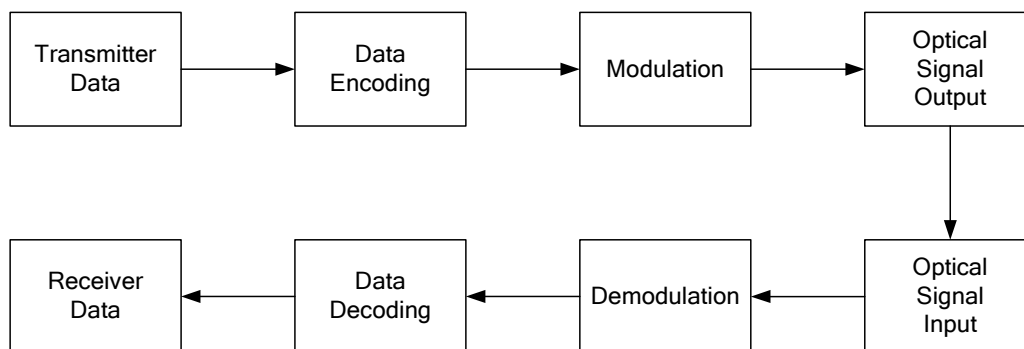

Figure 3 — Transmitter and Receiver block diagram

8.2 Data Encoding

SDVLC supports two different data encoding schemes. One of the data encoding schemes (8B/10B) allows the maximum data throughput but has a fixed optical link duty cycle of 50%. The other data encoding scheme (2B4B) has a lower data throughput but allows optical link duty cycles other than 50%.

8.2.1 8B10 Data Encoding

When using 8B/10B encoding, the SDVLC Transmitter shall use the 8B/10B encoding as specified in ISO/IEC 14165-251.

8.2.2 2B4B Data Encoding

In 2B4B encoding, the SDVLC Transmitter shall encode pairs of data bits into 4 bit symbols by selecting a row of Table 1. Note that which row is selected in Table 1 can be different for each pair of data bits, thus allowing for average duty cycles between 25% and 75%.

Table 1 — Data Encoding

		Data			
		(00)b	(01)b	(10)b	(11)b
Encoded Data Duty Cycle	25%	(0001)b	(0010)b	(0100)b	(1000)b
	50%	(0011)b	(0110)b	(1100)b	(1001)b
	75%	(1110)b	(1101)b	(1011)b	(0111)b

8.3 Modulation

The modulation of the optical link is On-Off Keying (OOK).

SDVLC may support a maximum of 16 different OOK f_m . The f_m of 120 MHz is mandatory. The f_m shall be at the specified frequency with a relative frequency tolerance of $\pm 20 \times 10^{-4}\%$ and a maximum peak jitter of 100 ps.

Bit duration time t_b (illustrated in Figure 2) is $1/f_m$.

8.4 Bit Order

The least significant bit of each symbol shall be transmitted first, while the most significant bit of each symbol shall be transmitted last.

9 Frame Formats

SDVLC transmissions shall be in the form of a sequence of frames, as shown in Figure 4. Each frame in the sequence is either a Data Frame or a Visible Frame.

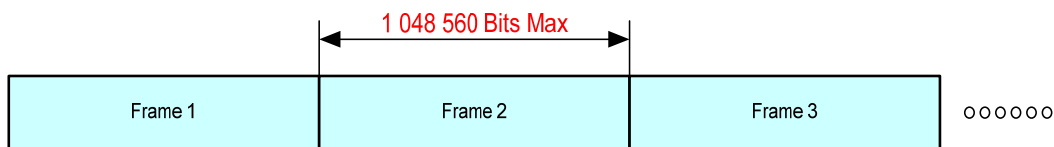

Figure 4 — Frame Sequence

9.1 Frame Structure overview

Two frame structures shall be used in SDVLC: a Data Frame structure, as specified in Figure 5, and a Visible Frame structure, as specified in Figure 6.

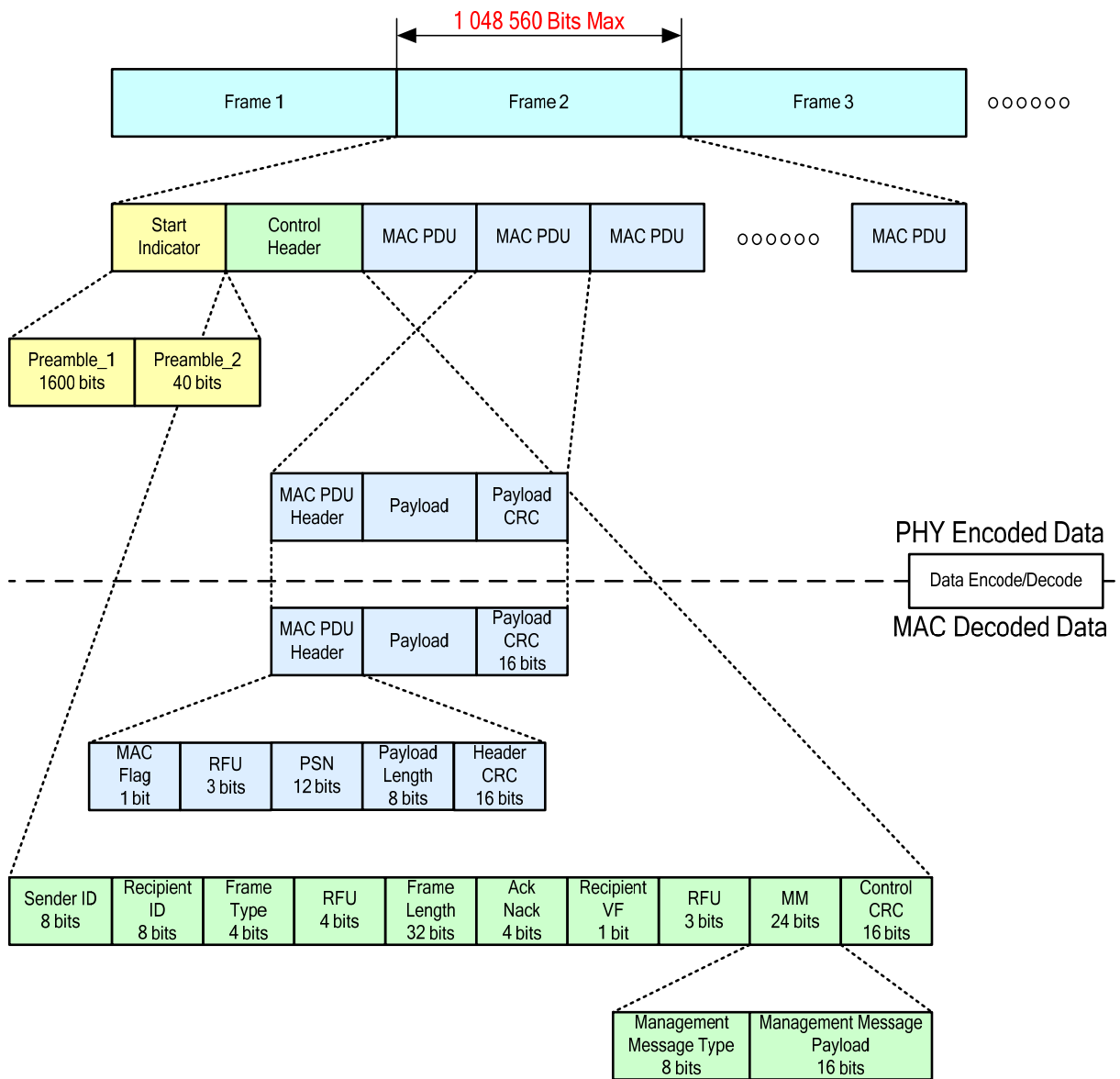

Figure 5 — Data Frame structure

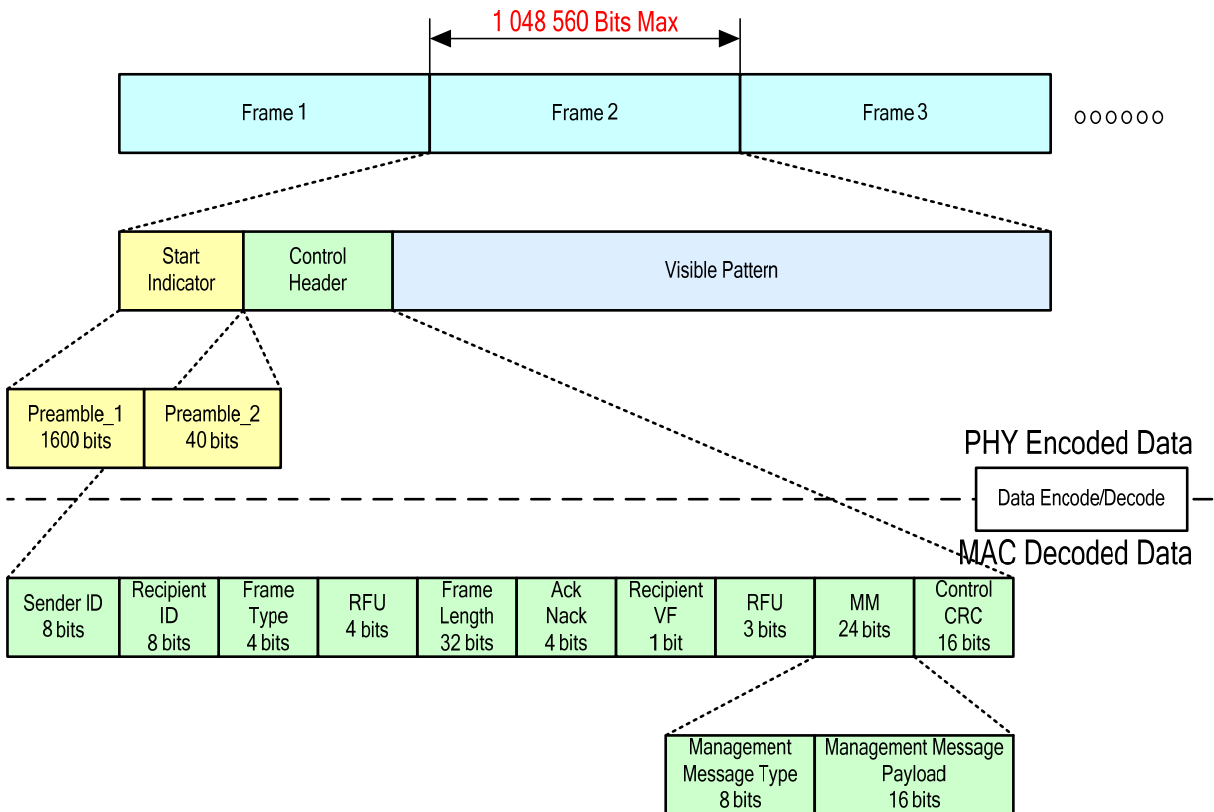

Figure 6 — Visible Frame structure

The choice of which frame structure to use may depend on the communication link status. When the communication link between Transmitter and Receiver is established with good alignment, the Data Frame structure is used for data communication. The Visible Frame structure is used to control the visible aspect of the communication beam to notify the user of a link failure (such as misalignment between the two devices) when the communication link between Transmitter and Receiver is not established. The decision of which frame structure to use may be made using the information in the control header, and when the communication link fails or becomes misaligned, the frame structure type may be changed.

The Visible Frame structure may be also used to cause the devices to show a beam while not transmitting data, thus making visible the communication link.

9.2 Frame Structure Detail

The frame structure for SDVLC shall consist of Start Indicator, Control Header, and either a series of one or more MAC PDUs or a Visible Pattern.

9.2.1 Start Indicator Structure

The Start Indicator structure shall consist of Preamble_1 and Preamble_2 as specified below.

Preamble_1 shall be (10)b repeated 800 times. Preamble_1 may be used by the Recipient to synchronize the receive data clock to the received data.

For 2B4B encoding, Preamble_2 shall be (11110000)b repeated five times. For 8B/10B encoding, Preamble 2 shall be the 8B/10B K28.1 symbol repeated four times. The Recipient shall check Preamble_2 field, and if Preamble_2 is not correct the Recipient shall consider a frame to not be started. Preamble_2 may be used by the Recipient for symbol synchronization to denote the end of the Preamble_1 and the start of PHY data.

9.2.2 Control Header Structure

After the symbol synchronization process using the Start Indicator completes, the control information shall be transmitted in the Control Header. The format of the Control Header is specified in Figure 7, and the contents of the Control Header are specified in Table 2. Reserved values shall not be used by a Sender. If a Recipient receives a Control Header that uses a reserved value it shall discard the Frame.

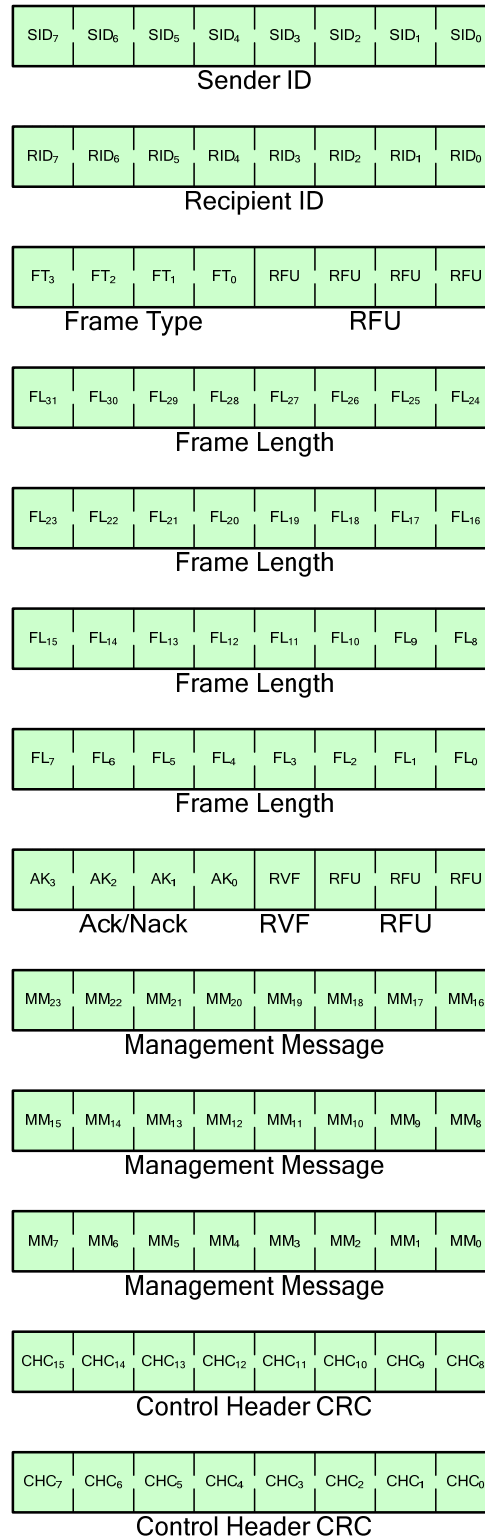

Figure 7 — Control Header structure

Table 2 — Control Header contents

Field Name	Description
Sender ID	Sender ID
Recipient ID	Recipient ID
Frame Type	0: Data frame 1: Visible frame 2-15: RFU
RFU	RFU
Frame Length	Length of Data Frame or Visible Frame, from the start of the Control Header through the end of the Frame, in bits.
Ack/Nack	0: No Ack/Nack 1: Nack 2: Ack 3-15: RFU
Recipient VF	1: Recipient may transmit visible frames 0: Recipient shall not transmit visible frames
RFU	RFU
Management Message	See 9.2.2.1
Control Header CRC	16-bit CRC of the Control Header from the Sender ID field through the MAC Management Message field; see 9.5 for the specification of the 16-bit CRC. The Recipient shall calculate the 16-bit CRC upon reception and compare the result to the value in this field; if the comparison fails the frame shall be discarded.

The Recipient shall send the status of receiving data to the Sender through the Ack/Nack bit assignments. When the Sender finishes transmitting the last bit of the frame, it shall start a timeout timer. If the Sender does not receive an Ack for a transmitted frame by the time the timeout timer reaches T_{ack} , it shall either retransmit the frame or drop the association. If the Sender receives a Nack for a transmitted frame, it shall either retransmit the frame or drop the association.

T_{ack} shall be 10 ms.

9.2.2.1 Management Message

Management messages start with an 8-bit Management Message Type field. Table 3 below shows the defined management message types in the Management Message Type field. When the Management Message Type is "0" or RFU, the Management Message Payload shall be discarded.

Table 3 — Management Message Type encoding

Type	Message name	Message description
0	Null	no management message
1	AS-REQ	Association Request message (see 11.1)
2	AS-RSP	Association Response message (see 11.2)
3	AS-ACK	Association Acknowledge message (see 11.3)
4	DAS-REQ	Disassociation Request message (see 11.4)
5	DAS-RSP	Disassociation Response message (see 11.5)
6	DAS-ACK	Disassociation Acknowledge message (see 11.3)
7	BR-REQ	Burst Request message (see 12.1.1)
8	BR-RSP	Burst Response message (see 12.1.2)
9	AB-REQ	Aperiodic Burst Request message (see 12.2.1)
10	AB-RSP	Aperiodic Burst Response message (see 12.2.2)
11	ENC-REQ	Data Encoding Change Request message (see 13.1)
12	ENC-RSP	Data Encoding Change Response message (see 13.2)
13-255	RFU	

9.3 MAC PDU Structure

The MAC PDU fields are described below.

9.3.1 MAC Header

The format of the MAC Header field is specified in Figure 8, and the contents of the MAC Header field are specified in Table 4.

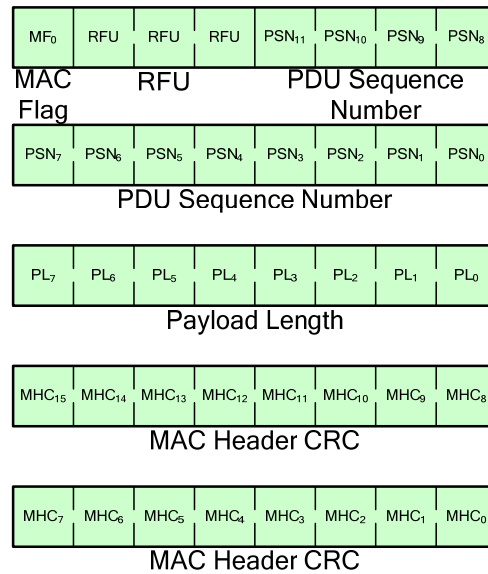

Figure 8 — MAC Header format

Table 4 — MAC Header contents

Field Name	Description
MAC Flag	ONE: another MAC PDU of the current SDU will follow ZERO: all other MAC PDUs.
RFU	RFU
PSN	PDU sequence number
Payload Length	Total length of Payload, in octets
MAC Header CRC	16-bit CRC of the MAC Header frame from the MAC Flag through the Length field; see 9.5 for the definition of the 16-bit CRC used. The Recipient shall calculate the 16-bit CRC upon reception and compare the result to the value in this field; if the comparison fails the frame shall be discarded.

The PSN field of the MAC Header shall be a modulo 2¹² counter that shall be used to distinguish each PDU in a Frame, using the value of zero for the first PDU in a frame and increasing the value in this field by 1 for each PDU in the Frame.

9.3.2 Payload

The Payload contains user data of variable length that shall be transmitted in the order as defined in RFC 791 Appendix B.

9.3.3 Payload CRC

The Payload CRC shall contain the 16-bit CRC over the Payload field. The 16-bit CRC shall be as defined in 9.5. The Recipient shall calculate the 16-bit CRC upon reception and compare the result to the value in this field; if the comparison fails the frame shall be discarded.

9.4 Visible Frame

The Visible Frame is used to control the perceived brightness of the Transmitter light. Controlling this perceived brightness allows the unit to communicate status to the person using the unit. A Visible Frame shall contain one Visible Pattern of variable size, limited only by the maximum size of the Visible Frame.

In order to avoid unnecessary flicker, devices may transmit Visible Frames when they are not transmitting Data Frames. As an example, Figure 9 shows a series of data transmissions from a Sender to a Recipient, and the Recipient sending back ACK status. The solid arrows show data and ACK transmissions, while the red dashed arrows show Visible Frame transmissions. Note that when the Sender and Recipient are not transmitting data or ACKs, they are transmitting Visible Frames.

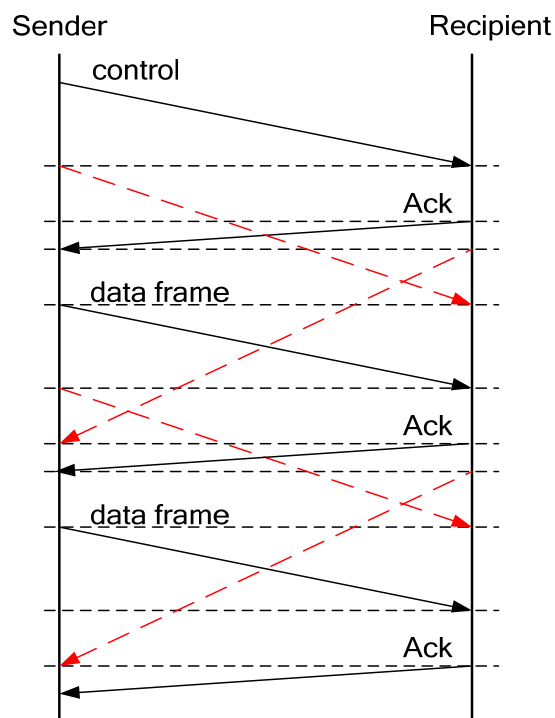

Figure 9 — Visible frame transmission and reception

9.4.1 Visible Pattern

The patterns used in the Visible Pattern shall not match codes that exist in the 8B/10B encoding system, nor shall they match the pattern used in Preamble_1 or Preamble_2.

A party shall not transmit a Visible Frame after the party has received a frame from an associated party that has the "Recipient VF" bit set to ZERO. A party may resume sending Visible Frames after it has received a frame from all associated parties that have the "Recipient VF" bit set to ONE.

When the Sender transmits a data frame to or receives a data frame from the Recipient, if a third party transmits a visible frame that is visible by the Sender, the Sender may experience interference in the link

between the Sender and Recipient. In this case, the Sender shall send a frame with “Recipient VF” bit set to 0 to the third party.

9.5 Cyclic Redundancy Check (CRC)

The CRC calculation used in SDVLC is a CRC-16 type CRC, and shall be the same algorithm as ISO/IEC 18092 (ECMA-340), Annex A, with the changes that the output shall be inverted and that the initial value bits shall be (10101100 11100001)b.

10 Connection Procedure

A SDVLC device initiates an association to establish a communication channel between two SDVLC devices. A SDVLC communication channel consists of two communication links, one in either direction, between the two devices in the association. Association is accomplished when the Initiator sends an AS-REQ message to the Target and the Initiator receives an AS-RSP from the Target in response. The Association procedure is specified in Figure 9 and the Disassociation procedure is specified in Figure 10.

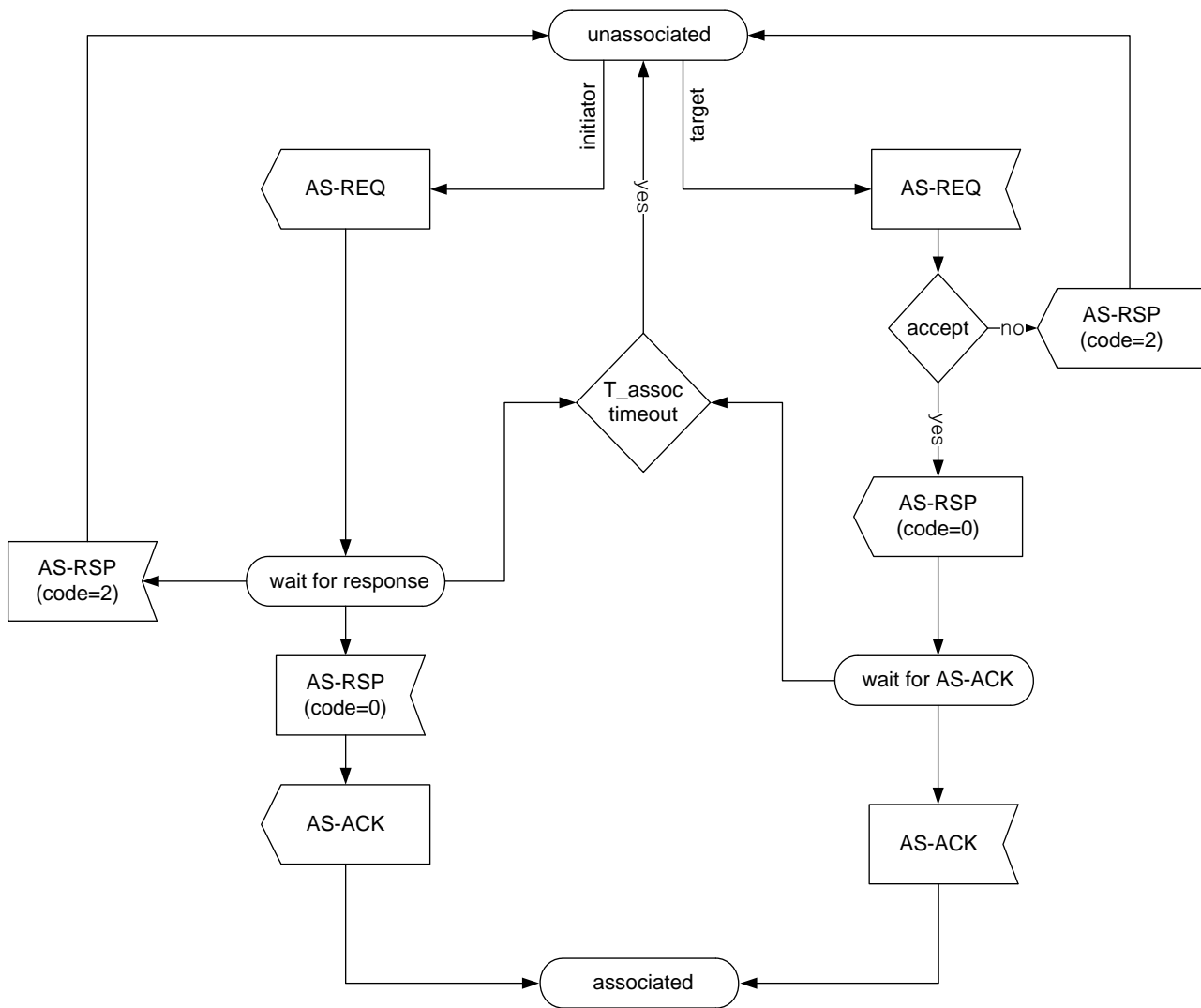

Figure 10 — Association SDL diagram

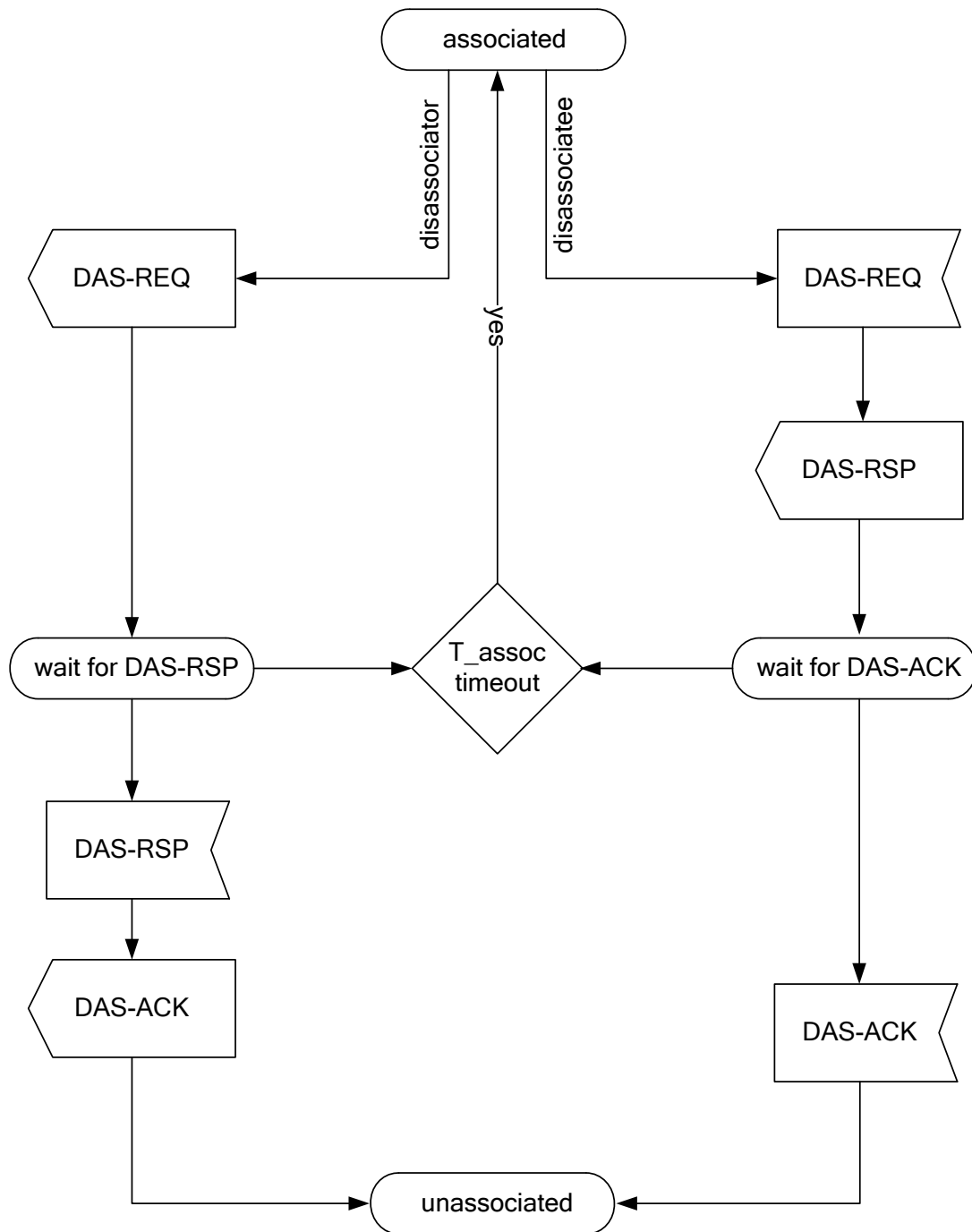

Figure 11 — Disassociation SDL diagram

T_{assoc} shall be 100 ms.

11 Association Operation Messages

11.1 Association Request (AS-REQ)

The format of the AS-REQ message is specified in Figure 12, and the contents of the AS-REQ message is specified in Table 5.



Management Message Type = 1

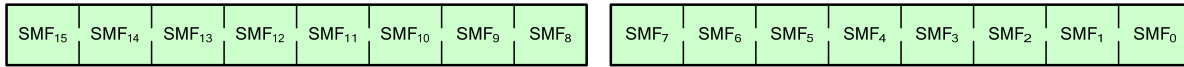

Supported Modulation Frequencies

Figure 12 — AS-REQ message format

Table 5 — AS-REQ message contents

Field Name	Description
Supported Modulation Frequencies bitmap	SR ₀ is always ONE: f _m = 120 Mbps is supported SR ₁ -SR ₁₅ : RFU

11.2 Association Response (AS-RSP)

The format of the AS-RSP message is specified in Figure 13, and the contents of the AS-RSP message is specified in Table 6.



Management Message Type = 2

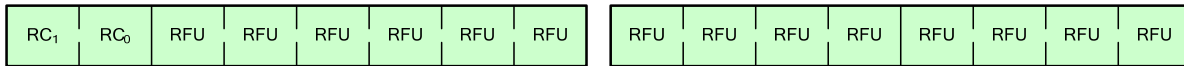

Response Code

RFU

RFU

Figure 13 — AS-RSP message format

Table 6 — AS-RSP message contents

Field Name	Description
Response Code	0: success 1: already associated 2: association rejected 3: unknown failure
RFU	RFU

11.3 Association Acknowledge (AS-ACK)

The format of the AS-ACK message is specified in Figure 14, and the contents of the AS-ACK message are specified in Table 7.



Management Message Type = 3

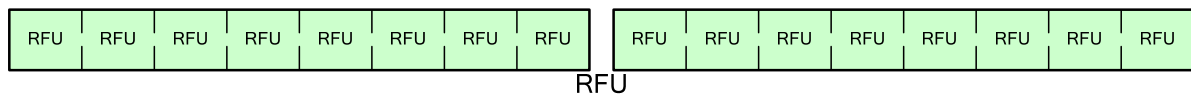

RFU

Figure 14 — AS-ACK message format

Table 7 — AS-ACK message contents

Field Name	Description
RFU	RFU

11.4 Disassociation Request (DAS-REQ)

The format of the DAS-REQ message is specified in Figure 15, and the contents of the DAS-REQ message is specified in Table 8.



Management Message Type = 4

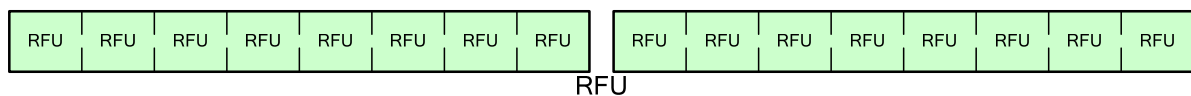

RFU

Figure 15 — DAS-REQ message format

Table 8 — DAS-REQ message contents

Field Name	Description
RFU	RFU

11.5 Disassociation Response (DAS-RSP)

The format of the DAS-RSP message is specified in Figure 16, and the contents of the DAS-RSP message are specified in Table 9.



Management Message Type = 5

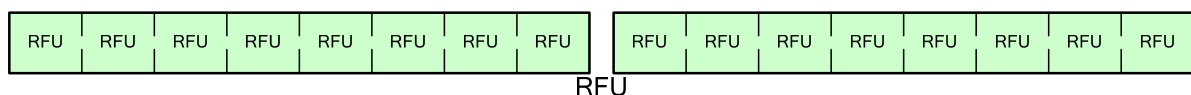

RFU

Figure 16 — DAS-RSP message format

Table 9 — DAS-RSP message contents

Field Name	Description
RFU	RFU

11.6 Disassociation Acknowledge (DAS-ACK)

The format of the DAS-ACK message is specified in Figure 17, and the contents of the DAS-ACK message are specified in Table 10.

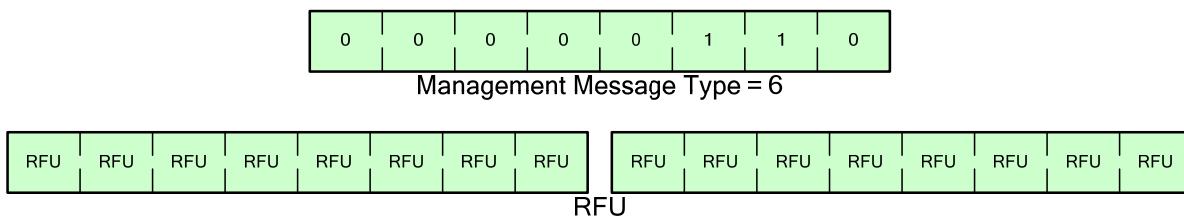

Figure 17 — DAS-ACK message format

Table 10 — DAS-ACK message contents

Field Name	Description
RFU	RFU

12 Data Burst Modes Operation

When a device has multiple other devices in the field of view, the device shall manage the other devices to ensure that interference does not happen. In order to minimize interference and reduce power consumption, the device will have to manage the other devices using schedules. A device in an association (known as the Burst Master) sets the Burst mode schedule while the other device in an association (known as the Burst Slave) is working according to the schedule.

SDVLC supports two Burst modes: Periodic Burst Mode and Aperiodic Burst Mode.

Data Frames shall not be transmitted while the device is in a Data Quiet window.

VF Mode Stop is negotiated between the Burst Master and the Burst Slave using the VF Mode Stop Request and VF Mode Stop Approve bits. If VF Mode Stop is approved, then both the Burst Master and the Burst Slave shall not send Visible Frames during Burst mode.

12.1 Periodic Burst Mode

Periodic Burst Mode allows the Burst Master and the Burst Slave the opportunity to enter a Burst state on a periodic basis. The Burst parameters that are defined at the beginning of the Burst mode are used throughout the Burst mode to define the Burst window and the Data Quiet window; thus the Burst windows are all the same duration and all the Data Quiet windows are the same duration during an instance of periodic Burst mode.

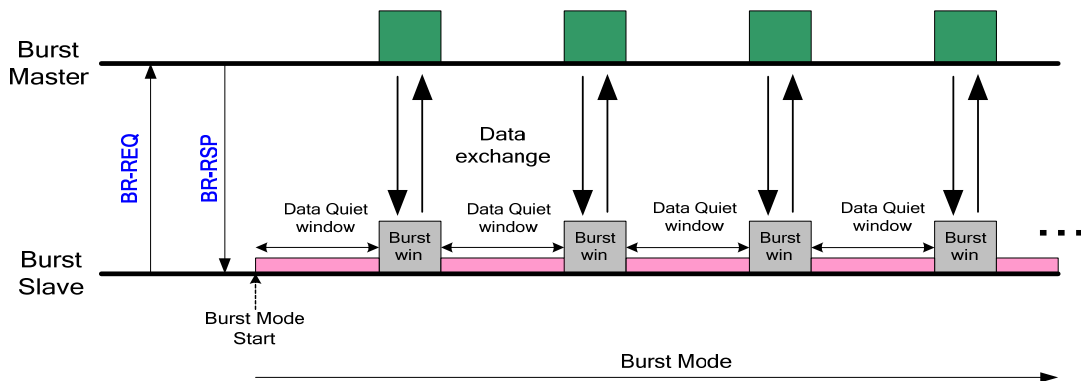

Figure 18 — Periodic Burst Mode

After receiving a BR-REQ from the Burst Slave, the Burst Master shall send a BR-RSP to the Burst Slave. The BR-RSP contains Burst window size and Data Quiet window size.

To exit from the Periodic Burst Mode, either the Burst Slave shall send a BR-REQ with the Operation field set to 0 or the Burst Master shall send a BR-RSP with the Operation field set to 0.

12.1.1 Burst Request Message (BR-REQ)

The Burst Slave may send a BR-REQ to the Burst Master. The format of the BR-REQ message is specified in Figure 19, and the contents of the BR-REQ message are specified in Table 11.

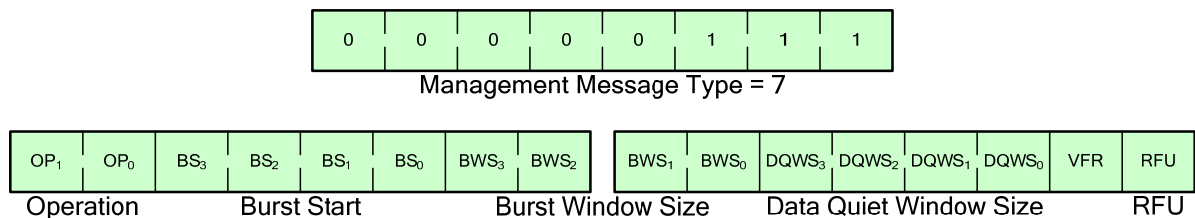

Figure 19 — BR-REQ message format

Table 11 — BR-REQ message contents

Field Name	Description
Operation	0 = Burst deactivation request 1 = Burst activation request 2 = RFU 3 = RFU
Burst Start	If the Operation field is 1 then the Burst Start field is set to the time to first Burst window (in units of 5 ms) If the Operation field is other than 1 then the Burst Start field is set to 0 by Burst Slave and ignored by Burst Master
Burst Window Size	If the Operation field is 1 then the Burst Window Size field is set to the size of the burst window (in units of 5 ms) If the Operation field is other than 1 then the Burst Window Size field is set to 0 by Burst Slave and ignored by Burst Master
Data Quiet Window Size	If the Operation field is 1 then the Data Quiet Window Size field is set to the size of the data quiet window (in units of 5 ms) If the Operation field is other than 1 then the Data Quiet Window Size field is set to 0 by Burst Slave and ignored by Burst Master
VF Mode Stop Request	If the Operation field is 1 and VF Mode Stop Request is 1 then VF mode stop is requested If the Operation field is 1 and VF Mode Stop Request is 0 then VF mode stop is not requested If the Operation field is other than 1 then VF Mode Stop Request is set to 0 by Burst Slave and ignored by Burst Master
RFU	RFU

12.1.2 Burst Response Message (BR-RSP)

The Burst Master shall send a BR-RSP to the Burst Slave as a response to a BR-REQ. The Burst Slave executes Burst mode based on the information in the received BR-RSP. The format of the BR-RSP message is specified in Figure 20, and the contents of the BR-RSP message are specified in Table 12.

The parameters in the BR-RSP message shall supersede the parameters in the corresponding BR-REQ message. To reject the parameters, the Burst Slave shall send a BR-REQ message with the Operation Field set to 0 to abort Burst mode.

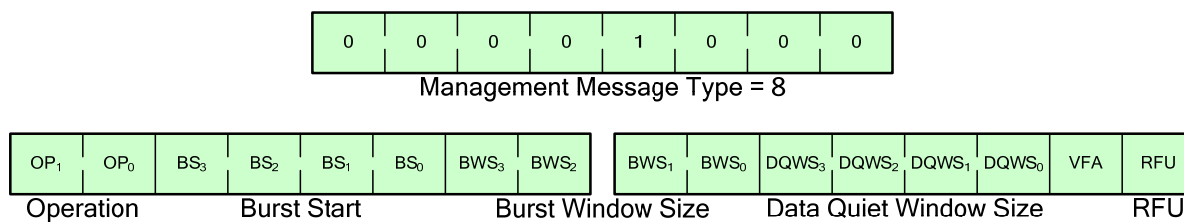

Figure 20 — BR-RSP message format

Table 12 — BR-RSP message contents

Field Name	Description
Operation	<p>0 = Approved, deactivation of Burst Mode</p> <p>1 = Approved, activation of Burst Mode</p> <p>2 = Not approved</p> <p>3 = RFU</p>
Burst Start	<p>If the Operation field is 1 then the Burst Start field is set to the time to first burst window (in units of 5 ms)</p> <p>If the Operation field is other than 1 then the Burst Start field is set to 0 by Burst Master and ignored by Burst Slave</p>
Burst Window Size	<p>If the Operation field is 1 then the Burst Window Size field is set to the burst window size (in units of 5 ms)</p> <p>If the Operation field is other than 1 then the Burst Window field is set to 0 by Burst Master and ignored by Burst Slave</p>
Data Quiet Window Size	<p>If the Operation field is 1 then the Data Quiet Window Size field is set to the data quiet window size (in units of 5 ms)</p> <p>If the Operation field is other than 1 then the Data Quiet Window Size field is set to 0 by Burst Master and ignored by Burst Slave</p>
VF Mode Stop Approve	<p>If the Operation field is 1 and VF Mode Stop Approve is 1 then VF mode stop is approved</p> <p>If the Operation field is 1 and VF Mode Stop Approve is 0 then VF mode stop is not approved</p> <p>If the Operation field is other than 1 then VF Mode Stop Approve is set to 0 by Burst Master and ignored by Burst Slave</p>
RFU	RFU

12.2 Aperiodic Burst Mode

Aperiodic Burst Mode allows the Burst Master and the Burst Slave the opportunity to enter a Burst state on a non-periodic basis. The Burst parameters are redefined for each Burst window and Data Quiet window of the Aperiodic Burst Mode instance. The Burst Master shall send an ABR-RSP message during each listen window that contains the parameters for the next Burst window and Data Quiet window.

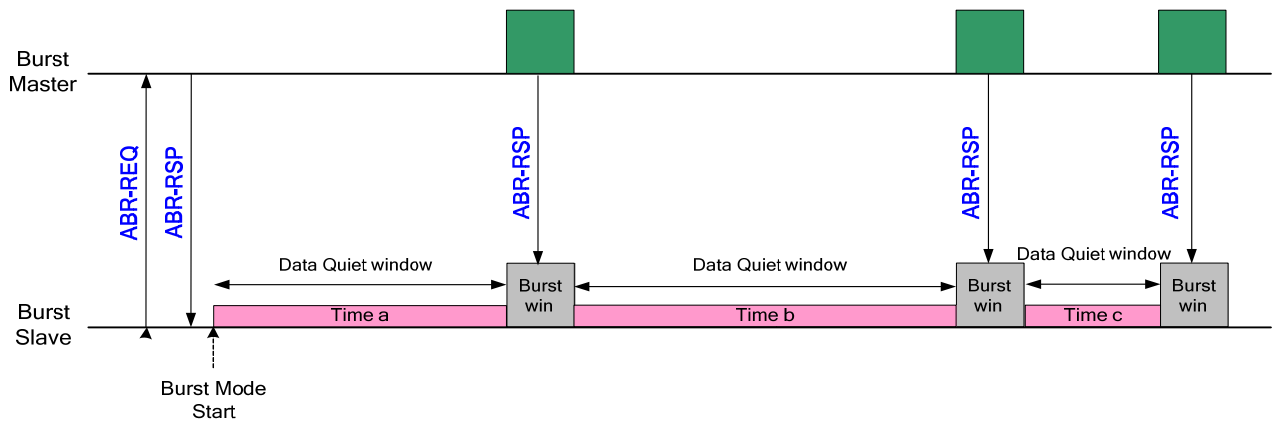

Figure 21 — Aperiodic Burst Mode Service

12.2.1 Aperiodic Burst Request Message (ABR-REQ)

The Burst Slave may send an ABR-REQ to the Burst Master. The format of the ABR-REQ message is specified in Figure 22, and the contents of the ABR-REQ message are specified in Table 13.

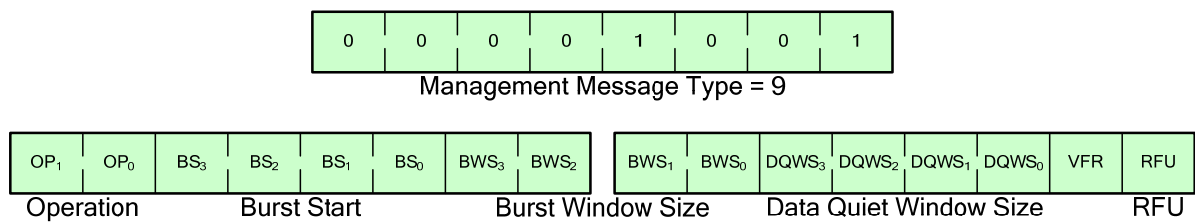

Figure 22 — ABR-REQ message format

Table 13 — ABR-REQ message contents

Field Name	Description
Operation	0 = Burst deactivation request 1 = Burst activation request 2 = RFU 3 = RFU
Burst Start	If the Operation field is 1 then the Burst Start field is set to the time to first Burst window (in units of 5 ms) If the Operation field is other than 1 then the Burst Start field is set to 0 by Burst Slave and ignored by Burst Master
Burst Window Size	If the Operation field is 1 then the Burst Window Size field is set to the size of the burst window (in units of 5 ms) If the Operation field is other than 1 then the Burst Window Size field is set to 0 by Burst Slave and ignored by Burst Master
Data Quiet Window Size	If the Operation field is 1 then the Data Quiet Window Size field is set to the size of the data quiet window (in units of 5 ms) If the Operation field is other than 1 then the Data Quiet Window Size field is set to 0 by Burst Slave and ignored by Burst Master
VF Mode Stop Request	If the Operation field is 1 and VF Mode Stop Request is 1 then VF mode stop is requested If the Operation field is 1 and VF Mode Stop Request is 0 then VF mode stop is not requested If the Operation field is other than 1 then VF Mode Stop Request is set to 0 by Burst Slave and ignored by Burst Master
RFU	RFU

12.2.2 Aperiodic Burst Response Message (ABR-RSP)

The Burst Master shall send an ABR-RSP to the Burst Slave as a response to an ABR-REQ. The Burst Slave executes Burst mode based on the information in the received ABR-RSP. The format of the ABR-RSP message is specified in Figure 23, and the contents of the ABR-RSP message is specified in Table 14.

The parameters in the ABR-RSP message shall supersede the parameters in the corresponding ABR-REQ message. To reject the parameters, the Burst Slave shall send an ABR-REQ message with the Operation Field set to 0 to abort Burst mode.

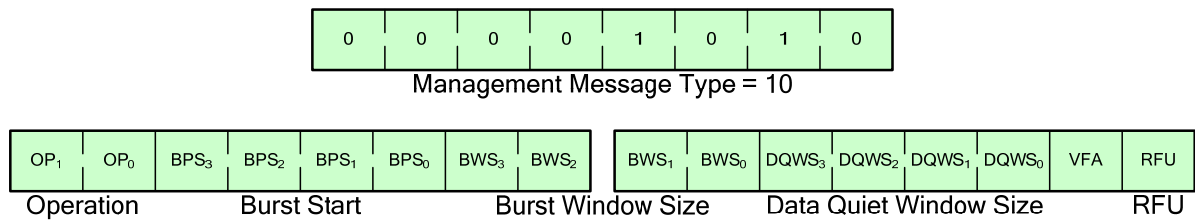

Figure 23 — ABR-RSP message format

Table 14 — ABR-RSP message contents

Field Name	Description
Operation	<p>0 = Approved, deactivation of Burst Mode</p> <p>1 = Approved, activation of Burst Mode</p> <p>2 = Not approved</p> <p>3 = RFU</p>
Burst Start	<p>If the Operation field is 1 then the Burst Start field is set to the time to first burst window (in units of 5 ms)</p> <p>If the Operation field is other than 1 then Burst Start is set to 0 by Burst Master and ignored by Burst Slave</p>
Burst Window Size	<p>If the Operation field is 1 then the Burst Window Size field is set to the burst window size (in units of 5 ms)</p> <p>If the Operation field is other than 1 then Burst Window is set to 0 by Burst Master and ignored by Burst Slave</p>
Data Quiet Window Size	<p>If the Operation field is 1 then the Data Quiet Window Size field is set to the data quiet window size (in units of 5 ms)</p> <p>If the Operation field is other than 1 then the Data Quiet Window Size field is set to 0 by Burst Master and ignored by Burst Slave</p>
VF Mode Stop Approve	<p>If the Operation field is 1 and VF Mode Stop Approve is 1 then VF mode stop is approved</p> <p>If the Operation field is 1 and VF Mode Stop Approve is 0 then VF mode stop is not approved</p> <p>If the Operation field is other than 1 then VF Mode Stop Approve is set to 0 by Burst Master and ignored by Burst Slave</p>
RFU	RFU

13 Data Encoding Change

SDVLC defines two data encodings: 8B/10B and 2B4B. All associations shall be established using 8B/10B data encoding; after association is established the data encoding may be changed. To switch data encodings, the ENC-REQ and ENC-RSP commands shall be used.

The ENC-REQ and ENC-RSP commands shall be sent with the current data encoding. Subsequent frames sent after the ENC-RSP command shall use the data encoding specified in the ENC-RSP command.

13.1 ENC-REQ (Data Encoding Change Request)

ENC-REQ is used to request a change in the Data Encoding. The format of the ENC-REQ message is specified in Figure 24, and the contents of the ENC-REQ message are specified in Table 15.

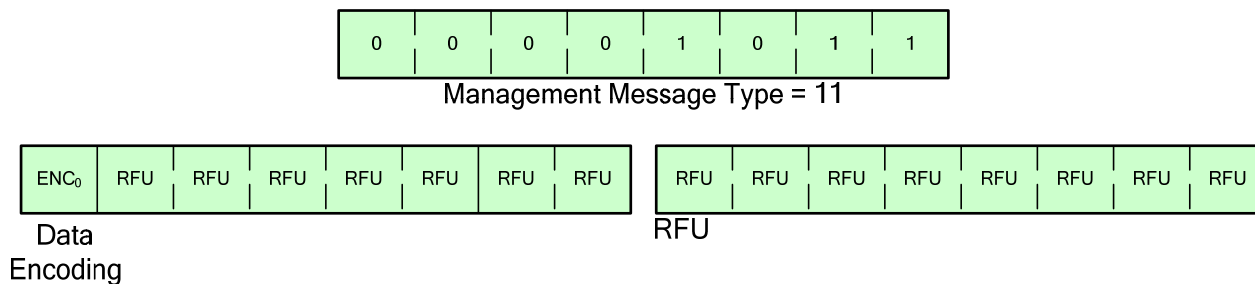

Figure 24 — ENC-REQ message format

Table 15 — ENC-REQ message contents

Field Name	Description
Data Encoding	0: 8B/10B Data Encoding 1: 2B4B Data Encoding
RFU	RFU

13.2 ENC-RSP (Data Encoding Change Response)

The ENC-RSP message is used to respond to the ENC-REQ message. The format of the ENC-RSP message is specified in Figure 25, and the contents of the ENC-RSP message are specified in Table 16.

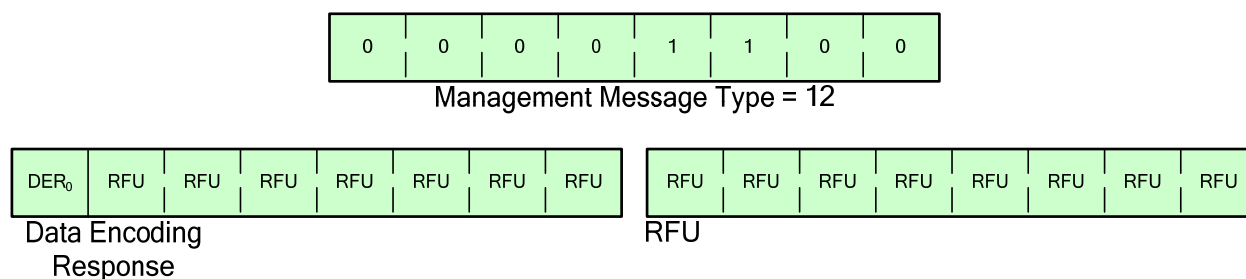

Figure 25 — ENC-RSP message format

Table 16 — ENC-RSP message contents

Field Name	Description
Data Encoding Response	0: Data Encoding Request Denied 1: Data Encoding Request Accepted
RFU	RFU

